

For more information on Zehnder go to [www.barbourproductsearch.info](http://www.barbourproductsearch.info)

**zehnder** *multicolumn*  
*multicolumn completto*  
*multicolumn klinik*

**zehnder**



**Subject to technical changes.**

**© Copyright Zehnder Ltd**

All rights, especially those of reproduction, dissemination and translation, are reserved.

No part of this publication may be reproduced in any form or by any means (printing, photocopying, microfilm, scanning or otherwise), or electronically processed, duplicated, stored or distributed without the prior written approval of Zehnder Group.

Table of contents



**zehnder** *multicolumn, multicolumn completto, multicolumn klinik*

General technical information .....	4
Product overview .....	6
Product description .....	7
Technical data:	
– <b>zehnder</b> <i>multicolumn, multicolumn completto</i> .....	9
– <b>zehnder</b> <i>multicolumn klinik</i> .....	12
Pressure loss .....	14
Connection options .....	15
Couplings / Fixing provisions .....	17
Overall radiator lengths .....	18
Fixing provisions .....	19
Special versions .....	22
Special configurations .....	23
Heat capacity / technical data per element:	
<b>zehnder</b> <i>multicolumn, multicolumn completto</i>	
– Height 177–260 mm .....	24
– Height 292–350 mm .....	25
– Height 392–450 mm .....	26
– Height 492–550 mm .....	27
– Height 592–750 mm .....	28
– Height 892–1000 mm .....	29
– Height 1092–1200 mm .....	30
– Height 1492–1800 mm .....	31
– Height 1992–2200 mm .....	32
– Height 2492–2800 mm .....	33
– Height 2992–3000 mm .....	34
<b>zehnder</b> <i>multicolumn klinik</i>	
– Height 177–260 mm .....	35
– Height 292–350 mm .....	36
– Height 392–450 mm .....	37
– Height 492–550 mm .....	38
– Height 592–750 mm .....	39
Conversion factors .....	40
Configuration examples .....	42

General technical information



Sizes, units of measurement, symbols (EN 442)

Symbol	Unit	Description
H	mm	Height
L	mm	Length
T	mm	Depth
H Lam.	mm	Height of fins
N	mm	Distance between connections
A	m <sup>2</sup>	Surface area
V	dm <sup>3</sup>	Water capacity
M	kg	Empty weight
E	-	Number of elements
t <sub>1</sub>	°C	Flow temperature
t <sub>2</sub>	°C	Return temperature
t <sub>r</sub>	°C	Room temperature
t <sub>m</sub>	°C	Mean water temperature $\frac{t_1 + t_2}{2}$
ΔT	K	Temperature difference t <sub>m</sub> - t <sub>r</sub>
Φ	W=(J/s)	Heat capacity
Φ <sub>S</sub>	W	Nominal heat emission
Φ <sub>L</sub>	W	Nominal heat emission per module
c <sub>p</sub>	J/kg K	Mean specific heat capacity
n	-	Radiator characteristic, exponent
s <sub>k</sub>	%	Percentage of emission by radiation
c <sub>K</sub>	-	Correction factor to Φ <sub>S</sub>
q <sub>m</sub>	kg/h/(kg/s)	Water flow
q <sub>ms</sub>	kg/h/(kg/s)	Normal water flow
v	m/s	Speed
Δp	kPa	Pressure loss, pressure drop
ζ	-	Coefficient of resistance

Heat capacity Φ

The heat emission of a radiator model is determined from the nominal characteristics:

$$\Phi = K_M \cdot \Delta T^n \quad \text{where } K_M \text{ is the constant for the model.}$$

According to the new standard SIA 384.502 (EN442-2), the temperature difference is calculated from the arithmetic mean between the flow and return temperatures and the reference air temperature.

$$\Delta T = \frac{t_1 + t_2}{2} - t_r$$

Temperature difference ΔT

The heat emission for temperature differences ΔT other than the nominal temperature difference ΔT = 50 K can therefore be calculated from the equation

$$\Phi = \Phi_S \left( \frac{\Delta T}{50K} \right)^n$$

Example of the heat emission calculation for Φ

- Φ<sub>S</sub> = 459 W
- Exponent n = 1.24
- t<sub>1</sub> = 60 °C
- t<sub>2</sub> = 40 °C
- t<sub>r</sub> = 15 °C

$$\Delta T = \frac{60^\circ\text{C} + 40^\circ\text{C}}{2} - 15^\circ\text{C} = 35\text{K}$$

$$\Phi = 459 \text{ W} \left( \frac{35\text{K}}{50\text{K}} \right)^{1.24} = 459 \text{ W} \cdot 0.6426 = 295 \text{ W}$$

General

Technical details such as dimensions, weights, heat surfaces always relate to the standard model of the specific product. This information is applicable only to radiators with an overall length of 1000 mm. For other lengths, the influence of the couplings and/or header tubes must be taken into consideration.

The heat emission figures are valid for connections on the same end. The influence of other connection types is described in the technical literature. We will be pleased to provide you with information regarding specific cases.



On the 1<sup>st</sup> January 1998, the new European standards EN 442-1 to 442-3 came into force as Swiss standards SIA 384.501, SIA 384.502 and SIA 384.503.

This recommendation was accepted by most of the European countries including Switzerland.

It prescribes the test procedures and measuring methods to be followed in similarly equipped test laboratories. Thus, one single measuring procedure, valid for the whole of Europe, has replaced the measuring methods, which varied from country to country hitherto.

**General technical information**



**Nominal water flow  $q_{ms}$**

(heating medium flow, flow-through quantity, mass flow)

The nominal water flow  $q_{ms}$  of a radiator results in a temperature spread of 10K with a flow temperature of 75 °C (nominal heat emission conditions).

$$\text{Therefore } q_{ms} = \frac{\Phi}{c_p (t_1 - t_2)} \quad c_p \approx 4187 \frac{\text{J}}{\text{kg}\cdot\text{K}}$$

The actual water flow  $q_m$  of a radiator can differ considerably from the nominal water flow  $q_{ms}$  with flow and return temperatures other than 75/65 °C.

**Case 1:**

**Runtal Jet**  
 $\Phi_S = 459 \text{ W}$   
 Model RH42-1000  
 Temperatures: 75/65/20 °C

$$q_{ms} = \frac{459}{4187(75 - 65)} \quad q_{ms} = 0.011 \text{ kg/s} \approx 39.5 \text{ kg/h}$$

**Case 2:**

**Runtal Jet**  
 $\Phi_S = 239 \text{ W}$   
 Model RH42-1000  
 Temperatures: 55/40/18 °C

$$q_{ms} = \frac{239}{4187(55 - 40)} \quad q_{ms} = 0.0038 \text{ kg/s} \approx 13.7 \text{ kg/h}$$

The actual water flow  $q_m$  as a % of  $q_{ms}$  in Case 2 is therefore :

$$\frac{q_m}{q_{ms}} \text{ as a \%}$$

$$\frac{13.7}{39.5} \text{ as a \%}$$

$q_m$  is therefore 35%  $q_{ms}$

The minimum according to the table is 20%.  
 Case 2 fulfils the minimum water flow requirements.

**Minimum water flow  $q_{m \text{ min.}}$**

The series of measurements that we have carried out has indicated that individual radiators react differently to deviations in the nominal water flow  $q_{ms}$  and that, for water flows below certain minimum water flows  $q_{m \text{ min.}}$ , it is difficult to make reliable statements about the heat emission. With constructional measures, operation with smaller water flows  $q_m$  is often made possible.

We will be pleased to be of assistance in specific cases; critical applications can be tested in our laboratory. The following table indicates the minimum water flows  $q_m$  as a % of the nominal water flows  $q_{ms}$ , which under normal circumstances should not be lessened:

Radiators	$q_m$ as % of $q_{ms}$
- <b>runtal jet</b> panel radiator (horizontal model)	20 %
- <b>runtal jet</b> panel radiator (vertical model)	17 %
- Multicolumn <b>zehnder multicolumn</b>	17 %
- <b>runtal RX</b> flat-oval radiator	17 %
- <b>zehnder radiavector</b>	30 %

Bathroom radiators	$q_m$ as % of $q_{ms}$
<b>zehnder universal, toga</b>	27 %

Overview of radiator types

**zehnder** *multicolumn, multicolumn complete, multicolumn klinik*



**zehnder** *multicolumn*

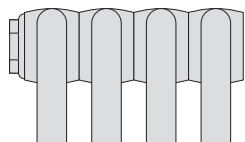

Section spacing 46 mm



2-column

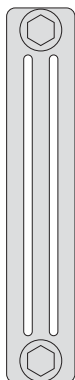

3-column

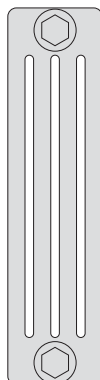

4-column

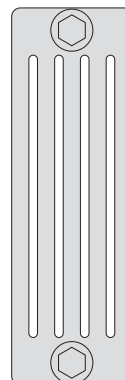

5-column

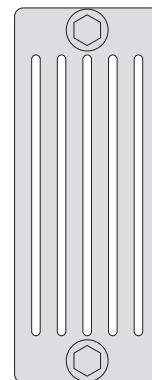

6-column

**zehnder** *multicolumn complete*

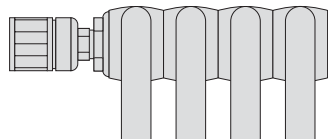

Section spacing 46 mm



C 2-column

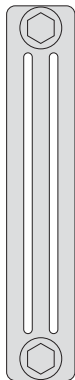

C 3-column

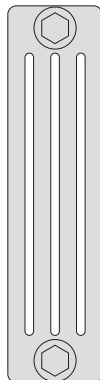

C 4-column

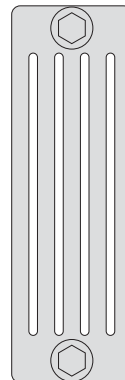

C 5-column

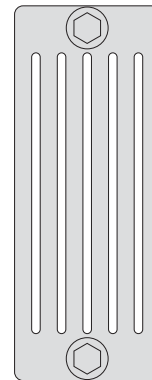

C 6-column

**zehnder** *multicolumn klinik*

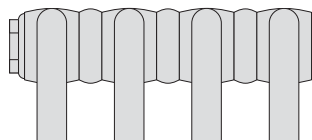

Section spacing 65 mm



K 2-column

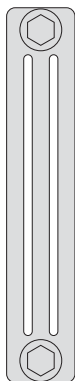

K 3-column

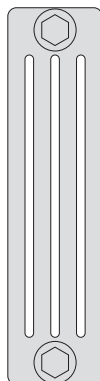

K 4-column

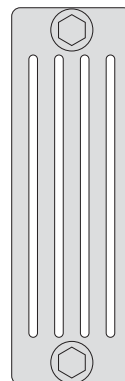

K 5-column

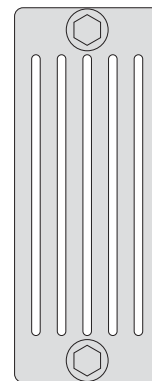

K 6-column

**Product description**



**zehnder** *multicolumn, multicolumn completto, multicolumn klinik*

**General**

The **zehnder** *multicolumn* radiator consists of a number of steel-tube sections that are permanently welded together.

The **zehnder** *multicolumn completto* and **zehnder** *multicolumn klinik* models are special versions of the **zehnder** *multicolumn*.

The Zehnder multicolumn radiators have been highly commended by the Heinrich Heine University of Düsseldorf, Germany, for their compliance with stringent hygiene requirements.

The **zehnder** *multicolumn completto* has a factory-installed control valve (type UNI-A) built into its top connection element. The **zehnder** *multicolumn klinik* radiator consists of a number of steel-tube sections with 19 mm spacers arranged adjacently and permanently welded. The resulting increased section spacing greatly simplifies cleaning operations. This type of radiator is recommended for use in clinics and sanatoria, as well as in health and fitness centres.

**Materials used**

Header (wall thickness)	1.5 mm
Round tubing	25 dia. x 1.25 mm

**Special features**

- suitable for low temperature systems
- high heat radiation percentage
- good energy balance
- wide range of special versions available
- high pressure resistance
- no sharp edges or corners
- suitable for locations with high hygiene requirements
- easy to clean

**Application**

A classic among radiators, whose timeless elegance and practical features make it suitable for installation in most locations.

**Dimensions**

The length of the multi-column radiators is virtually unlimited. Depending on their weights and lengths, certain radiators are supplied in separate parts. The overall lengths do not always correspond exactly to the dimensions in the catalogue. Such differences are unavoidable, due to the manufacturing method used. An average overall length discrepancy of between +0.5% and -1% must be allowed for.

**Important: remember transport limitations!**

The British Standard Code of Practice BS7593: 1992 Treatment of Water in Hot Water Central Heating Systems, should be observed when installing a system.

All Zehnder products are supplied with a 2 year warranty on materials and manufacture. However, this may be invalidated should adequate water treatment not be applied during installation and throughout the life of the system.

**Test pressure**

<b>zehnder</b> <i>multicolumn, multicolumn klinik:</i>	
2-4 columns	15.6 bar
5-6 columns	13.0 bar
<b>zehnder</b> <i>multicolumn completto</i>	13.0 bar

**Operating pressure (EN 442)**

<b>zehnder</b> <i>multicolumn, multicolumn klinik:</i>	
2-4 columns	12.0 bar max.
5-6 columns	10.0 bar max.
<b>zehnder</b> <i>multicolumn completto</i>	10.0 bar max.

**Operating temperature**

<b>zehnder</b> <i>multicolumn, multicolumn klinik:</i>	120 °C max.
<b>zehnder</b> <i>multicolumn completto</i>	120 °C max.

**Basic delivery schedule for standard delivery**

Supplied ready-to-install with 2,3 or 4 end-connectors for flow, return, venting and draining. Stove-enamelled in white RAL 9016 standard gloss finish, with transport packaging.

**Special versions**

- zehnder** *multicolumn, multicolumn completto, multicolumn klinik*
- curved and angled versions on request and according to drawing
- intermediate overall heights
- adjustable and non-adjustable support legs (standard or according to drawing)
- zehnder** *multicolumn, multicolumn klinik*
- connections for two-pipe system
- connections for one-pipe system
- zehnder** *multicolumn*
- version with hot water insert (on request)
- zehnder** *multicolumn completto*
- valve located underneath (on request)
- zehnder** *multicolumn klinik*
- overall heights greater than 750 mm (on request)

**Stove-enamelling**

Standard version RAL 9016 pure white

Slight colour differences versus the original RAL or NCS colours are possible, due to varying glazes and other production processes.

**Product description**



**zehnder** *multicolumn, multicolumn completo, multicolumn klinik*

**Galvanizing**

Zehnder offers 2 galvanizing treatments for multi-columns: Electro galvanizing or hot-dip.

Electro galvanizing, which achieves a perfectly smooth finish, is available for radiators with maximum dimensions of 1200 x 6000mm. It requires a stove enameled finish over the galvanic treatment.

Hot-dip galvanizing is available for radiators with maximum dimensions of 2500 x 6000mm. Because the resulting surface will be uneven, it is not recommended for stove enameling after the galvanic treatment.

Guarantee: Our standard 2-year guarantee applies only if the installation is outside of spraying areas from showers and toilets. (See DIN 55 900/2) No guarantee can be given where the installation is in areas with corrosive atmospheres and where the impact of pollution is unknown, e.g. swimming pools and factories

Delivery: standard lead time + 3 weeks

**Number of elements**

The maximum number of elements assembled at the factory (due to transport and weight constraints):

**Overall lengths of zehnder multicolumn:**

Model	Overall Height mm	Overall Length mm	Number of sections
<b>2-column</b>	177– 892	2944	64
	1092–2992	920	20
<b>3-column</b>	185– 900	2944	64
	1000–3000	920	20
<b>4-column</b>	200– 900	2760	60
	1000–3000	920	20
<b>5-column</b>	200– 900	2530	55
	1000–3000	782	17
<b>6-column</b>	200– 900	2116	46
	1000–3000	664	14

**Overall lengths of zehnder multicolumn completo:**

Maximum number of elements assembled at the factory (for transport and weight reasons): (Minimum length = 5 elements)

Overall Height mm	Number of elements <b>zehnder multicolumn completo</b>				
	C 2-column	C 3-column	C 4-column	C 5-column	C 6-column
300– 900	64	64	64	55	46
1000-3000	23	23	23	17	14

**Overall lengths of zehnder multicolumn klinik:**

Maximum number of elements assembled at the factory (for transport and weight reasons): (Minimum length = 5 elements)

Overall Height mm	Number of elements <b>zehnder multicolumn klinik</b>				
	K 2-column	K 3-column	K 4-column	K 5-column	K 6-column
190– 900	44	44	44	35	30
1000-3000	14	14	14	12	10

The maximum factory assembled radiator weight = 150 kg

Table for overall radiator tube lengths for 1–100 elements, see page 18

Technical data



**zehnder** multicolumn, multicolumn completto

**zehnder** multicolumn

2-column

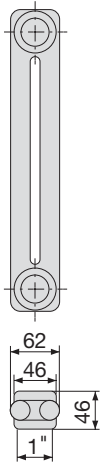

3-column

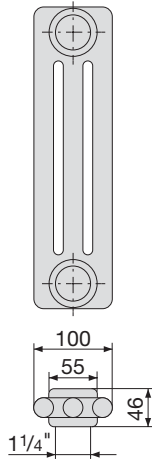

4-column

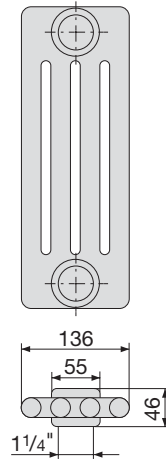

5-column

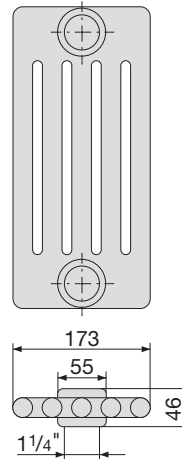

6-column

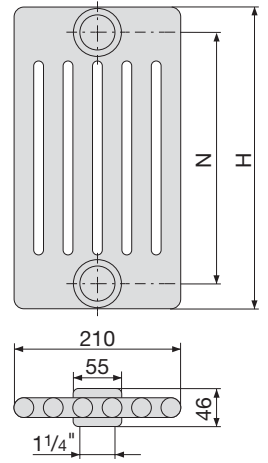

**zehnder** multicolumn completto

2-column

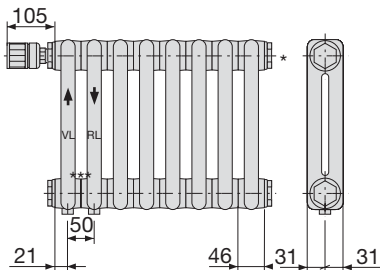

3-6 column

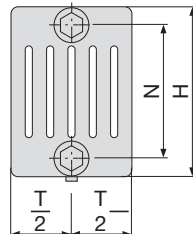

- H = overall height [mm]
- N = connection spacing [mm]
- A = surface area per section [m<sup>2</sup>]
- V = water content per section [dm<sup>3</sup>]
- M = dry weight per section [kg]
- s<sub>k</sub> = radiation percentage [%]
- q<sub>ms</sub> = standard water flow rate [kg/h]
- n = exponent
- VL = flow 1/2"
- RL = return 1/2"
- \* = air vent
- \*\*\* = baffle
- BL = No. of elements x 46
- overall width (mm)=(no. of sectionsx46)+30
- Note: TRV (M30x1.5) supplied as standard with multicolumn completto

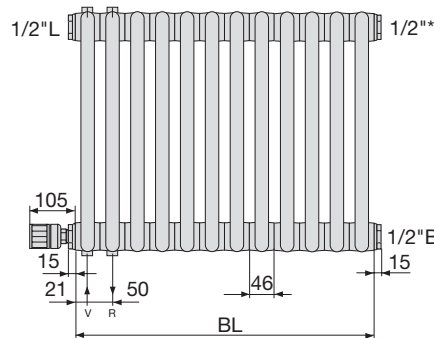
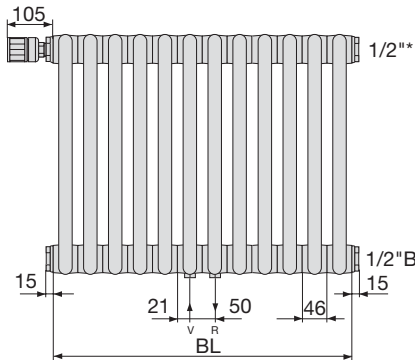

Please note: In the above model, the output in the first element is reduced due to the circulation pattern

Technical data

**zehnder** *multicolumn, multicolumn completo*



Technical data per section

Model	H mm	N mm	A m <sup>2</sup>	V dm <sup>3</sup> = Litre	M kg	S <sub>k</sub> %	q <sub>ms</sub> kg/h	Exp. n	Φ <sub>L</sub> =ΔT 50 K EN 442 Watt
2019	177	119	0.02	0.3	0.3	30	1	1.26	14.5
2026	260	202	0.04	0.3	0.4	25	2	1.25	21.1
2030	292	234	0.04	0.4	0.5	25	2	1.24	23.6
2035	342	284	0.05	0.4	0.6	24	2	1.24	27.5
2040	392	334	0.06	0.4	0.6	25	3	1.24	31.2
2045	442	384	0.07	0.5	0.7	24	3	1.24	34.9
2050	492	434	0.07	0.5	0.8	23	3	1.25	38.4
2055	542	484	0.08	0.6	0.9	23	4	1.25	41.9
2060	592	534	0.09	0.6	1.0	23	4	1.25	45.3
2075	742	684	0.11	0.7	1.2	22	5	1.25	55.0
2090	892	834	0.14	0.8	1.4	22	5	1.25	63.9
2100	992	934	0.15	0.9	1.6	22	6	1.25	69.5
2110	1092	1034	0.17	1.0	1.8	22	6	1.25	74.7
2120	1192	1134	0.18	1.1	1.9	22	7	1.26	82.7
2150	1492	1434	0.23	1.3	2.3	23	9	1.28	104.0
2180	1792	1734	0.28	1.5	2.7	23	11	1.31	124.0
2200	1992	1934	0.31	1.7	3.0	23	12	1.31	138.0
2220	2192	2134	0.34	1.9	3.3	23	13	1.31	151.0
2250	2492	2434	0.39	2.1	3.7	23	15	1.30	171.0
2280	2792	2734	0.44	2.4	4.1	23	16	1.30	189.0
2300	2992	2934	0.47	2.5	4.4	23	17	1.30	201.0
3019	185	119	0.04	0.4	0.5	23	2	1.27	20.1
3026	260	194	0.06	0.5	0.6	21	2	1.25	27.9
3030	300	234	0.07	0.6	0.7	20	3	1.25	32.0
3035	350	284	0.08	0.6	0.9	20	3	1.25	37.0
3040	400	334	0.09	0.7	1.0	19	4	1.25	41.9
3045	450	384	0.10	0.7	1.1	19	4	1.25	46.8
3050	500	434	0.11	0.8	1.2	18	4	1.25	51.6
3055	550	484	0.12	0.9	1.3	18	5	1.26	56.3
3060	600	534	0.14	0.9	1.4	18	5	1.26	60.9
3075	750	684	0.17	1.1	1.7	18	6	1.26	74.3
3090	900	834	0.21	1.3	2.1	18	7	1.27	87.0
3100	1000	934	0.23	1.4	2.3	18	8	1.27	95.1
3110	1100	1034	0.25	1.5	2.5	18	9	1.28	103.0
3120	1200	1134	0.28	1.6	2.8	18	10	1.29	115.0
3150	1500	1434	0.35	2.0	3.4	18	12	1.31	140.0
3180	1800	1734	0.42	2.4	4.1	18	14	1.33	166.0
3200	2000	1934	0.47	2.6	4.5	18	16	1.33	183.0
3220	2200	2134	0.51	2.9	4.9	18	17	1.32	200.0
3250	2500	2434	0.58	3.2	5.5	18	19	1.32	225.0
3280	2800	2734	0.65	3.6	6.1	18	22	1.30	251.0
3300	3000	2934	0.70	3.9	6.4	18	23	1.30	269.0
4019	200	134	0.06	0.6	0.8	20	2	1.26	28.4
4026	260	194	0.08	0.7	0.9	18	3	1.25	36.5
4030	300	234	0.09	0.7	1.0	18	4	1.25	41.9
4035	350	284	0.11	0.8	1.2	17	4	1.25	48.5
4040	400	334	0.12	0.9	1.4	16	5	1.26	54.9
4045	450	384	0.14	1.0	1.5	16	5	1.26	61.3
4050	500	434	0.15	1.0	1.7	16	6	1.26	67.6
4055	550	484	0.17	1.1	1.9	16	6	1.26	73.7
4060	600	534	0.19	1.2	2.0	15	7	1.27	79.8
4075	750	684	0.23	1.4	2.5	15	8	1.27	97.4
4090	900	834	0.28	1.7	2.9	15	10	1.28	114.0
4100	1000	934	0.31	1.8	3.2	15	11	1.29	125.0
4110	1100	1034	0.34	2.0	3.4	15	12	1.29	135.0
4120	1200	1134	0.37	2.1	3.7	15	13	1.30	147.0
4150	1500	1434	0.47	2.6	4.4	15	15	1.31	180.0
4180	1800	1734	0.56	3.1	5.2	15	18	1.33	213.0
4200	2000	1934	0.63	3.4	5.8	15	20	1.32	234.0
4220	2200	2134	0.69	3.8	6.4	15	22	1.32	256.0
4250	2500	2434	0.78	4.3	7.4	15	25	1.31	289.0
4280	2800	2734	0.88	4.8	8.3	15	28	1.30	323.0
4300	3000	2934	0.94	5.1	8.9	15	30	1.30	345.0

Technical data



**zehnder** *multicolumn, multicolumn completto*

Technical data per section

Model	H mm	N mm	A m <sup>2</sup>	V dm <sup>3</sup> = Litre	M kg	S <sub>k</sub> %	q <sub>ms</sub> kg/h	Exp. n	Φ <sub>L</sub> =ΔT 50 K EN 442 Watt
5019	200	134	0.08	0.7	0.9	19	3	1.25	35.0
5026	260	194	0.1	0.8	1.2	17	4	1.25	45.1
5030	300	234	0.12	0.9	1.3	16	4	1.25	51.7
5035	350	284	0.13	1.0	1.5	15	5	1.26	59.9
5040	400	334	0.15	1.1	1.7	15	6	1.26	67.9
5045	450	384	0.17	1.2	1.9	14	7	1.26	75.8
5050	500	434	0.19	1.3	2.1	14	7	1.27	83.5
5055	550	484	0.21	1.4	2.3	14	8	1.27	91.1
5060	600	534	0.23	1.5	2.5	13	8	1.27	98.6
5075	750	684	0.29	1.8	3.1	13	10	1.29	120.0
5090	900	834	0.35	2.1	3.6	13	12	1.30	141.0
5100	1000	934	0.39	2.3	3.9	13	13	1.30	154.0
5110	1100	1034	0.43	2.5	4.3	13	14	1.31	167.0
5120	1200	1134	0.47	2.7	4.6	13	15	1.31	179.0
5150	1500	1434	0.59	3.3	5.6	13	19	1.32	219.0
5180	1800	1734	0.70	3.9	6.6	13	22	1.32	259.0
5200	2000	1934	0.78	4.3	7.3	13	25	1.32	285.0
5220	2200	2134	0.86	4.7	8.1	13	27	1.32	312.0
5250	2500	2434	0.98	5.3	9.3	13	30	1.31	352.0
5280	2800	2734	1.10	5.9	10.5	13	34	1.30	392.0
5300	3000	2934	1.18	6.4	11.3	13	36	1.30	420.0
6019	200	134	0.09	0.8	1.1	19	4	1.27	41.5
6026	260	194	0.12	1.0	1.4	18	5	1.27	53.5
6030	300	234	0.14	1.1	1.6	15	5	1.26	61.3
6035	350	284	0.16	1.2	1.8	14	6	1.26	71.0
6040	400	334	0.19	1.3	2.0	14	7	1.27	80.5
6045	450	384	0.21	1.4	2.2	13	8	1.27	89.8
6050	500	434	0.23	1.5	2.4	13	9	1.28	99.0
6055	550	484	0.26	1.6	2.7	12	9	1.28	108.0
6060	600	534	0.28	1.8	2.9	12	10	1.29	117.0
6075	750	684	0.35	2.1	3.5	12	12	1.30	143.0
6090	900	834	0.42	2.5	4.2	12	14	1.31	167.0
6100	1000	934	0.47	2.7	4.6	12	16	1.31	183.0
6110	1100	1034	0.52	3.0	5.1	12	17	1.32	198.0
6120	1200	1134	0.56	3.2	5.5	12	18	1.32	210.0
6150	1500	1434	0.70	4.0	6.8	12	22	1.32	256.0
6180	1800	1734	0.85	4.7	8.2	12	26	1.33	303.0
6200	2000	1934	0.94	5.2	9.1	12	29	1.32	334.0
6220	2200	2134	1.03	5.6	10.0	12	31	1.32	365.0
6250	2500	2434	1.18	6.3	11.3	12	35	1.32	412.0
6280	2800	2734	1.33	7.0	12.7	12	39	1.30	459.0
6300	3000	2934	1.41	7.5	13.6	12	42	1.30	491.0

Technical data

**zehnder** *multicolumn klinik*



**zehnder** *multicolumn klinik* version

**K 2-column**

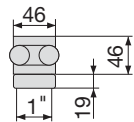
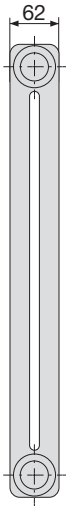

**K 3-column**

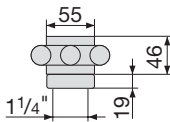

**K 4-column**

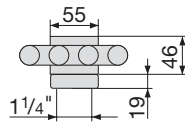
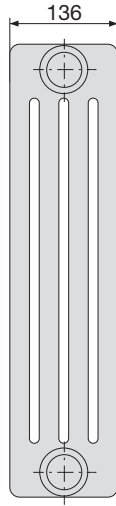

**K 5-column**

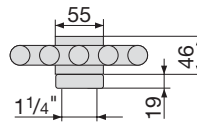
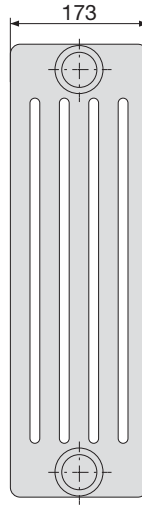

**K 6-column**

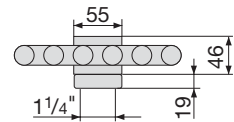
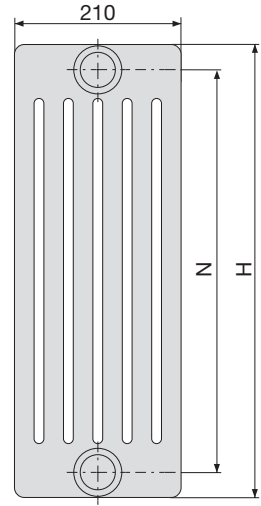

- H = overall height [mm]
- N = connection spacing [mm]
- A = surface area per section [m<sup>2</sup>]
- V = water content per section [dm<sup>3</sup>]
- M = dry weight per section [kg]
- s<sub>k</sub> = radiation percentage [%]
- q<sub>ms</sub> = standard water flow rate [kg/h]
- n = exponent

Technical data



**zehnder** *multicolumn klinik*

Technical data per section

Model	H mm	N mm	A m <sup>2</sup>	V dm <sup>3</sup> = Litre	M kg	S <sub>k</sub> %	q <sub>ms</sub> kg/h	Exp. n	Φ <sub>L</sub> =ΔT 50 K EN 442 Watt
K2019	177	119	0.03	0.3	0.4	30	1	1.30	17.2
K2026	260	202	0.04	0.4	0.5	25	2	1.30	23.9
K2030	292	234	0.05	0.4	0.6	25	2	1.29	26.5
K2035	342	284	0.06	0.4	0.7	24	3	1.29	29.3
K2040	392	334	0.07	0.5	0.7	25	3	1.29	32.3
K2045	442	384	0.07	0.5	0.8	24	3	1.29	35.4
K2050	492	434	0.08	0.6	0.9	23	3	1.29	38.6
K2055	542	484	0.09	0.6	1.0	23	4	1.29	41.9
K2060	592	534	0.10	0.6	1.1	23	4	1.29	45.2
K2075	742	684	0.12	0.8	1.3	22	5	1.29	55.8
K3019	185	119	0.05	0.5	0.6	23	2	1.26	23.5
K3026	260	194	0.06	0.6	0.7	21	3	1.27	31.6
K3030	300	234	0.07	0.6	0.8	20	3	1.27	35.9
K3035	350	284	0.08	0.7	1.0	20	4	1.28	41.1
K3040	400	334	0.10	0.7	1.1	19	4	1.28	46.3
K3045	450	384	0.11	0.8	1.2	19	4	1.28	51.3
K3050	500	434	0.12	0.9	1.3	18	5	1.28	56.3
K3055	550	484	0.13	0.9	1.4	18	5	1.29	61.3
K3060	600	534	0.14	1.0	1.5	18	6	1.29	66.2
K3075	750	684	0.18	1.2	1.9	18	7	1.30	80.7
K4019	200	134	0.07	0.6	0.9	20	3	1.26	31.7
K4026	260	194	0.09	0.7	1.0	18	3	1.26	40.0
K4030	300	234	0.10	0.8	1.1	18	4	1.26	45.5
K4035	350	284	0.11	0.9	1.3	17	4	1.26	52.3
K4040	400	334	0.13	0.9	1.4	16	5	1.27	59.1
K4045	450	384	0.15	1.0	1.6	16	6	1.27	65.8
K4050	500	434	0.16	1.1	1.7	16	6	1.27	72.5
K4055	550	484	0.18	1.2	1.9	16	7	1.28	79.2
K4060	600	534	0.19	1.3	2.0	15	7	1.28	85.8
K4075	750	684	0.24	1.5	2.5	15	9	1.29	106.0
K5019	200	134	0.08	0.8	1.0	19	3	1.26	38.8
K5026	260	194	0.11	0.9	1.3	17	4	1.25	48.9
K5030	300	234	0.12	1.0	1.4	16	5	1.25	55.7
K5035	350	284	0.14	1.1	1.6	15	6	1.25	64.0
K5040	400	334	0.16	1.2	1.8	15	6	1.26	72.4
K5045	450	384	0.18	1.3	2.0	14	7	1.26	80.7
K5050	500	434	0.20	1.4	2.2	14	8	1.26	89.0
K5055	550	484	0.22	1.5	2.3	14	8	1.27	97.3
K5060	600	534	0.24	1.6	2.5	13	9	1.27	106.0
K5075	750	684	0.30	1.9	3.1	13	11	1.28	130.0
K6019	200	134	0.10	0.9	1.2	19	4	1.27	45.8
K6026	260	194	0.13	1.0	1.5	18	5	1.28	58.1
K6030	300	234	0.15	1.1	1.7	15	6	1.29	66.2
K6035	350	284	0.17	1.3	1.9	14	7	1.29	76.2
K6040	400	334	0.19	1.4	2.1	14	7	1.29	86.2
K6045	450	384	0.22	1.5	2.3	13	8	1.29	96.1
K6050	500	434	0.24	1.6	2.5	13	9	1.29	106.0
K6055	550	484	0.26	1.8	2.7	12	10	1.29	116.0
K6060	600	534	0.29	1.9	3.0	12	11	1.29	125.0
K6075	750	684	0.36	2.2	3.6	12	13	1.30	154.0

**Pressure loss**

**zehnder** *multicolumn, multicolumn completo, multicolumn klinik*



**Minimum water flow  $q_m$  min.**

The standard water flow  $q_{ms}$  per model is given in the technical data tables. With multicolumn radiators, the actual flow  $q_m$  as a % of the standard flow  $q_{ms}$  should not exceed 17%.

**Inlet and outlet resistance**

Z-value  $\zeta = 2,5$  per radiator with connection diameters between  $\frac{3}{8}$ " and 1" and with a water speed of up to 1m/sec.

**Pressure drop  $\Delta p$**

The drop in pressure  $\Delta p$  per radiator, including ventilation, can be read from the following diagrams:

**zehnder**  
*multicolumn, multicolumn klinik:*  
**2-6 column with same-side or opposite-side connection**

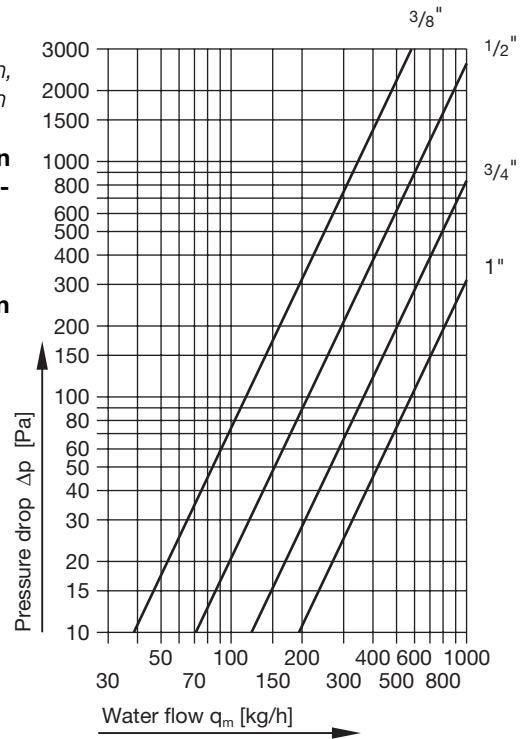

**zehnder** *multicolumn completo*

With valve on setting 6 (fully open):

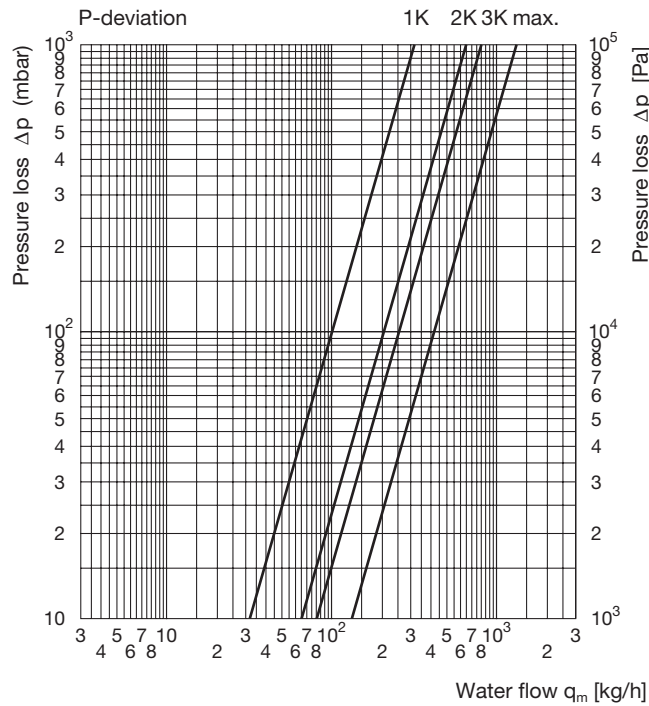

P-deviation of 2 K:

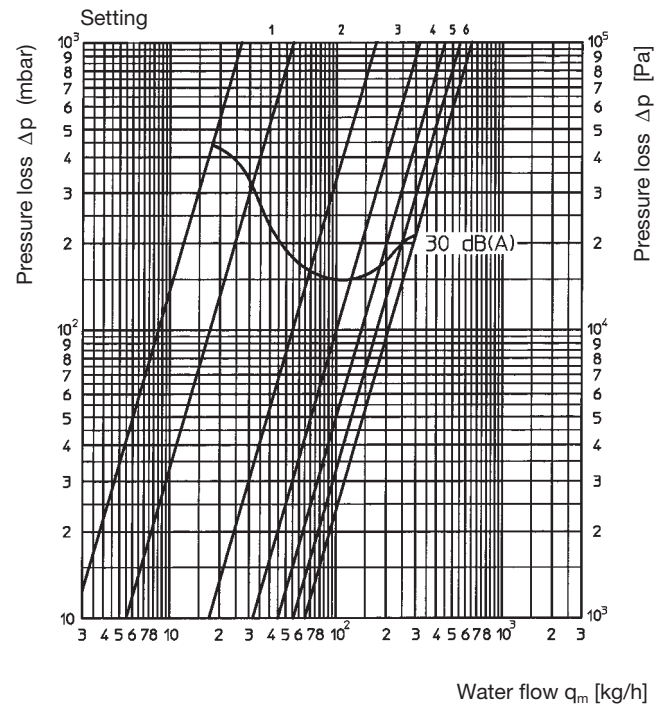

VE	1	2	3	4	5	6
Kv	0.055	0.170	0.313	0.446	0.56	0.65

Connection possibilities



**zehnder** *multicolumn, multicolumn klinik*

**Standard connection for single-entry systems**

Depending on the valve type, the functioning of single-entry connection radiators can only be guaranteed up to a certain length.

For additional information please contact the sales office technical department.

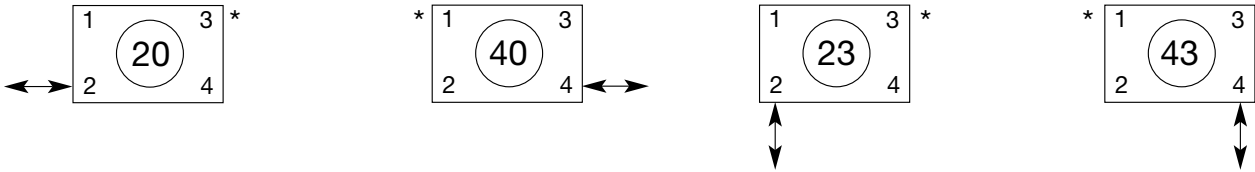

**Connections with two-pipe systems**

Standard connections 1/4", 3/8", 1/2", 3/4", 1" (1" only available for 3-6 column)

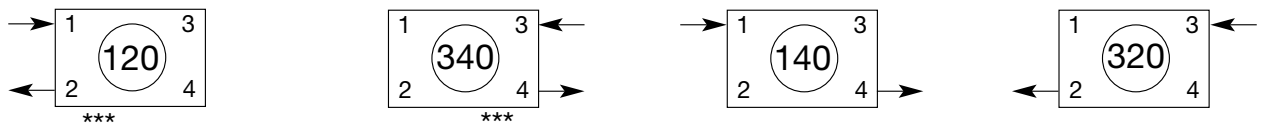

Special connections 1/4", 3/8", 1/2", 3/4" (price supplement)

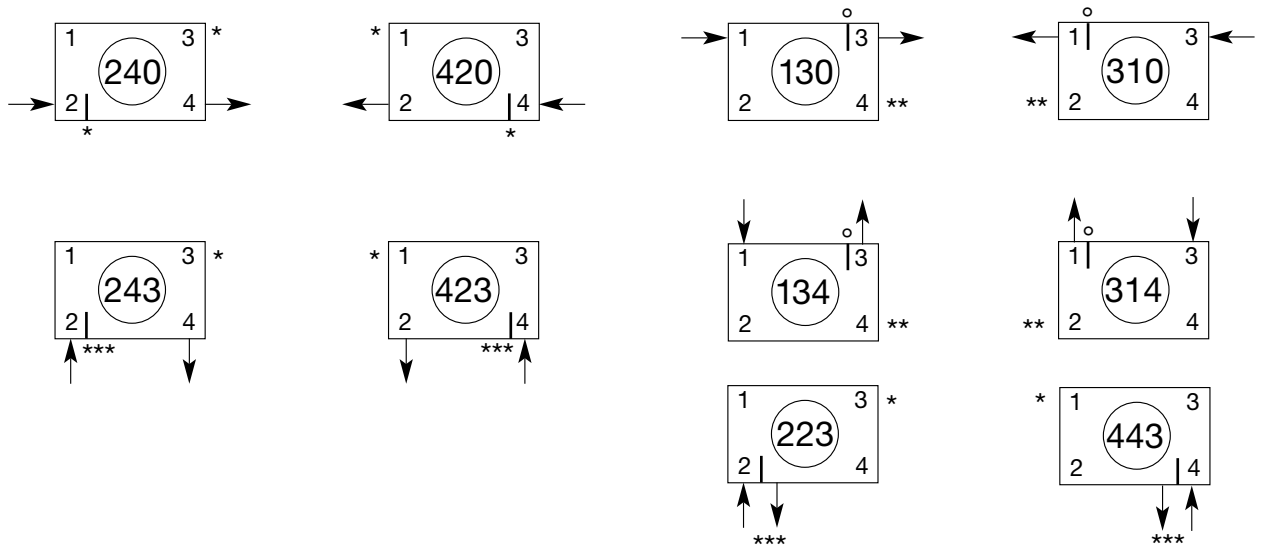

**Insert tubes**

When the radiator connections are on the same end, an inlet insert tube is installed on site over 2/3 of the overall length, to guarantee the rated heat emission if the following number of sections is exceeded.

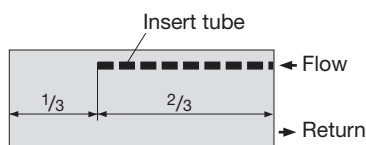

Model	Number of sections	Overall length mm	
		<i>multicolumn</i>	<i>multicolumn klinik</i>
2-column	87	4002	5636
3-column	85	3910	5506
4-column	81	3726	5246
5-column	71	3266	4596
6-column	55	2530	3556

- \* Ventilation obligatory
- \*\* Draining obligatory
- \*\*\* Baffle
- ° Baffle 100% watertight

Connection possibilities



**zehnder** multicolumn, multicolumn klinik

Connection types 243, 423

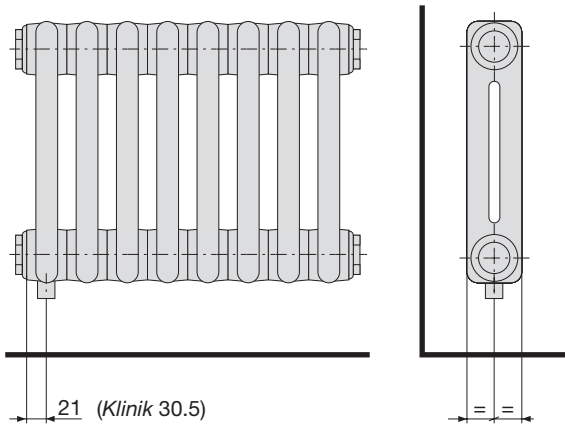

G = Standard connections 1/4", 3/8", 1/2", 3/4", 1"  
 (1" only for 3-6 column)  
 L<sub>2</sub> = Lengths of vertical connections  
 (3/8" + 1/2" = 6 mm, 3/4" = 15 mm,  
 turbulator = 19 mm)

All measurements in mm.

Connection types 223, 443

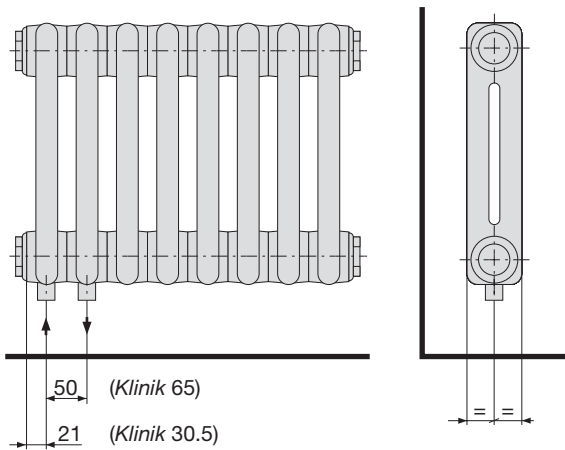

Connection types 23, 43

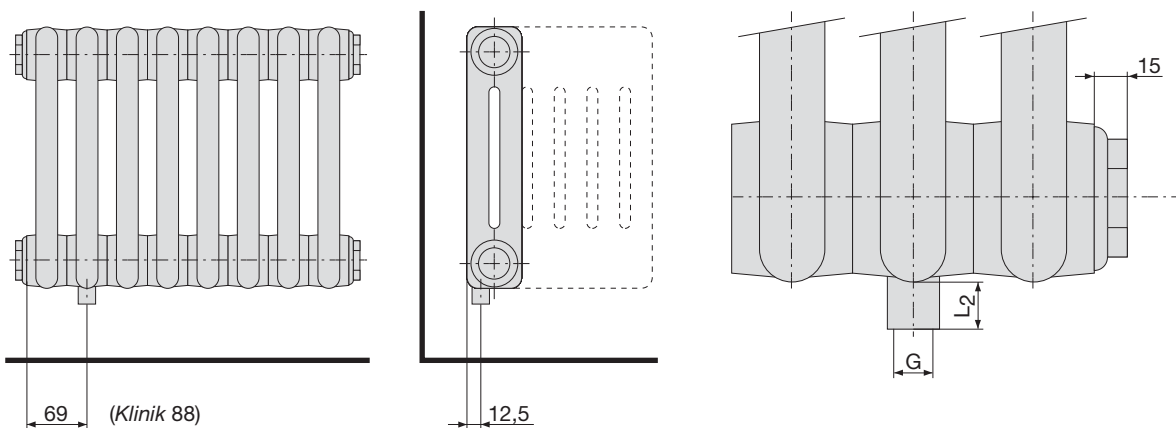

Couplings / Fixing provisions



**zehnder** *multicolumn*, *multicolumn klinik*

**Basic**

A series of coupled radiators can be considered technically as a single radiator.

The individual radiators of a series should not be located too far from each other and their coupling dimension should be one size greater than the connecting pipe. The recommended coupling dimension is 3/4".

**Connections at both ends**

Overall lengths and the number of radiators of the **zehnder** *multicolumn* and **zehnder** *multicolumn klinik* ranges are theoretically unlimited. Please note their transportation and weight restrictions.

**Same-end connection**

The maximum overall lengths of the **zehnder** *multicolumn* and *multicolumn klinik* depend on the overall height. Only two radiators should be connected together.

The maximum possible radiator length is limited:

Overall height mm	Number of sections	Overall length mm
200- 600	130	5980
750-1000	80	3680
1200 and above	30	1380

**Multicolumn radiators up to 1200 mm overall height**

The table applies to overall heights of up to 1200 mm and ordinary wall masonry. A double suspension system is recommended for greater overall heights.

Fixing provisions from to	2-4 columns Number of sections							5 and 6 columns Number of sections					
	23	24 41	42 58	59 76	77 93	94 100	94 110	23	24 41	42 58	59 76	77 93	94 100
Standard provision Top and bottom: Wall CVD brackets and BH clamps	4	6	8	10	12	14	14	6	8	10	12	14	16
Top and bottom: Masonry-anchored BKF brackets with securing device and BH clamps	4	6	8	10	12	14	14	6	8	10	12	14	16
Top: Masonry-anchored BKF brackets with Securing device and BH clamps	2	3	4	5	6	7	7	3	4	5	6	7	8
Bottom: Distance DS piece	2	3	3	4	4	4	4	3	5	5	8	10	10
Support foot up to 900 mm overall height	2	3	4	5	6	7	7	3	4	5	6	7	8

Example **zehnder** *multicolumn*

Radiator model 5200 (5 columns, 2000 mm overall height, 50 sections):

Top: 5 masonry-anchored BKF brackets with BSF 4 securing springs and BH clamps as supports

Bottom: 5 masonry-anchored BKF brackets with BH clamps

Example **zehnder** *multicolumn completto*

Radiator model C 5180 (5 columns, 1800 mm overall height, 50 sections):

Top: 5 masonry-anchored BKF brackets with BSF 4 securing springs and BH clamps as supports

Bottom: 5 masonry-anchored BKF brackets with BH clamps

Overall radiator lengths

**zehnder** *multicolumn, multicolumn completto, multicolumn klinik*



Number of sections	<i>multicolumn completto</i> L = mm	<i>Klinik</i> L = mm	Number of sections	<i>multicolumn completto</i> L = mm	<i>Klinik</i> L = mm
1	46	46	51	2346	3296
2	92	111	52	2392	3361
3	138	176	53	2438	3426
4	184	241	54	2484	3491
5	230	306	55	2530	3556
6	276	371	56	2576	3621
7	322	436	57	2622	3686
8	368	501	58	2668	3751
9	414	566	59	2714	3816
10	460	631	60	2760	3881
11	506	696	61	2806	3946
12	552	761	62	2852	4011
13	598	826	63	2898	4076
14	644	891	64	2944	4141
15	690	956	65	2990	4206
16	736	1021	66	3036	4271
17	782	1086	67	3082	4336
18	828	1151	68	3128	4401
19	874	1216	69	3174	4466
20	920	1281	70	3220	4531
21	966	1346	71	3266	4596
22	1012	1411	72	3312	4661
23	1058	1476	73	3358	4726
24	1104	1541	74	3404	4791
25	1150	1606	75	3450	4856
26	1196	1671	76	3496	4921
27	1242	1736	77	3542	4986
28	1288	1801	78	3588	5051
29	1334	1866	79	3634	5116
30	1380	1931	80	3680	5181
31	1426	1996	81	3726	5246
32	1472	2061	82	3772	5311
33	1518	2126	83	3818	5376
34	1564	2191	84	3864	5441
35	1610	2256	85	3910	5506
36	1656	2321	86	3956	5571
37	1702	2386	87	4002	5636
38	1748	2451	88	4048	5701
39	1794	2516	89	4094	5766
40	1840	2581	90	4140	5831
41	1886	2646	91	4186	5896
42	1932	2711	92	4232	5961
43	1978	2776	93	4278	6026
44	2024	2841	94	4324	6091
45	2070	2906	95	4370	6156
46	2116	2971	96	4416	6221
47	2162	3036	97	4462	6286
48	2208	3101	98	4508	6351
49	2254	3166	99	4554	6416
50	2300	3231	100	4600	6481

These measurements do not include the excess of either the connection stoppers or sleeves

Fixing provisions



# Radiator supports, wall brackets, wall spacers

## Dimensions from wall

Number of columns	Wall to centre of connections		Wall to front face of radiator
	Using 10 mm bracket slot	Using 15 mm bracket slot	
2	54	59	85 or 90
3	73	78	123 or 128
4	91	96	159 or 164
5	109	114	195 or 200
6	128	133	233 or 238

All sizes (approximate) in mm

Distance between Lateral connections: (no. of sections x46) +30 (plus valves)

### For 2–6 column radiators

#### BH/BHK clamp bracket

**Utilisation:** For 2–6 column radiators

**Finish:** RAL 9016

Type	Utilisation	RAL 9016	Special finish	Zinc
		Article No.	Article No.	Article No.
BH	<i>zehnder charleston</i>	774001	774009	774002
BHK	<i>zehnder completto</i> <i>zehnder klinik</i>	775011	775019	775012

BH



BHK

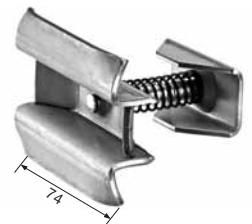

#### Standard Bracket Issue:

The **zehnder multicolumn** is supplied as standard with BH clamps and CVD-0 brackets.



#### CVD wall brackets

**Utilisation:** Screw on wall support with synthetic anti-friction/noise inserts, for use with BH/BHK bracket clamps

**Finish:** RAL 9016

Type	Distance/wall mm	RAL 9016	Special finish	Zinc
		Article No.	Article No.	Article No.
CVD-0	10/15	795001	795009	795002

CVD-0

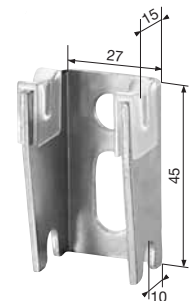

#### Distance pieces

**Utilisation:** For **zehnder multicolumn** and **zehnder multicolumn**

**Finish:** Synthetic

Type	Article No.
DS	780000

DS



Fixing provisions



**zehnder** *multicolumn, multicolumn completo, multicolumn klinik*



**Round tubular leg for 2-6 column radiators**

**Application:** This support leg is suitable for the freestanding installation of radiators with total heights of up to 1000 mm (radiator + support leg)  
For radiators above 600mm high, wall supports should be used in addition to the floor supports.

Description	Foot height mm	Order code n°
<b>Round tubular leg Welded to radiator, adjustable</b>	120 - 170	11000 13810
	170 - 350	11000 13870

Suitable for mounting on a finished or unfinished floor



**Base cover plate for unfinished floor**

Diameter of plate: 106mm  
Diameter of centre hole 25mm



**Cover plate for use with finished floors**

Diameter of plate: 48mm  
Diameter of centre hole 25mm

Cover plates exclude fixing screws etc.



**Welded foot**

Description	Foot height mm	Order code n°
<b>Welded foot with facility to screw to floor</b>	100	Field 9 = 8

**Additional top fixing is recommended to provide sufficient stability**

Fixing provisions

**zehnder**

## Security clips, floor supports for rapid installation, build-in wall supports

For radiators with 2–6 columns



### BFS security clips

**Utilisation:** **zehnder multicolumn**, **zehnder multicolumn completo**,  
**zehnder multicolumn klinik**  
For use with BKF build-in brackets and BH and BHK bracket clamps

**Finish:** Steel

Type	Article No.
BFS-4	777000



### Wall support for rapid installation

**Utilisation:** For quick, secure and simple installation of 2–6 columns  
**zehnder multicolumn** (not suitable for the **zehnder multicolumn klinik**)

**Finish:** White

Type	Height of <b>zehnder multicolumn</b> from	to	Height mm	Article No.
SSK 1	300	425	280	172011
SSK 2	430	545	430	172021
SSK 3	550	670	530	172031
SSK 4	730	870	730	172041
SSK 5	880	1000	880	172051
SSK 6	1000	3000	280 plus additional top support	172091

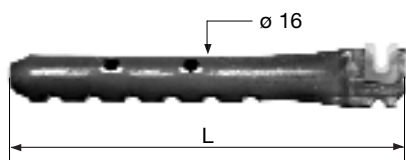

### Build-in brackets type BKF

**Utilisation:** For all radiators with fixed bracket positions

**Finish:** Zinc coated steel with synthetic anti-friction/noise inserts

Type	Ø mm	Length mm	Ø H mm	Ø W mm	Article No.
BKF 100	16.5	100	16	14	768002
BKF 115	16.5	115	16	14	768012
BKF 150	16.5	150	16	14	768022
BKF 175	16.5	175	16	14	768032
BKF 195	16.5	195	16	14	768042
BKF 250	16.5	250	17	15	768052
BKF 300	16.5	300	17	15	768062
BKF 350	16.5	350	17	15	768072

Diameter of inserted section:

H = for concrete etc.

W = for plaster, plasterboard, brick etc.

Special versions

**zehnder** *multicolumn, multicolumn klinik*



90° Angled version

	2-column	3-column	4-column	5-column	6-column
Standard internal angles	 106 Nr. 0-87	 143 Nr. 0-89	 180 Nr. 0-92	 216 Nr. 0-96	 254 Nr. 0-100
Standard external angles	 132 Nr. 0-88	 170 Nr. 0-90	 206 Nr. 0-93	 245 Nr. 0-97	 280 Nr. 0-101
Internal angles and special external angles		 158 Nr. 0-91	 180 Nr. 0-94	 216 Nr. 0-98	 254 Nr. 0-102
Special external angles			 206 Nr. 0-95	 260 Nr. 0-99	 280 Nr. 0-104
Special internal angles				 270 Nr. 0-189	 310 Nr. 0-103

Special configurations



**zehnder** *multicolumn, multicolumn completto, multicolumn klinik*

**Angled configuration**

Radiators with several angles can be supplied (3 or 4 angles max). depending on overall length & degree of angles.

Please supply dimensioned drawing with order

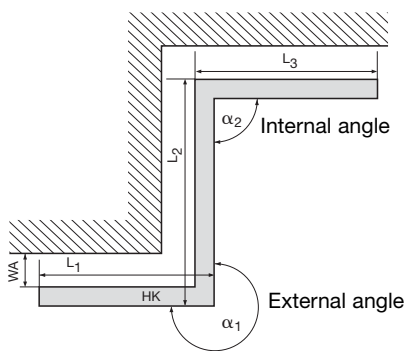
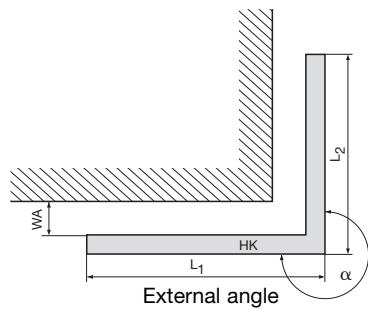
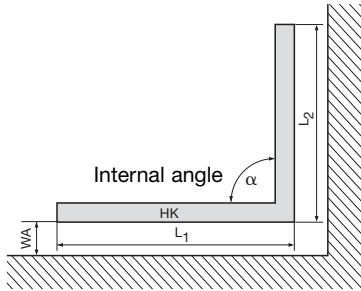

**Curved configuration**

Radius R must not be less than:

**zehnder multicolumn** and **zehnder multicolumn completto**

2-column = 400 mm

3-column = 650 mm

4-column = 750 mm

5-column = 900 mm

6-column = 1000 mm

**zehnder multicolumn klinik**

K 2-column = 800 mm

K 3-column = 1300 mm

K 4-column = 1500 mm

K 5-column = 1800 mm

K 6-column = 2000 mm

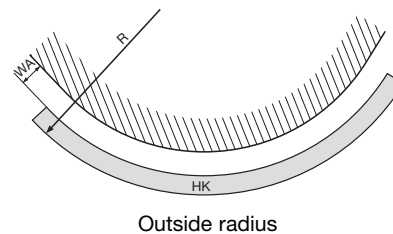
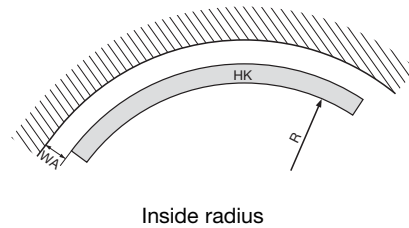

**Special configurations upon request. Important: please remember transport and installation requirements!**

- HK = Radiator
- WA = Distance from wall [mm]
- R = Wall radius [mm]
- alpha = Angle [°]
- L1, L2, L3 = Lengths [mm]

Heat capacity/technical data per section

**zehnder** multicolumn, multicolumn complete



Overall height = 177-260 mm

$\Phi_L = \Delta T$  50 K EN 442 (SN 384.501-503)

Mod.	2019			3019			4019			5019			6019			2026			3026			4026			5026			6026					
	T mm	H mm	Exp. n	T mm	H mm	Exp. n	T mm	H mm	Exp. n	T mm	H mm	Exp. n	T mm	H mm	Exp. n	T mm	H mm	Exp. n	T mm	H mm	Exp. n	T mm	H mm	Exp. n	T mm	H mm	Exp. n						
Sections	Watt 50	Watt 56	Watt 60	Watt 50	Watt 56	Watt 60	Watt 50	Watt 56	Watt 60	Watt 50	Watt 56	Watt 60	Watt 50	Watt 56	Watt 60	Watt 50	Watt 56	Watt 60	Watt 50	Watt 56	Watt 60	Watt 50	Watt 56	Watt 60	Watt 50	Watt 56	Watt 60	Watt 50	Watt 56	Watt 60	Watt 50	Watt 56	Watt 60
4	58	67	73	80	93	101	114	131	143	140	161	176	166	192	209	84	97	106	112	129	140	146	168	183	180	208	227	214	247	270			
5	73	84	91	101	116	127	142	164	179	175	202	220	208	240	262	106	122	133	140	161	175	183	210	229	226	260	283	268	309	337			
6	87	100	109	121	139	152	170	197	214	210	242	264	249	288	314	127	146	159	167	193	210	219	252	275	271	312	340	321	371	405			
7	102	117	128	141	162	177	199	229	250	245	282	308	291	335	366	148	170	186	195	225	245	256	294	321	316	364	397	375	432	472			
8	116	134	146	161	186	203	227	262	286	280	323	352	332	383	419	169	194	212	223	257	280	292	336	367	361	416	453	428	494	540			
9	131	151	164	181	209	228	256	295	322	315	363	396	374	431	471	190	219	239	251	289	315	329	378	413	406	468	510	482	556	607			
10	145	167	182	201	232	253	284	328	357	350	403	440	415	479	523	211	243	265	279	321	350	365	421	458	451	520	566	535	618	674			
11	160	184	201	221	255	279	312	360	393	385	444	484	457	527	575	232	267	292	307	354	385	402	463	504	496	572	623	589	680	742			
12	174	201	219	241	279	304	341	393	429	420	484	528	498	575	628	253	292	318	335	386	420	438	505	550	541	624	680	642	741	809			
13	189	217	237	261	302	329	369	426	465	455	524	571	540	623	680	274	316	345	363	418	456	475	547	596	586	676	736	696	803	877			
14	203	234	255	281	325	355	398	459	500	490	565	615	581	671	732	295	340	371	391	450	491	511	589	642	631	727	793	749	865	944			
15	218	251	274	302	348	380	426	491	536	525	605	659	623	719	785	317	365	398	419	482	526	548	631	688	677	779	850	803	927	1012			
16	232	268	292	322	371	405	454	524	572	560	645	703	664	767	837	338	389	424	446	514	561	584	673	733	722	831	906	856	989	1079			
17	247	284	310	342	395	431	483	557	607	595	686	747	706	815	889	359	413	451	474	546	596	621	715	779	767	883	963	910	1050	1146			
18	261	301	328	362	418	456	511	590	643	630	726	791	747	863	942	380	438	477	502	579	631	657	757	825	812	935	1020	963	1112	1214			
19	276	318	347	382	441	481	540	622	679	665	766	835	789	911	994	401	462	504	530	611	666	694	799	871	857	987	1076	1017	1174	1281			
20	290	335	365	402	464	507	568	655	715	700	807	879	830	958	1046	422	486	530	558	643	701	730	841	917	902	1039	1133	1070	1236	1349			
21	305	351	383	422	487	532	596	688	750	735	847	923	872	1006	1099	443	511	557	586	675	736	767	883	963	947	1091	1190	1124	1297	1416			
22	319	368	401	442	511	557	625	721	786	770	887	967	913	1054	1151	464	535	583	614	707	771	803	925	1009	992	1143	1246	1177	1359	1484			
23	334	385	420	462	534	583	653	753	822	805	928	1011	955	1102	1203	485	559	610	642	739	806	840	967	1054	1037	1195	1303	1231	1421	1551			
24	348	401	438	482	557	608	682	786	858	840	968	1055	996	1150	1256	506	583	636	670	772	841	876	1009	1100	1082	1247	1359	1284	1483	1619			
25	363	418	456	503	580	633	710	819	893	875	1008	1099	1038	1198	1308	528	608	663	698	804	876	913	1051	1146	1128	1299	1416	1338	1545	1686			
26	377	435	474	523	603	659	738	852	929	910	1048	1143	1079	1246	1360	549	632	689	725	836	911	949	1093	1192	1173	1351	1473	1391	1606	1753			
27	392	452	493	543	627	684	767	884	965	945	1089	1187	1121	1294	1412	570	656	716	753	868	946	986	1135	1238	1218	1403	1529	1445	1668	1821			
28	406	468	511	563	650	709	795	917	1001	980	1129	1231	1162	1342	1465	591	681	742	781	900	981	1022	1178	1284	1263	1455	1586	1498	1730	1888			
29	421	485	529	583	673	735	824	950	1036	1015	1169	1275	1204	1390	1517	612	705	769	809	932	1016	1059	1220	1329	1308	1507	1643	1552	1792	1956			
30	435	502	547	603	696	760	852	983	1072	1050	1210	1319	1245	1438	1569	633	729	795	837	964	1051	1095	1262	1375	1353	1559	1699	1605	1853	2023			
31	450	518	566	623	720	785	880	1016	1108	1085	1250	1363	1287	1486	1622	654	754	822	865	997	1086	1132	1304	1421	1398	1611	1756	1659	1915	2091			
32	464	535	584	643	743	811	909	1048	1144	1120	1290	1407	1328	1534	1674	675	778	848	893	1029	1121	1168	1346	1467	1443	1663	1813	1712	1977	2158			
33	479	552	602	663	766	836	937	1081	1179	1155	1331	1451	1370	1581	1726	696	802	875	921	1061	1156	1205	1388	1513	1488	1715	1869	1766	2039	2226			
34	493	569	620	683	789	861	966	1114	1215	1190	1371	1495	1411	1629	1779	717	827	901	949	1093	1191	1241	1430	1559	1533	1767	1926	1819	2101	2293			
35	508	585	639	704	812	887	994	1147	1251	1225	1411	1539	1453	1677	1831	739	851	928	977	1125	1226	1278	1472	1604	1579	1819	1983	1873	2162	2360			
36	522	602	657	724	836	912	1022	1179	1286	1260	1452	1583	1494	1725	1883	760	875	954	1004	1157	1261	1314	1514	1650	1624	1871	2039	1926	2224	2428			
37	537	619	675	744	859	937	1051	1212	1322	1295	1492	1626	1536	1773	1936	781	900	981	1032	1189	1297	1351	1556	1696	1669	1923	2096	1980	2286	2495			
38	551	636	693	764	882	963	1079	1245	1358	1330	1532	1670	1577	1821	1988	802	924	1007	1060	1222	1332	1387	1598	1742	1714	1975	2152	2033	2348	2563			
39	566	652	712	784	905	988	1108	1278	1394	1365	1573	1714	1619	1869	2040	823	948	1034	1088	1254	1367	1424	1640	1788	1759	2027	2209	2087	2409	2630			
40	580	669	730	804	928	1013	1136	1310	1429	1400	1613	1758	1660	1917	2093	844	972	1060	1116	1286	1402	1460	1682	1834	1804	2079	2266	2140	2471	2698			
41	595	686	748	824	952	1039	1164	1343	1465	1435	1653	1802	1702	1965	2145	865	997	1087	1144	1318	1437	1497	1724	1880	1849	2131	2322	2194	2533	2765			
42	609	702	766	844	975	1064	1193	1376	1501	1470	1694	1846	1743	2013	2197	886	1021	1113	1172	1350	1472	1533	1766	1925	1894	2182	2379	2247	2595	2832			
43	624	719	785	864	998	1089	1221	1409	1537	1505	1734	1890	1785	2061	2249	907	1045	1140	1200	1382	1507	1570	1808	1971	1939	2234	2436	2301	2657	2900			
44	638	736	803	884	1021	1115	1250	1441	1572	1540	1774	1934	1826	2109	2302	928	1070	1166	1228	1414	1542	1606	1850	2017	1984	2286	2492	2354	2718	2967			
45	653																																

Heat capacity/technical data per section



**zehnder** multicolumn, multicolumn completto

Overall height = 292–350 mm  $\Phi_L = \Delta T \text{ 50 K EN 442 (SN 384.501-503)}$

		2030			3030			4030			5030			6030			2035			3035			4035			5035			6035					
		50	56	60	50	56	60	50	56	60	50	56	60	50	56	60	50	56	60	50	56	60	50	56	60	50	56	60	50	56	60			
<b>Mod.</b>		2030			3030			4030			5030			6030			2035			3035			4035			5035			6035					
<b>T</b>	mm	62			100			136			173			210			62			100			136			173			210					
<b>H</b>	mm	292			300			300			300			300			342			350			350			350			350					
<b>Exp.</b>	n	1.24			1.25			1.25			1.25			1.26			1.24			1.25			1.25			1.26			1.26					
<b>Sections</b>		50	56	60	50	56	60	50	56	60	50	56	60	50	56	60	50	56	60	50	56	60	50	56	60	50	56	60	50	56	60	50	56	60
<b>4</b>		94	109	118	128	147	161	168	193	210	207	238	260	245	283	309	110	127	138	148	171	186	194	224	244	240	276	301	284	328	357			
<b>5</b>		118	136	148	160	184	201	210	241	263	259	298	325	307	354	386	138	158	172	185	213	232	243	279	305	300	345	377	355	409	447			
<b>6</b>		142	163	178	192	221	241	251	290	316	310	357	390	368	424	463	165	190	207	222	256	279	291	335	365	359	415	452	426	491	536			
<b>7</b>		165	190	207	224	258	281	293	338	368	362	417	455	429	495	540	193	222	241	259	298	325	340	391	426	419	484	528	497	573	625			
<b>8</b>		189	217	237	256	295	322	335	386	421	414	477	519	490	566	617	220	253	276	296	341	372	388	447	487	479	553	603	568	655	715			
<b>9</b>		212	244	266	288	332	362	377	434	474	465	536	584	552	636	694	248	285	310	333	384	418	437	503	548	539	622	678	639	737	804			
<b>10</b>		236	272	296	320	369	402	419	483	526	517	596	649	613	707	771	275	316	345	370	426	465	485	559	609	599	691	754	710	819	893			
<b>11</b>		260	299	325	352	406	442	461	531	579	569	655	714	674	778	848	303	348	379	407	469	511	534	615	670	659	760	829	781	901	983			
<b>12</b>		283	326	355	384	442	482	503	579	631	620	715	779	736	849	926	330	380	414	444	512	558	582	671	731	719	829	904	852	983	1072			
<b>13</b>		307	353	385	416	479	522	545	628	684	672	774	844	797	919	1003	358	411	448	481	554	604	631	726	792	779	898	980	923	1065	1161			
<b>14</b>		330	380	414	448	516	563	587	676	737	724	834	909	858	990	1080	385	443	483	518	597	651	679	782	853	839	967	1055	994	1147	1251			
<b>15</b>		354	407	444	480	553	603	629	724	789	776	894	974	920	1061	1157	413	475	517	555	639	697	728	838	914	899	1036	1131	1065	1228	1340			
<b>16</b>		378	435	473	512	590	643	670	772	842	827	953	1039	981	1131	1234	440	506	552	592	682	744	776	894	975	958	1106	1206	1136	1310	1429			
<b>17</b>		401	462	503	544	627	683	712	821	895	879	1013	1104	1042	1202	1311	468	538	586	629	725	790	825	950	1036	1018	1175	1281	1207	1392	1519			
<b>18</b>		425	489	533	576	664	723	754	869	947	931	1072	1169	1103	1273	1388	495	570	621	666	767	836	873	1006	1096	1078	1244	1357	1278	1474	1608			
<b>19</b>		448	516	562	608	701	764	796	917	1000	982	1132	1234	1165	1343	1465	523	601	655	703	810	883	922	1062	1157	1138	1313	1432	1349	1556	1697			
<b>20</b>		472	543	592	640	737	804	838	966	1052	1034	1191	1299	1226	1414	1543	550	633	690	740	853	929	970	1118	1218	1198	1382	1507	1420	1638	1787			
<b>21</b>		496	570	621	672	774	844	880	1014	1105	1086	1251	1364	1287	1485	1620	578	665	724	777	895	976	1019	1174	1279	1258	1451	1583	1491	1720	1876			
<b>22</b>		519	598	651	704	811	884	922	1062	1158	1137	1310	1429	1349	1556	1697	605	696	758	814	938	1022	1067	1229	1340	1318	1520	1658	1562	1802	1965			
<b>23</b>		543	625	680	736	848	924	964	1110	1210	1189	1370	1493	1410	1626	1774	633	728	793	851	981	1069	1116	1285	1401	1378	1589	1733	1633	1884	2055			
<b>24</b>		566	652	710	768	885	965	1006	1159	1263	1241	1430	1558	1471	1697	1851	660	760	827	888	1023	1115	1164	1341	1462	1438	1658	1809	1704	1966	2144			
<b>25</b>		590	679	740	800	922	1005	1048	1207	1316	1293	1489	1623	1533	1768	1928	688	791	862	925	1066	1162	1213	1397	1523	1498	1727	1884	1775	2047	2233			
<b>26</b>		614	706	769	832	959	1045	1089	1255	1368	1344	1549	1688	1594	1838	2005	715	823	896	962	1108	1208	1261	1453	1584	1557	1796	1960	1846	2129	2323			
<b>27</b>		637	733	799	864	995	1085	1131	1303	1421	1396	1608	1753	1655	1909	2083	743	855	931	999	1151	1255	1310	1509	1645	1617	1866	2035	1917	2211	2412			
<b>28</b>		661	761	828	896	1032	1125	1173	1352	1473	1448	1668	1818	1716	1980	2160	770	886	965	1036	1194	1301	1358	1565	1706	1677	1935	2110	1988	2293	2501			
<b>29</b>		684	788	858	928	1069	1166	1215	1400	1526	1499	1727	1883	1778	2051	2237	798	918	1000	1073	1236	1348	1407	1621	1767	1737	2004	2186	2059	2375	2591			
<b>30</b>		708	815	888	960	1106	1206	1257	1448	1579	1551	1787	1948	1839	2121	2314	825	949	1034	1110	1279	1394	1455	1676	1827	1797	2073	2261	2130	2457	2680			
<b>31</b>		732	842	917	992	1143	1246	1299	1497	1631	1603	1847	2013	1900	2192	2391	853	981	1069	1147	1322	1441	1504	1732	1888	1857	2142	2336	2201	2539	2769			
<b>32</b>		755	869	947	1024	1180	1286	1341	1545	1684	1654	1906	2078	1962	2263	2468	880	1013	1103	1184	1364	1487	1552	1788	1949	1917	2211	2412	2272	2621	2859			
<b>33</b>		779	896	976	1056	1217	1326	1383	1593	1737	1706	1966	2143	2023	2333	2545	908	1044	1138	1221	1407	1534	1601	1844	2010	1977	2280	2487	2343	2703	2948			
<b>34</b>		802	923	1006	1088	1254	1366	1425	1641	1789	1758	2025	2208	2084	2404	2622	935	1076	1172	1258	1449	1580	1649	1900	2071	2037	2349	2563	2414	2785	3037			
<b>35</b>		826	951	1036	1120	1290	1407	1467	1690	1842	1810	2085	2273	2146	2475	2700	963	1108	1207	1295	1492	1626	1698	1956	2132	2097	2418	2638	2485	2866	3127			
<b>36</b>		850	978	1065	1152	1327	1447	1508	1738	1894	1861	2144	2338	2207	2546	2777	990	1139	1241	1332	1535	1673	1746	2012	2193	2156	2487	2713	2556	2948	3216			
<b>37</b>		873	1005	1095	1184	1364	1487	1550	1786	1947	1913	2204	2403	2268	2616	2854	1018	1171	1276	1369	1577	1719	1795	2068	2254	2216	2556	2789	2627	3030	3305			
<b>38</b>		897	1032	1124	1216	1401	1527	1592	1835	2000	1965	2264	2467	2329	2687	2931	1045	1203	1310	1406	1620	1766	1843	2123	2315	2276	2626	2864	2698	3112	3395			
<b>39</b>		920	1059	1154	1248	1438	1567	1634	1883	2052	2016	2323	2532	2391	2758	3008	1073	1234	1345	1443	1663	1812	1892	2179	2376	2336	2695	2939	2769	3194	3484			
<b>40</b>		944	1086	1183	1280	1475	1608	1676	1931	2105	2068	2383	2597	2452	2828	3085	1100	1266	1379	1480	1705	1859	1940	2235	2437	2396	2764	3015	2840	3276	3573			
<b>41</b>		968	1114	1213	1312	1512	1648	1718	1979	2158	2120	2442	2662																					

Heat capacity/technical data per section

**zehnder** multicolumn, multicolumn completo



Overall height = 392–450 mm

$\Phi_L = \Delta T 50 K EN 442$  (SN 384.501-503)

Mod.	2040			3040			4040			5040			6040			2045			3045			4045			5045			6045					
	T mm	H mm	Exp. n	T mm	H mm	Exp. n	T mm	H mm	Exp. n	T mm	H mm	Exp. n	T mm	H mm	Exp. n	T mm	H mm	Exp. n	T mm	H mm	Exp. n	T mm	H mm	Exp. n	T mm	H mm	Exp. n	T mm	H mm	Exp. n			
Sections	Watt 50	Watt 56	Watt 60	Watt 50	Watt 56	Watt 60	Watt 50	Watt 56	Watt 60	Watt 50	Watt 56	Watt 60	Watt 50	Watt 56	Watt 60	Watt 50	Watt 56	Watt 60	Watt 50	Watt 56	Watt 60	Watt 50	Watt 56	Watt 60	Watt 50	Watt 56	Watt 60	Watt 50	Watt 56	Watt 60	Watt 50	Watt 56	Watt 60
4	125	144	156	168	193	210	220	253	276	272	313	342	322	372	406	140	161	175	187	216	235	245	283	309	303	350	382	359	415	453			
5	156	180	196	210	241	263	275	317	345	340	392	427	403	465	507	175	201	219	234	270	294	307	354	386	379	437	477	449	519	566			
6	187	215	235	251	290	316	329	380	414	407	470	513	483	558	609	209	241	263	281	324	353	368	424	463	455	525	572	539	622	679			
7	218	251	274	293	338	368	384	443	484	475	548	598	564	651	710	244	281	306	328	377	411	429	495	540	531	612	668	629	726	792			
8	250	287	313	335	386	421	439	507	553	543	627	683	644	744	812	279	321	350	374	431	470	490	566	617	606	699	763	718	830	906			
9	281	323	352	377	434	474	494	570	622	611	705	769	725	837	913	314	361	394	421	485	529	552	636	694	682	787	858	808	933	1019			
10	312	359	391	419	483	526	549	633	691	679	783	854	805	930	1015	349	402	438	468	539	588	613	707	771	758	874	954	898	1037	1132			
11	343	395	430	461	531	579	604	697	760	747	862	940	886	1023	1116	384	442	481	515	593	647	674	778	848	834	962	1049	988	1141	1245			
12	374	431	469	503	579	631	659	760	829	815	940	1025	966	1116	1218	419	482	525	562	647	705	736	849	926	910	1049	1145	1078	1244	1358			
13	406	467	508	545	628	684	714	823	898	883	1018	1111	1047	1208	1319	454	522	569	608	701	764	797	919	1003	985	1137	1240	1167	1348	1472			
14	437	503	548	587	676	737	769	887	967	951	1097	1196	1127	1301	1421	489	562	613	655	755	823	858	990	1080	1061	1224	1335	1257	1452	1585			
15	468	539	587	629	724	789	824	950	1036	1019	1175	1282	1208	1394	1522	524	602	656	702	809	882	920	1061	1157	1137	1312	1431	1347	1556	1698			
16	499	575	626	670	772	842	878	1013	1105	1086	1253	1367	1288	1487	1624	558	643	700	749	863	940	981	1131	1234	1213	1399	1526	1437	1659	1811			
17	530	610	665	712	821	895	933	1077	1174	1154	1331	1452	1369	1580	1725	593	683	744	796	917	999	1042	1202	1311	1289	1486	1621	1527	1763	1924			
18	562	646	704	754	869	947	988	1140	1243	1222	1410	1538	1449	1673	1827	628	723	788	842	971	1058	1103	1273	1388	1364	1574	1717	1616	1867	2038			
19	593	682	743	796	917	1000	1043	1203	1312	1290	1488	1623	1530	1766	1928	663	763	831	889	1025	1117	1165	1343	1465	1440	1661	1812	1706	1970	2151			
20	624	718	782	838	966	1052	1098	1267	1382	1358	1566	1709	1610	1859	2029	698	803	875	936	1078	1176	1226	1414	1543	1516	1749	1908	1796	2074	2264			
21	655	754	821	880	1014	1105	1153	1330	1451	1426	1645	1794	1691	1952	2131	733	843	919	983	1132	1234	1287	1485	1620	1592	1836	2003	1886	2178	2377			
22	686	790	861	922	1062	1158	1208	1393	1520	1494	1723	1880	1771	2045	2232	768	884	963	1030	1186	1293	1349	1556	1697	1668	1924	2098	1976	2281	2490			
23	718	826	900	964	1110	1210	1263	1457	1589	1562	1801	1965	1852	2138	2334	803	924	1006	1076	1240	1352	1410	1626	1774	1743	2011	2194	2065	2385	2604			
24	749	862	939	1006	1159	1263	1318	1520	1658	1630	1880	2050	1932	2231	2435	838	964	1050	1123	1294	1411	1471	1697	1851	1819	2098	2289	2155	2489	2717			
25	780	898	978	1048	1207	1316	1373	1583	1727	1698	1958	2136	2013	2324	2537	873	1004	1094	1170	1348	1469	1533	1768	1928	1895	2186	2384	2245	2593	2830			
26	811	934	1017	1089	1255	1368	1427	1646	1796	1765	2036	2221	2093	2417	2638	907	1044	1138	1217	1402	1528	1594	1838	2005	1971	2273	2480	2335	2696	2943			
27	842	970	1056	1131	1303	1421	1482	1710	1865	1833	2115	2307	2174	2510	2740	942	1084	1181	1264	1456	1587	1655	1909	2083	2047	2361	2575	2425	2800	3056			
28	874	1005	1095	1173	1352	1473	1537	1773	1934	1901	2193	2392	2254	2603	2841	977	1125	1225	1310	1510	1646	1716	1980	2160	2122	2448	2671	2514	2904	3170			
29	905	1041	1134	1215	1400	1526	1592	1836	2003	1969	2271	2478	2335	2696	2943	1012	1165	1269	1357	1564	1705	1778	2051	2237	2198	2536	2766	2604	3007	3283			
30	936	1077	1173	1257	1448	1579	1647	1900	2072	2037	2350	2563	2415	2789	3044	1047	1205	1313	1404	1618	1763	1839	2121	2314	2274	2623	2861	2694	3111	3396			
31	967	1113	1213	1299	1497	1631	1702	1963	2141	2105	2428	2648	2496	2882	3146	1082	1245	1356	1451	1672	1822	1900	2192	2391	2350	2710	2957	2784	3215	3509			
32	998	1149	1252	1341	1545	1684	1757	2026	2211	2173	2506	2734	2576	2975	3247	1117	1285	1400	1498	1726	1881	1962	2263	2468	2426	2798	3052	2874	3318	3622			
33	1030	1185	1291	1383	1593	1737	1812	2090	2280	2241	2585	2819	2657	3068	3349	1152	1325	1444	1544	1779	1940	2023	2333	2545	2501	2885	3147	2963	3422	3736			
34	1061	1221	1330	1425	1641	1789	1867	2153	2349	2309	2663	2905	2737	3161	3450	1187	1366	1488	1591	1833	1998	2084	2404	2622	2577	2973	3243	3053	3526	3849			
35	1092	1257	1369	1467	1690	1842	1922	2216	2418	2377	2741	2990	2818	3254	3552	1222	1406	1531	1638	1887	2057	2146	2475	2700	2653	3060	3338	3143	3630	3962			
36	1123	1293	1408	1508	1738	1894	1976	2280	2487	2444	2820	3076	2898	3347	3653	1256	1446	1575	1685	1941	2116	2207	2546	2777	2729	3148	3434	3233	3733	4075			
37	1154	1329	1447	1550	1786	1947	2031	2343	2556	2512	2898	3161	2979	3440	3755	1291	1486	1619	1732	1995	2175	2268	2616	2854	2805	3235	3529	3323	3837	4188			
38	1186	1364	1486	1592	1835	2000	2086	2406	2625	2580	2976	3247	3059	3533	3856	1326	1526	1663	1778	2049	2234	2329	2687	2931	2880	3323	3624	3412	3941	4302			
39	1217	1400	1525	1634	1883	2052	2141	2470	2694	2648	3055	3332	3140	3625	3957	1361	1566	1706	1825	2103	2292	2391	2758	3008	2956	3410	3720	3502	4044	4415			
40	1248	1436	1565	1676	1931	2105	2196	2533	2763	2716	3133	3417	3220	3718	4059	1396	1607	1750	1872	2157	2351	2452	2828	3085	3032	3497	3815	3592	4148	4528			
41	1279	1472	1604	1718	1979	2158	2251	2596	2832	2784	3211	3503	3301	3811	4160	1431	1647	1794	1919	2211	2410	2513	2899	3162	3108	3585	3910	3682	4252	4641			
42	1310	1508	1643	1760	2028	2210	2306	2660	2901	2852	3290	3588	3381	3904	4262	1466	1687	1838	1966	2265	2469	2575	2970	3240	3184	3672	4006	3772	4355	4754			
43	1342	1544	1682	1802	2076	2263	2361	2723	2970	2920	3368	3674	3462	3997	4363	1501	1727	1881	2012														



Heat capacity/technical data per section

**zehnder** multicolumn, multicolumn complete



Overall height = 592-750 mm

$\Phi_L = \Delta T$  50 K EN 442 (SN 384.501-503)

Mod.	2060			3060			4060			5060			6060			2075			3075			4075			5075			6075		
	T mm	H mm	Exp. n	T mm	H mm	Exp. n	T mm	H mm	Exp. n	T mm	H mm	Exp. n	T mm	H mm	Exp. n	T mm	H mm	Exp. n	T mm	H mm	Exp. n	T mm	H mm	Exp. n	T mm	H mm	Exp. n			
Sections	Watt 50	Watt 56	Watt 60	Watt 50	Watt 56	Watt 60	Watt 50	Watt 56	Watt 60	Watt 50	Watt 56	Watt 60	Watt 50	Watt 56	Watt 60	Watt 50	Watt 56	Watt 60	Watt 50	Watt 56	Watt 60	Watt 50	Watt 56	Watt 60	Watt 50	Watt 56	Watt 60	Watt 50	Watt 56	Watt 60
4	181	209	228	244	281	307	319	369	402	394	455	497	468	542	592	220	253	276	297	343	374	390	450	491	480	556	607	572	663	725
5	227	261	284	305	351	383	399	461	503	493	569	621	585	677	740	275	317	345	372	429	467	487	562	614	600	694	759	715	828	906
6	272	313	341	365	421	460	479	553	604	592	683	746	702	813	888	330	380	414	446	514	561	584	675	737	720	833	911	858	994	1087
7	317	365	398	426	492	536	559	645	704	690	797	870	819	948	1036	385	444	484	520	600	654	682	787	859	840	972	1063	1001	1160	1269
8	362	418	455	487	562	613	638	737	805	789	911	994	936	1083	1184	440	507	553	594	686	748	779	900	982	960	1111	1215	1144	1326	1450
9	408	470	512	548	632	690	718	829	905	887	1025	1119	1053	1219	1332	495	570	622	669	771	841	877	1012	1105	1080	1250	1366	1287	1491	1631
10	453	522	569	609	702	766	798	922	1006	986	1139	1243	1170	1354	1480	550	634	691	743	857	935	974	1125	1228	1200	1389	1518	1430	1657	1812
11	498	574	626	670	773	843	878	1014	1107	1085	1252	1367	1287	1490	1628	605	697	760	817	943	1028	1071	1237	1351	1320	1528	1670	1573	1823	1994
12	544	626	683	731	843	920	958	1106	1207	1183	1366	1491	1404	1625	1776	660	760	829	892	1028	1122	1169	1350	1473	1440	1667	1822	1716	1988	2175
13	589	679	740	792	913	996	1037	1198	1308	1282	1480	1616	1521	1760	1924	715	824	898	966	1114	1215	1266	1462	1596	1560	1806	1974	1859	2154	2356
14	634	731	797	853	983	1073	1117	1290	1408	1380	1594	1740	1638	1896	2072	770	887	967	1040	1200	1309	1364	1575	1719	1680	1944	2125	2002	2320	2537
15	680	783	853	914	1054	1149	1197	1382	1509	1479	1708	1864	1755	2031	2220	825	951	1036	1115	1286	1402	1461	1687	1842	1800	2083	2277	2145	2485	2719
16	725	835	910	974	1124	1226	1277	1474	1609	1578	1822	1989	1872	2167	2368	880	1014	1105	1189	1371	1496	1558	1800	1964	1920	2222	2429	2288	2651	2900
17	770	887	967	1035	1194	1303	1357	1567	1710	1676	1936	2113	1989	2302	2516	935	1077	1174	1263	1457	1589	1656	1912	2087	2040	2361	2581	2431	2817	3081
18	815	939	1024	1096	1264	1379	1436	1659	1811	1775	2050	2237	2106	2438	2664	990	1141	1243	1337	1543	1683	1753	2025	2210	2160	2500	2733	2574	2983	3262
19	861	992	1081	1157	1335	1456	1516	1751	1911	1873	2163	2362	2223	2573	2812	1045	1204	1312	1412	1628	1776	1851	2137	2333	2280	2639	2885	2717	3148	3444
20	906	1044	1138	1218	1405	1533	1596	1843	2012	1972	2277	2486	2340	2708	2960	1100	1267	1382	1486	1714	1870	1948	2250	2456	2400	2778	3036	2860	3314	3625
21	951	1096	1195	1279	1475	1609	1676	1935	2112	2071	2391	2610	2457	2844	3108	1155	1331	1451	1560	1800	1963	2045	2362	2578	2520	2917	3188	3003	3480	3806
22	997	1148	1252	1340	1545	1686	1756	2027	2213	2169	2505	2734	2574	2979	3257	1210	1394	1520	1635	1885	2057	2143	2475	2701	2640	3056	3340	3146	3645	3987
23	1042	1200	1309	1401	1616	1762	1835	2120	2314	2268	2619	2859	2691	3115	3405	1265	1458	1589	1709	1971	2150	2240	2587	2824	2760	3194	3492	3289	3811	4169
24	1087	1253	1365	1462	1686	1839	1915	2212	2414	2366	2733	2983	2808	3250	3553	1320	1521	1658	1783	2057	2244	2338	2699	2947	2880	3333	3644	3432	3977	4350
25	1133	1305	1422	1523	1756	1916	1995	2304	2515	2465	2847	3107	2925	3385	3701	1375	1584	1727	1858	2143	2337	2435	2812	3069	3000	3472	3795	3575	4142	4531
26	1178	1357	1479	1583	1826	1992	2075	2396	2615	2564	2960	3232	3042	3521	3849	1430	1648	1796	1932	2228	2431	2532	2924	3192	3120	3611	3947	3718	4308	4712
27	1223	1409	1536	1644	1897	2069	2155	2488	2716	2662	3074	3356	3159	3656	3997	1485	1711	1865	2006	2314	2524	2630	3037	3315	3240	3750	4099	3861	4474	4894
28	1268	1461	1593	1705	1967	2146	2234	2580	2817	2761	3188	3480	3276	3792	4145	1540	1774	1934	2080	2400	2618	2727	3149	3438	3360	3889	4251	4004	4640	5075
29	1314	1514	1650	1766	2037	2222	2314	2672	2917	2859	3302	3604	3393	3927	4293	1595	1838	2003	2155	2485	2711	2825	3262	3561	3480	4028	4403	4147	4805	5256
30	1359	1566	1707	1827	2107	2299	2394	2765	3018	2958	3416	3729	3510	4063	4441	1650	1901	2072	2229	2571	2805	2922	3374	3683	3600	4167	4555	4290	4971	5437
31	1404	1618	1764	1888	2178	2375	2474	2857	3118	3057	3530	3853	3627	4198	4589	1705	1964	2141	2303	2657	2898	3019	3487	3806	3720	4306	4706	4433	5137	5619
32	1450	1670	1821	1949	2248	2452	2554	2949	3219	3155	3644	3977	3744	4333	4737	1760	2028	2210	2378	2743	2992	3117	3599	3929	3840	4444	4858	4576	5302	5800
33	1495	1722	1878	2010	2318	2529	2633	3041	3320	3254	3757	4102	3861	4469	4885	1815	2091	2280	2452	2828	3085	3214	3712	4052	3960	4583	5010	4719	5468	5981
34	1540	1775	1934	2071	2388	2605	2713	3133	3420	3352	3871	4226	3978	4604	5033	1870	2155	2349	2526	2914	3179	3312	3824	4174	4080	4722	5162	4862	5634	6162
35	1586	1827	1991	2132	2459	2682	2793	3225	3521	3451	3985	4350	4095	4740	5181	1925	2218	2418	2601	3000	3272	3409	3937	4297	4200	4861	5314	5005	5799	6344
36	1631	1879	2048	2192	2529	2759	2873	3318	3621	3550	4099	4474	4212	4875	5329	1980	2281	2487	2675	3085	3366	3506	4049	4420	4320	5000	5465	5148	5965	6525
37	1676	1931	2105	2253	2599	2835	2953	3410	3722	3648	4213	4599	4329	5010	5477	2035	2345	2556	2749	3171	3459	3604	4162	4543	4440	5139	5617	5291	6131	6706
38	1721	1983	2162	2314	2669	2912	3032	3502	3822	3747	4327	4723	4446	5146	5625	2090	2408	2625	2823	3257	3553	3701	4274	4666	4560	5278	5769	5434	6297	6887
39	1767	2036	2219	2375	2740	2988	3112	3594	3923	3845	4441	4847	4563	5281	5773	2145	2471	2694	2898	3342	3646	3799	4387	4788	4680	5417	5921	5577	6462	7069
40	1812	2088	2276	2436	2810	3065	3192	3686	4024	3944	4555	4972	4680	5417	5921	2200	2535	2763	2972	3428	3740	3896	4499	4911	4800	5556	6073	5720	6628	7250
41	1857	2140	2333	2497	2880	3142	3272	3778	4124	4043	4668	5096	4797	5552	6069	2255	2598	2832	3046	3514	3833	3993	4612	5034						
42	1903	2192	2390	2558	2950	3218	3352	3870	4225	4141	4782	5220	4914	5688	6217	2310	2662	2901	3121	3600	3927	4091	4724	5157						
43	1948	2244	2446	2619	3021	3295	3431	3963	4325	4240	4896	5344	5031	5823	6365	2365	2725	2970	3195	3685	4020	4188	4837	5279						
44	1993	2297	2503	2680	3091	3372	3511	4055	4426	4338	5010	5469	5148	5958	6513	2420	2788	3039	3269	3771	4113	4286	4949	5402						
45	203																													

Heat capacity/technical data per section



**zehnder multicolumn, multicolumn completto**

Overall height = 892–1000 mm  $\Phi_L = \Delta T$  50 K EN 442 (SN 384.501-503)

		2090			3090			4090			5090			6090			2100			3100			4100			5100			6100		
Mod.		2090			3090			4090			5090			6090			2100			3100			4100			5100			6100		
T	mm	62			100			136			173			210			62			100			136			173			210		
H	mm	892			900			900			900			900			992			1000			1000			1000			1000		
Exp.	n	1.25			1.27			1.28			1.3			1.31			1.25			1.27			1.29			1.3			1.31		
Sections		Watt 50	Watt 56	Watt 60	Watt 50	Watt 56	Watt 60	Watt 50	Watt 56	Watt 60	Watt 50	Watt 56	Watt 60	Watt 50	Watt 56	Watt 60	Watt 50	Watt 56	Watt 60	Watt 50	Watt 56	Watt 60	Watt 50	Watt 56	Watt 60	Watt 50	Watt 56	Watt 60	Watt 50	Watt 56	Watt 60
4		256	294	321	348	402	439	456	527	576	564	654	715	668	775	848	278	320	349	380	439	480	500	579	633	616	714	781	732	849	929
5		320	368	401	435	502	548	570	659	720	705	817	894	835	969	1060	348	400	436	476	549	599	625	723	791	770	892	976	915	1061	1162
6		383	442	482	522	603	658	684	791	864	846	980	1072	1002	1162	1272	417	480	524	571	659	719	750	868	949	924	1071	1171	1098	1274	1394
7		447	515	562	609	703	768	798	923	1008	987	1144	1251	1169	1356	1484	487	561	611	666	769	839	875	1013	1107	1078	1249	1366	1281	1486	1627
8		511	589	642	696	804	877	912	1054	1152	1128	1307	1430	1336	1550	1696	556	641	698	761	879	959	1000	1157	1265	1232	1428	1562	1464	1698	1859
9		575	663	722	783	904	987	1026	1186	1296	1269	1470	1608	1503	1744	1908	626	721	786	856	988	1079	1125	1302	1423	1386	1606	1757	1647	1911	2091
10		639	736	803	870	1005	1097	1140	1318	1440	1410	1634	1787	1670	1937	2121	695	801	873	951	1098	1199	1250	1447	1581	1540	1784	1952	1830	2123	2324
11		703	810	883	957	1105	1206	1254	1450	1584	1551	1797	1966	1837	2131	2333	765	881	960	1046	1208	1319	1375	1591	1740	1694	1963	2147	2013	2335	2556
12		767	883	963	1044	1206	1316	1368	1582	1728	1692	1961	2145	2004	2325	2545	834	961	1047	1141	1318	1439	1500	1736	1898	1848	2141	2342	2196	2547	2788
13		831	957	1043	1131	1306	1426	1482	1713	1872	1833	2124	2323	2171	2518	2757	904	1041	1135	1236	1428	1558	1625	1881	2056	2002	2320	2537	2379	2760	3021
14		895	1031	1124	1218	1407	1535	1596	1845	2016	1974	2287	2502	2338	2712	2969	973	1121	1222	1331	1538	1678	1750	2025	2214	2156	2498	2733	2562	2972	3253
15		959	1104	1204	1305	1507	1645	1710	1977	2159	2115	2451	2681	2505	2906	3181	1043	1201	1309	1427	1647	1798	1875	2170	2372	2310	2677	2928	2745	3184	3486
16		1022	1178	1284	1392	1607	1755	1824	2109	2303	2256	2614	2859	2672	3100	3393	1112	1281	1397	1522	1757	1918	2000	2315	2530	2464	2855	3123	2928	3397	3718
17		1086	1252	1364	1479	1708	1864	1938	2241	2447	2397	2777	3038	2839	3293	3605	1182	1361	1484	1617	1867	2038	2125	2460	2688	2618	3034	3318	3111	3609	3950
18		1150	1325	1445	1566	1808	1974	2052	2372	2591	2538	2941	3217	3006	3487	3817	1251	1441	1571	1712	1977	2158	2250	2604	2847	2772	3212	3513	3294	3821	4183
19		1214	1399	1525	1653	1909	2084	2166	2504	2735	2679	3104	3396	3173	3681	4029	1321	1521	1658	1807	2087	2278	2375	2749	3005	2926	3390	3709	3477	4033	4415
20		1278	1472	1605	1740	2009	2193	2280	2636	2879	2820	3268	3574	3340	3875	4241	1390	1602	1746	1902	2196	2398	2500	2894	3163	3080	3569	3904	3660	4246	4647
21		1342	1546	1685	1827	2110	2303	2394	2768	3023	2961	3431	3753	3507	4068	4453	1460	1682	1833	1997	2306	2517	2625	3038	3321	3234	3747	4099	3843	4458	4880
22		1406	1620	1766	1914	2210	2413	2508	2900	3167	3102	3594	3932	3674	4262	4665	1529	1762	1920	2092	2416	2637	2750	3183	3479	3388	3926	4294	4026	4670	5112
23		1470	1693	1846	2001	2311	2522	2622	3031	3311	3243	3758	4110	3841	4456	4877	1599	1842	2008	2187	2526	2757	2875	3328	3637	3542	4104	4489	4209	4883	5344
24		1534	1767	1926	2088	2411	2632	2736	3163	3455	3384	3921	4289	4008	4649	5089	1668	1922	2095	2282	2636	2877	3000	3472	3795	3696	4283	4685	4392	5095	5577
25		1598	1841	2006	2175	2512	2742	2850	3295	3599	3525	4085	4468	4175	4843	5301	1738	2002	2182	2378	2746	2997	3125	3617	3954	3850	4461	4880	4575	5307	5809
26		1661	1914	2087	2262	2612	2851	2964	3427	3743	3666	4248	4647	4342	5037	5513	1807	2082	2270	2473	2855	3117	3250	3762	4112	4004	4640	5075	4758	5520	6042
27		1725	1988	2167	2349	2713	2961	3078	3559	3887	3807	4411	4825	4509	5231	5725	1877	2162	2357	2568	2965	3237	3375	3906	4270	4158	4818	5270	4941	5732	6274
28		1789	2061	2247	2436	2813	3071	3192	3690	4031	3948	4575	5004	4676	5424	5937	1946	2242	2444	2663	3075	3357	3500	4051	4428	4312	4996	5465	5124	5944	6506
29		1853	2135	2327	2523	2914	3180	3306	3822	4175	4089	4738	5183	4843	5618	6150	2016	2322	2531	2758	3185	3476	3625	4196	4586	4466	5175	5660	5307	6156	6739
30		1917	2209	2408	2610	3014	3290	3420	3954	4319	4230	4901	5361	5010	5812	6362	2085	2402	2619	2853	3295	3596	3750	4340	4744	4620	5353	5856	5490	6369	6971
31		1981	2282	2488	2697	3114	3400	3534	4086	4463	4371	5065	5540	5177	6006	6574	2155	2482	2706	2948	3404	3716	3875	4485	4902	4774	5532	6051	5673	6581	7203
32		2045	2356	2568	2784	3215	3509	3648	4217	4607	4512	5228	5719	5344	6199	6786	2224	2562	2793	3043	3514	3836	4000	4630	5061	4928	5710	6246	5856	6793	7436
33		2109	2430	2648	2871	3315	3619	3762	4349	4751	4653	5392	5898	5511	6393	6998	2294	2643	2881	3138	3624	3956	4125	4774	5219	5082	5889	6441	6039	7006	7668
34		2173	2503	2729	2958	3416	3729	3876	4481	4895	4794	5555	6076	5678	6587	7210	2363	2723	2968	3233	3734	4076	4250	4919	5377	5236	6067	6636	6222	7218	7901
35		2237	2577	2809	3045	3516	3838	3990	4613	5039	4935	5718	6255	5845	6780	7422	2433	2803	3055	3329	3844	4196	4375	5064	5535	5390	6246	6832	6405	7430	8133
36		2300	2650	2889	3132	3617	3948	4104	4745	5183	5076	5882	6434	6012	6974	7634	2502	2883	3142	3424	3954	4316	4500	5208	5693	5544	6424	7027	6588	7642	8365
37		2364	2724	2969	3219	3717	4058	4218	4876	5327	5217	6045	6612	6179	7168	7846	2572	2963	3230	3519	4063	4435	4625	5353	5851	5698	6602	7222	6771	7855	8598
38		2428	2798	3050	3306	3818	4167	4332	5008	5471	5358	6208	6791	6346	7362	8058	2641	3043	3317	3614	4173	4555	4750	5498	6009	5852	6781	7417	6954	8067	8830
39		2492	2871	3130	3393	3918	4277	4446	5140	5615	5499	6372	6970	6513	7555	8270	2711	3123	3404	3709	4283	4675	4875	5642	6168	6006	6959	7612	7137	8279	9062
40		2556	2945	3210	3480	4019	4387	4560	5272	5759	5640	6535	7148	6680	7749	8482	2780	3203	3492	3804	4393	4795	5000	5787	6326	6160	7138	7808	7320	8492	9295
41		2620	3019	3290	3567	4119	4496	4674	5404	5903							2850	3283	3579	3899	4503	4915	5125	5932	6484						
42		2684	3092	3371	3654	4220	4606	4788	5535	6047							2919	3363	3666	3994	4613	5035	5250	6076	6642						
43		2748	3166	3451	3741	4320	4716	4902	5667	6190							2989														

Heat capacity/technical data per section

**zehnder** *multicolumn, multicolumn completto*



Overall height = 1092–1200 mm  $\Phi_L = \Delta T$  50 K EN 442 (SN 384.501-503)

		2110			3110			4110			5110			6110			2120			3120			4120			5120			6120		
Mod.																															
T	mm	62			100			136			173			210			62			100			136			173			210		
H	mm	1092			1100			1100			1100			1100			992			1200			1200			1200			1200		
Exp.	n	1.25			1.28			1.29			1.31			1.32			1.25			1.29			1.3			1.31			1.32		
Sections		Watt 50	Watt 56	Watt 60	Watt 50	Watt 56	Watt 60	Watt 50	Watt 56	Watt 60	Watt 50	Watt 56	Watt 60	Watt 50	Watt 56	Watt 60	Watt 50	Watt 56	Watt 60	Watt 50	Watt 56	Watt 60	Watt 50	Watt 56	Watt 60	Watt 50	Watt 56	Watt 60	Watt 50	Watt 56	Watt 60
4		299	344	375	412	476	520	540	625	683	668	775	848	792	920	1007	331	382	416	460	532	582	588	681	745	716	831	909	840	976	1069
5		374	430	469	515	595	650	675	781	854	835	969	1060	990	1150	1259	414	477	520	575	666	727	735	852	932	895	1038	1136	1050	1219	1336
6		448	516	563	618	714	780	810	938	1025	1002	1162	1272	1188	1380	1511	496	572	624	690	799	873	882	1022	1118	1074	1246	1364	1260	1463	1603
7		523	602	657	721	834	911	945	1094	1196	1169	1356	1484	1386	1610	1763	579	668	728	805	932	1018	1029	1192	1304	1253	1454	1591	1470	1707	1870
8		598	689	751	824	953	1041	1080	1250	1366	1336	1550	1696	1584	1840	2015	662	763	832	920	1065	1164	1176	1363	1491	1432	1661	1818	1680	1951	2137
9		672	775	844	927	1072	1171	1215	1406	1537	1503	1744	1908	1782	2070	2267	744	859	937	1035	1198	1309	1323	1533	1677	1611	1869	2046	1890	2195	2404
10		747	861	938	1030	1191	1301	1350	1563	1708	1670	1937	2121	1980	2299	2519	827	954	1041	1150	1331	1455	1470	1703	1863	1790	2076	2273	2100	2439	2671
11		822	947	1032	1133	1310	1431	1485	1719	1879	1837	2131	2333	2178	2529	2771	910	1049	1145	1265	1464	1600	1617	1874	2049	1969	2284	2500	2310	2683	2939
12		896	1033	1126	1236	1429	1561	1620	1875	2050	2004	2325	2545	2376	2759	3022	992	1145	1249	1380	1597	1746	1764	2044	2236	2148	2492	2727	2520	2927	3206
13		971	1119	1220	1339	1548	1691	1755	2031	2220	2171	2518	2757	2574	2989	3274	1075	1240	1353	1495	1730	1891	1911	2214	2422	2327	2699	2955	2730	3171	3473
14		1046	1205	1313	1442	1667	1821	1890	2188	2391	2338	2712	2969	2772	3219	3526	1158	1336	1457	1610	1863	2037	2058	2385	2608	2506	2907	3182	2940	3414	3740
15		1121	1291	1407	1545	1786	1951	2025	2344	2562	2505	2906	3181	2970	3449	3778	1241	1431	1561	1725	1997	2182	2205	2555	2795	2685	3115	3409	3150	3658	4007
16		1195	1377	1501	1648	1905	2081	2160	2500	2733	2672	3100	3393	3168	3679	4030	1323	1526	1665	1840	2130	2328	2352	2725	2981	2864	3322	3637	3360	3902	4274
17		1270	1463	1595	1751	2024	2211	2295	2656	2904	2839	3293	3605	3366	3909	4282	1406	1622	1769	1955	2263	2473	2499	2896	3167	3043	3530	3864	3570	4146	4541
18		1345	1549	1689	1854	2143	2341	2430	2813	3074	3006	3487	3817	3564	4139	4534	1489	1717	1873	2070	2396	2619	2646	3066	3354	3222	3738	4091	3780	4390	4809
19		1419	1635	1783	1957	2263	2471	2565	2969	3245	3173	3681	4029	3762	4369	4786	1571	1812	1977	2185	2529	2764	2793	3236	3540	3401	3945	4319	3990	4634	5076
20		1494	1721	1876	2060	2382	2601	2700	3125	3416	3340	3875	4241	3960	4599	5037	1654	1908	2081	2300	2662	2910	2940	3407	3726	3580	4153	4546	4200	4878	5343
21		1569	1807	1970	2163	2501	2732	2835	3281	3587	3507	4068	4453	4158	4829	5289	1737	2003	2185	2415	2795	3055	3087	3577	3913	3759	4361	4773	4410	5122	5610
22		1643	1894	2064	2266	2620	2862	2970	3438	3758	3674	4262	4665	4356	5059	5541	1819	2099	2289	2530	2928	3201	3234	3747	4099	3938	4568	5000	4620	5365	5877
23		1718	1980	2158	2369	2739	2992	3105	3594	3928	3841	4456	4877	4554	5289	5793	1902	2194	2393	2645	3061	3346	3381	3918	4285	4117	4776	5228	4830	5609	6144
24		1793	2066	2252	2472	2858	3122	3240	3750	4099	4008	4649	5089	4752	5519	6045	1985	2289	2497	2760	3194	3492	3528	4088	4472	4296	4984	5455	5040	5853	6411
25		1868	2152	2346	2575	2977	3252	3375	3906	4270	4175	4843	5301	4950	5749	6297	2068	2385	2601	2875	3328	3637	3675	4258	4658	4475	5191	5682	5250	6097	6678
26		1942	2238	2439	2678	3096	3382	3510	4063	4441	4342	5037	5513	5148	5979	6549	2150	2480	2705	2990	3461	3783	3822	4429	4844	4654	5399	5910	5460	6341	6946
27		2017	2324	2533	2781	3215	3512	3645	4219	4611	4509	5231	5725	5346	6209	6801	2233	2576	2810	3105	3594	3928	3969	4599	5031	4833	5607	6137	5670	6585	7213
28		2092	2410	2627	2884	3334	3642	3780	4375	4782	4676	5424	5937	5544	6439	7052	2316	2671	2914	3220	3727	4074	4116	4769	5217	5012	5814	6364	5880	6829	7480
29		2166	2496	2721	2987	3453	3772	3915	4531	4953	4843	5618	6150	5742	6669	7304	2398	2766	3018	3335	3860	4219	4263	4940	5403	5191	6022	6591	6090	7073	7747
30		2241	2582	2815	3090	3572	3902	4050	4688	5124	5010	5812	6362	5940	6898	7556	2481	2862	3122	3450	3993	4365	4410	5110	5590	5370	6229	6819	6300	7317	8014
31		2316	2668	2908	3193	3691	4032	4185	4844	5295	5177	6006	6574	6138	7128	7808	2564	2957	3226	3565	4126	4510	4557	5280	5776	5549	6437	7046	6510	7560	8281
32		2390	2754	3002	3296	3811	4162	4320	5000	5465	5344	6199	6786	6336	7358	8060	2646	3053	3330	3680	4259	4656	4704	5451	5962	5728	6645	7273	6720	7804	8548
33		2465	2840	3096	3399	3930	4292	4455	5156	5636	5511	6393	6998	6534	7588	8312	2729	3148	3434	3795	4392	4801	4851	5621	6148	5907	6852	7501	6930	8048	8816
34		2540	2926	3190	3502	4049	4423	4590	5313	5807	5678	6587	7210	6732	7818	8564	2812	3243	3538	3910	4526	4947	4998	5791	6335	6086	7060	7728	7140	8292	9083
35		2615	3012	3284	3605	4168	4553	4725	5469	5978	5845	6780	7422	6930	8048	8816	2895	3339	3642	4025	4659	5092	5145	5962	6521	6265	7268	7955	7350	8536	9350
36		2689	3098	3378	3708	4287	4683	4860	5625	6149	6012	6974	7634	7128	8278	9067	2977	3434	3746	4140	4792	5238	5292	6132	6707	6444	7475	8182	7560	8780	9617
37		2764	3185	3471	3811	4406	4813	4995	5781	6319	6179	7168	7846	7326	8508	9319	3060	3530	3850	4255	4925	5383	5439	6302	6894	6623	7683	8410	7770	9024	9884
38		2839	3271	3565	3914	4525	4943	5130	5938	6490	6346	7362	8058	7524	8738	9571	3143	3625	3954	4370	5058	5529	5586	6473	7080	6802	7891	8637	7980	9268	10151
39		2913	3357	3659	4017	4644	5073	5265	6094	6661	6513	7555	8270	7722	8968	9823	3225	3720	4058	4485	5191	5674	5733	6643	7266	6981	8098	8864	8190	9512	10418
40		2988	3443	3753	4120	4763	5203	5400	6250	6832	6680	7749	8482	7920	9198	10075	3308	3816	4162	4600	5324	5820	5880	6813	7453	7160	8306	9092	8400	9755	10686
41		3063	3529	3847	4223	4882	5333	5535	6406	7003							3391	3911	4266	4715	5457	5965	6027	6984	7639						
42		3137	3615	3940	4326	5001	5463	5670	6563	7173							3473	4007	4370	4830	5590	6111	6174	7154	7825						
43		3212	3701	4034	4429	5120	5593	5805	6719	7344																					

Heat capacity/technical data per section



**zehnder** multicolumn, multicolumn completto

Overall height = 1492–1800 mm

$\Phi_L = \Delta T \text{ 50 K EN 442}$  (SN 384.501-503)

Mod.		2150			3150			4150			5150			6150			2180			3180			4180			5180			6180				
T	mm	62			100			136			173			210			62			100			136			173			210				
H	mm	1492			1500			1500			1500			1500			1792			1800			1800			1800			1800				
Exp.	n	1.28			1.31			1.31			1.32			1.32			1.31			1.33			1.33			1.32			1.33				
Sections		Watt 50	Watt 56	Watt 60	Watt 50	Watt 56	Watt 60	Watt 50	Watt 56	Watt 60	Watt 50	Watt 56	Watt 60	Watt 50	Watt 56	Watt 60	Watt 50	Watt 56	Watt 60	Watt 50	Watt 56	Watt 60	Watt 50	Watt 56	Watt 60	Watt 50	Watt 56	Watt 60	Watt 50	Watt 56	Watt 60		
4		416	481	525	560	650	711	720	835	914	876	1017	1114	1024	1189	1303	496	575	630	664	772	846	852	991	1086	1036	1203	1318	1212	1409	1545		
5		520	601	657	700	812	889	900	1044	1143	1095	1272	1393	1280	1487	1628	620	719	787	830	965	1058	1065	1238	1357	1295	1504	1647	1515	1761	1931		
6		624	721	788	840	974	1067	1080	1253	1371	1314	1526	1672	1536	1784	1954	744	863	945	996	1158	1269	1278	1486	1629	1554	1805	1977	1818	2114	2317		
7		728	842	919	980	1137	1244	1260	1462	1600	1533	1780	1950	1792	2081	2280	868	1007	1102	1162	1351	1481	1491	1734	1900	1813	2106	2306	2121	2466	2703		
8		832	962	1051	1120	1299	1422	1440	1670	1828	1752	2035	2229	2048	2378	2605	992	1151	1260	1328	1544	1692	1704	1981	2172	2072	2406	2636	2424	2818	3089		
9		936	1082	1182	1260	1462	1600	1620	1879	2057	1971	2289	2507	2304	2676	2931	1116	1295	1417	1494	1737	1904	1917	2229	2443	2331	2707	2965	2727	3171	3475		
10		1040	1202	1313	1400	1624	1778	1800	2088	2286	2190	2543	2786	2560	2973	3257	1240	1438	1575	1660	1930	2116	2130	2477	2715	2590	3008	3295	3030	3523	3861		
11		1144	1323	1445	1540	1786	1955	1980	2297	2514	2409	2798	3064	2816	3270	3582	1364	1582	1732	1826	2123	2327	2343	2724	2986	2849	3309	3624	3333	3875	4248		
12		1248	1443	1576	1680	1949	2133	2160	2506	2743	2628	3052	3343	3072	3568	3908	1488	1726	1889	1992	2316	2539	2556	2972	3257	3108	3610	3954	3636	4228	4634		
13		1352	1563	1707	1820	2111	2311	2340	2715	2971	2847	3306	3622	3328	3865	4234	1612	1870	2047	2158	2509	2750	2769	3219	3529	3367	3910	4283	3939	4580	5020		
14		1456	1683	1839	1960	2274	2489	2520	2923	3200	3066	3561	3900	3584	4162	4559	1736	2014	2204	2324	2702	2962	2982	3467	3800	3626	4211	4613	4242	4932	5406		
15		1560	1804	1970	2100	2436	2667	2700	3132	3428	3285	3815	4179	3840	4460	4885	1860	2158	2362	2490	2895	3173	3195	3715	4072	3885	4512	4942	4545	5284	5792		
16		1664	1924	2101	2240	2599	2844	2880	3341	3657							1984	2302	2519	2656	3088	3385	3408	3962	4343								
17		1768	2044	2233	2380	2761	3022	3060	3550	3886							2108	2445	2677	2822	3281	3596	3621	4210	4615								
18		1872	2164	2364	2520	2923	3200	3240	3759	4114							2232	2589	2834	2988	3474	3808	3834	4458	4886								
19		1976	2284	2495	2660	3086	3378	3420	3967	4343							2356	2733	2992	3154	3667	4020	4047	4705	5158								
20		2080	2405	2627	2800	3248	3555	3600	4176	4571							2480	2877	3149	3320	3860	4231	4260	4953	5429								
21		2184	2525	2758													2604	3021	3306														
22		2288	2645	2889													2728	3165	3464														
23		2392	2765	3021													2852	3308	3621														
24		2496	2886	3152													2976	3452	3779														
25		2600	3006	3283													3100	3596	3936														
26		2704	3126	3415													3224	3740	4094														
27		2808	3246	3546													3348	3884	4251														
28		2912	3367	3677													3472	4028	4409														
29		3016	3487	3809													3596	4172	4566														
30		3120	3607	3940													3720	4315	4724														
31																																	
32																																	
33																																	
34																																	
35																																	
36																																	
37																																	
38																																	
39																																	
40																																	
41																																	
42																																	
43																																	
44																																	
45																																	
46																																	
47																																	
48																																	
49																																	
50																																	

Heat capacity/technical data per section

**zehnder** multicolumn, multicolumn completo



Overall height = 1992–2200 mm  $\Phi_L = \Delta T 50 K EN 442$  (SN 384.501-503)

Mod.	2200			3200			4200			5200			6200			2220			3220			4220			5220			6220			
T mm	62			100			136			173			210			62			100			136			173			210			
H mm	1992			2000			2000			2000			2000			2192			2200			2200			2200			2200			
Exp. n	1.31			1.33			1.32			1.32			1.32			1.31			1.32			1.32			1.32			1.32			
Sections	Watt 50	Watt 56	Watt 60	Watt 50	Watt 56	Watt 60	Watt 50	Watt 56	Watt 60	Watt 50	Watt 56	Watt 60	Watt 50	Watt 56	Watt 60	Watt 50	Watt 56	Watt 60	Watt 50	Watt 56	Watt 60	Watt 50	Watt 56	Watt 60	Watt 50	Watt 56	Watt 60	Watt 50	Watt 56	Watt 60	
4	552	640	701	732	851	933	936	1087	1191	1140	1324	1450	1336	1552	1700	604	701	767	800	929	1018	1024	1189	1303	1248	1449	1588	1460	1696	1857	
5	690	800	876	915	1064	1166	1170	1359	1488	1425	1655	1813	1670	1939	2124	755	876	959	1000	1161	1272	1280	1487	1628	1560	1812	1984	1825	2119	2322	
6	828	961	1051	1098	1277	1399	1404	1631	1786	1710	1986	2175	2004	2327	2549	906	1051	1150	1200	1394	1527	1536	1784	1954	1872	2174	2381	2190	2543	2786	
7	966	1121	1227	1281	1489	1633	1638	1902	2084	1995	2317	2538	2338	2715	2974	1057	1226	1342	1400	1626	1781	1792	2081	2280	2184	2536	2778	2555	2967	3250	
8	1104	1281	1402	1464	1702	1866	1872	2174	2381	2280	2648	2900	2672	3103	3399	1208	1401	1534	1600	1858	2035	2048	2378	2605	2496	2899	3175	2920	3391	3715	
9	1242	1441	1577	1647	1915	2099	2106	2446	2679	2565	2979	3263	3006	3491	3824	1359	1577	1726	1800	2090	2290	2304	2676	2931	2808	3261	3572	3285	3815	4179	
10	1380	1601	1752	1830	2128	2332	2340	2718	2977	2850	3310	3625	3340	3879	4249	1510	1752	1917	2000	2323	2544	2560	2973	3257	3120	3623	3969	3650	4239	4643	
11	1518	1761	1928	2013	2340	2565	2574	2989	3274	3135	3641	3988	3674	4267	4674	1661	1927	2109	2200	2555	2799	2816	3270	3582	3432	3986	4366	4015	4663	5107	
12	1656	1921	2103	2196	2553	2799	2808	3261	3572	3420	3972	4351	4008	4655	5099	1812	2102	2301	2400	2787	3053	3072	3568	3908	3744	4348	4763	4380	5087	5572	
13	1794	2081	2278	2379	2766	3032	3042	3533	3870	3705	4303	4713	4342	5043	5523	1963	2277	2493	2600	3020	3307	3328	3865	4234	4056	4710	5160	4745	5511	6036	
14	1932	2241	2453	2562	2979	3265	3276	3805	4167	3990	4634	5076	4676	5431	5948	2114	2452	2684	2800	3252	3562	3584	4162	4559	4368	5073	5557	5110	5935	6500	
15	2070	2401	2628	2745	3192	3498	3510	4076	4465	4275	4965	5438	5010	5818	6373	2265	2628	2876	3000	3484	3816	3840	4460	4885	4680	5435	5953	5475	6358	6965	
16	2208	2561	2804	2928	3404	3731	3744	4348	4763							2416	2803	3068	3200	3716	4071	4096	4757	5210							
17	2346	2721	2979	3111	3617	3965	3978	4620	5060							2567	2978	3260	3400	3949	4325	4352	5054	5536							
18	2484	2882	3154	3294	3830	4198	4212	4892	5358							2718	3153	3451	3600	4181	4580	4608	5352	5862							
19	2622	3042	3329	3477	4043	4431	4446	5163	5656							2869	3328	3643	3800	4413	4834	4864	5649	6187							
20	2760	3202	3505	3660	4255	4664	4680	5435	5953							3020	3503	3835	4000	4645	5088	5120	5946	6513							
21	2898	3362	3680													3171	3679	4026													
22	3036	3522	3855													3322	3854	4218													
23	3174	3682	4030													3473	4029	4410													
24	3312	3842	4206													3624	4204	4602													
25	3450	4002	4381													3775	4379	4793													
26	3588	4162	4556													3926	4554	4985													
27	3726	4322	4731													4077	4730	5177													
28	3864	4482	4906													4228	4905	5369													
29	4002	4643	5082													4379	5080	5560													
30	4140	4803	5257													4530	5255	5752													
31																															
32																															
33																															
34																															
35																															
36																															
37																															
38																															
39																															
40																															
41																															
42																															
43																															
44																															
45																															
46																															
47																															
48																															
49																															
50																															

Heat capacity/technical data per section

**zehnder** multicolumn, multicolumn completto



Overall height = 2492–2800 mm

$\Phi_L = \Delta T 50 K EN 442$  (SN 384.501-503)

Mod.		2250			3250			4250			5250			6250			2280			3280			4280			5280			6280		
T	mm	62			100			136			173			210			62			100			136			173			210		
H	mm	2492			2500			2500			2500			2500			2792			2800			2800			2800			2800		
Exp.	n	1.			1.32			1.31			1.31			1.32			1.3			1.3			1.3			1.3			1.3		
Sections		Watt 50	Watt 56	Watt 60	Watt 50	Watt 56	Watt 60	Watt 50	Watt 56	Watt 60	Watt 50	Watt 56	Watt 60	Watt 50	Watt 56	Watt 60	Watt 50	Watt 56	Watt 60	Watt 50	Watt 56	Watt 60	Watt 50	Watt 56	Watt 60	Watt 50	Watt 56	Watt 60	Watt 50	Watt 56	Watt 60
4		684	793	867	900	1045	1145	1156	1341	1468	1408	1633	1788	1648	1914	2096	756	876	958	1004	1163	1273	1292	1497	1638	1568	1817	1987	1836	2127	2327
5		855	991	1084	1125	1307	1431	1445	1676	1835	1760	2042	2235	2060	2392	2621	945	1095	1198	1255	1454	1591	1615	1871	2047	1960	2271	2484	2295	2659	2909
6		1026	1189	1300	1350	1568	1717	1734	2012	2202	2112	2450	2682	2472	2871	3145	1134	1314	1437	1506	1745	1909	1938	2246	2456	2352	2725	2981	2754	3191	3491
7		1197	1387	1517	1575	1829	2004	2023	2347	2569	2464	2858	3129	2884	3349	3669	1323	1533	1677	1757	2036	2227	2261	2620	2866	2744	3180	3478	3213	3723	4072
8		1368	1585	1734	1800	2090	2290	2312	2682	2936	2816	3267	3576	3296	3828	4193	1512	1752	1916	2008	2327	2545	2584	2994	3275	3136	3634	3975	3672	4255	4654
9		1539	1783	1951	2025	2352	2576	2601	3017	3303	3168	3675	4023	3708	4306	4717	1701	1971	2156	2259	2618	2863	2907	3368	3685	3528	4088	4472	4131	4787	5236
10		1710	1981	2167	2250	2613	2862	2890	3353	3670	3520	4083	4470	4120	4785	5241	1890	2190	2396	2510	2908	3181	3230	3743	4094	3920	4542	4968	4590	5319	5818
11		1881	2180	2384	2475	2874	3148	3179	3688	4037	3872	4492	4917	4532	5263	5765	2079	2409	2635	2761	3199	3499	3553	4117	4503	4312	4996	5465	5049	5850	6399
12		2052	2378	2601	2700	3136	3435	3468	4023	4404	4224	4900	5364	4944	5742	6289	2268	2628	2875	3012	3490	3818	3876	4491	4913	4704	5451	5962	5508	6382	6981
13		2223	2576	2818	2925	3397	3721	3757	4358	4771	4576	5308	5810	5356	6220	6813	2457	2847	3114	3263	3781	4136	4199	4866	5322	5096	5905	6459	5967	6914	7563
14		2394	2774	3034	3150	3658	4007	4046	4694	5138	4928	5717	6257	5768	6699	7337	2646	3066	3354	3514	4072	4454	4522	5240	5731	5488	6359	6956	6426	7446	8145
15		2565	2972	3251	3375	3920	4293	4335	5029	5504	5280	6125	6704	6180	7177	7862	2835	3285	3593	3765	4363	4772	4845	5614	6141	5880	6813	7453	6885	7978	8726
16		2736	3170	3468	3600	4181	4580	4624	5364	5871							3024	3504	3833	4016	4653	5090	5168	5988	6550						
17		2907	3368	3685	3825	4442	4866	4913	5699	6238							3213	3723	4072	4267	4944	5408	5491	6363	6960						
18		3078	3567	3901	4050	4704	5152	5202	6035	6605							3402	3942	4312	4518	5235	5726	5814	6737	7369						
19		3249	3765	4118	4275	4965	5438	5491	6370	6972							3591	4161	4551	4769	5526	6045	6137	7111	7778						
20		3420	3963	4335	4500	5226	5724	5780	6705	7339							3780	4380	4791	5020	5817	6363	6460	7485	8188						
21		3591	4161	4551													3969	4599	5031												
22		3762	4359	4768													4158	4818	5270												
23		3933	4557	4985													4347	5037	5510												
24		4104	4755	5202													4536	5256	5749												
25		4275	4954	5418													4725	5475	5989												
26		4446	5152	5635													4914	5694	6228												
27		4617	5350	5852													5103	5913	6468												
28		4788	5548	6069													5292	6132	6707												
29		4959	5746	6285													5481	6351	6947												
30		5130	5944	6502													5670	6570	7187												
31																															
32																															
33																															
34																															
35																															
36																															
37																															
38																															
39																															
40																															
41																															
42																															
43																															
44																															
45																															
46																															
47																															
48																															
49																															
50																															

Heat capacity/technical data per section



## zehnder multicolumn, multicolumn completo

Overall height = 2992–3000 mm

$\Phi_L = \Delta T 50 K EN 442$  (SN 384.501-503)

Mod.	2300			3300			4300			5300			6300							
	T mm	H mm	Exp. n	T mm	H mm	Exp. n	T mm	H mm	Exp. n	T mm	H mm	Exp. n	T mm	H mm	Exp. n					
<b>Sections</b>	<b>Watt 50</b>	<b>Watt 56</b>	<b>Watt 60</b>	<b>Watt 50</b>	<b>Watt 56</b>	<b>Watt 60</b>	<b>Watt 50</b>	<b>Watt 56</b>	<b>Watt 60</b>	<b>Watt 50</b>	<b>Watt 56</b>	<b>Watt 60</b>	<b>Watt 50</b>	<b>Watt 56</b>	<b>Watt 60</b>					
4	804	932	1019	1076	1247	1364	1380	1599	1749	1680	1947	2129	1964	2276	2489					
5	1005	1165	1274	1345	1558	1705	1725	1999	2186	2100	2433	2662	2455	2845	3112					
6	1206	1397	1529	1614	1870	2046	2070	2399	2624	2520	2920	3194	2946	3414	3734					
7	1407	1630	1783	1883	2182	2387	2415	2798	3061	2940	3407	3726	3437	3983	4356					
8	1608	1863	2038	2152	2494	2728	2760	3198	3498	3360	3893	4259	3928	4552	4979					
9	1809	2096	2293	2421	2805	3069	3105	3598	3935	3780	4380	4791	4419	5120	5601					
10	2010	2329	2548	2690	3117	3409	3450	3998	4373	4200	4867	5323	4910	5689	6223					
11	2211	2562	2802	2959	3429	3750	3795	4397	4810	4620	5353	5856	5401	6258	6846					
12	2412	2795	3057	3228	3740	4091	4140	4797	5247	5040	5840	6388	5892	6827	7468					
13	2613	3028	3312	3497	4052	4432	4485	5197	5685	5460	6327	6920	6383	7396	8090					
14	2814	3261	3567	3766	4364	4773	4830	5597	6122	5880	6813	7453	6874	7965	8713					
15	3015	3494	3821	4035	4675	5114	5175	5996	6559	6300	7300	7985	7365	8534	9335					
16	3216	3726	4076	4304	4987	5455	5520	6396	6996											
17	3417	3959	4331	4573	5299	5796	5865	6796	7434											
18	3618	4192	4586	4842	5611	6137	6210	7196	7871											
19	3819	4425	4840	5111	5922	6478	6555	7595	8308											
20	4020	4658	5095	5380	6234	6819	6900	7995	8746											
21	4221	4891	5350																	
22	4422	5124	5605																	
23	4623	5357	5859																	
24	4824	5590	6114																	
25	5025	5823	6369																	
26	5226	6056	6624																	
27	5427	6288	6879																	
28	5628	6521	7133																	
29	5829	6754	7388																	
30	6030	6987	7643																	
31																				
32																				
33																				
34																				
35																				
36																				
37																				
38																				
39																				
40																				
41																				
42																				
43																				
44																				
45																				
46																				
47																				
48																				
49																				
50																				



Heat capacity/technical data per section

**zehnder** *multicolumn klinik*



Overall height = 292–350 mm

$\Phi_L = \Delta T$  50 K EN 442 (SN 384.501-503)

Mod.	K2030			K3030			K4030			K5030			K6030			K2035			K3035			K4035			K5035			K6035								
	T mm	H mm	Exp. n	T mm	H mm	Exp. n	T mm	H mm	Exp. n	T mm	H mm	Exp. n	T mm	H mm	Exp. n	T mm	H mm	Exp. n	T mm	H mm	Exp. n	T mm	H mm	Exp. n	T mm	H mm	Exp. n	T mm	H mm	Exp. n						
<b>Sections</b>	<b>Watt 50</b>	<b>Watt 56</b>	<b>Watt 60</b>	<b>Watt 50</b>	<b>Watt 56</b>	<b>Watt 60</b>	<b>Watt 50</b>	<b>Watt 56</b>	<b>Watt 60</b>	<b>Watt 50</b>	<b>Watt 56</b>	<b>Watt 60</b>	<b>Watt 50</b>	<b>Watt 56</b>	<b>Watt 60</b>	<b>Watt 50</b>	<b>Watt 56</b>	<b>Watt 60</b>	<b>Watt 50</b>	<b>Watt 56</b>	<b>Watt 60</b>	<b>Watt 50</b>	<b>Watt 56</b>	<b>Watt 60</b>	<b>Watt 50</b>	<b>Watt 56</b>	<b>Watt 60</b>	<b>Watt 50</b>	<b>Watt 56</b>	<b>Watt 60</b>	<b>Watt 50</b>	<b>Watt 56</b>	<b>Watt 60</b>	<b>Watt 50</b>	<b>Watt 56</b>	<b>Watt 60</b>
<b>4</b>	106	123	134	144	166	181	182	210	229	223	257	280	265	306	335	117	136	148	164	190	208	209	241	263	256	295	322	305	353	386						
<b>5</b>	133	153	168	180	207	226	228	262	286	279	321	350	331	383	419	147	170	185	206	238	260	262	302	329	320	369	402	381	441	482						
<b>6</b>	159	184	201	215	249	272	273	315	344	334	385	420	397	460	503	176	203	222	247	285	311	314	362	395	384	442	482	457	529	578						
<b>7</b>	186	215	235	251	290	317	319	367	401	390	449	490	463	536	586	205	237	259	288	333	363	366	422	461	448	516	563	533	617	675						
<b>8</b>	212	245	268	287	332	362	364	420	458	446	513	560	530	613	670	234	271	297	329	380	415	418	483	526	512	590	643	610	706	771						
<b>9</b>	239	276	302	323	373	407	410	472	515	501	578	630	596	690	754	264	305	334	370	428	467	471	543	592	576	664	723	686	794	868						
<b>10</b>	265	307	335	359	415	453	455	525	573	557	642	700	662	766	838	293	339	371	411	475	519	523	603	658	640	737	804	762	882	964						
<b>11</b>	292	337	369	395	456	498	501	577	630	613	706	770	728	843	921	322	373	408	452	523	571	575	664	724	704	811	884	838	970	1060						
<b>12</b>	318	368	402	431	497	543	546	630	687	668	770	839	794	919	1005	352	407	445	493	570	623	628	724	790	768	885	965	914	1058	1157						
<b>13</b>	345	399	436	467	539	588	592	682	744	724	834	909	861	996	1089	381	441	482	534	618	675	680	784	855	832	959	1045	991	1147	1253						
<b>14</b>	371	429	469	503	580	634	637	735	802	780	898	979	927	1073	1173	410	475	519	575	665	727	732	845	921	896	1032	1125	1067	1235	1350						
<b>15</b>	398	460	503	539	622	679	683	787	859	836	963	1049	993	1149	1256	440	509	556	617	713	779	785	905	987	960	1106	1206	1143	1323	1446						
<b>16</b>	424	491	536	574	663	724	728	840	916	891	1027	1119	1059	1226	1340	469	543	593	658	760	830	837	965	1053	1024	1180	1286	1219	1411	1542						
<b>17</b>	451	521	570	610	705	769	774	892	973	947	1091	1189	1125	1303	1424	498	577	630	699	808	882	889	1026	1119	1088	1254	1366	1295	1499	1639						
<b>18</b>	477	552	603	646	746	815	819	945	1031	1003	1155	1259	1192	1379	1508	527	610	667	740	855	934	941	1086	1185	1152	1327	1447	1372	1588	1735						
<b>19</b>	504	583	637	682	788	860	865	997	1088	1058	1219	1329	1258	1456	1591	557	644	704	781	903	986	994	1146	1250	1216	1401	1527	1448	1676	1832						
<b>20</b>	530	613	671	718	829	905	910	1050	1145	1114	1284	1399	1324	1532	1675	586	678	741	822	950	1038	1046	1207	1316	1280	1475	1608	1524	1764	1928						
<b>21</b>	557	644	704	754	871	950	956	1102	1202	1170	1348	1469	1390	1609	1759	615	712	778	863	998	1090	1098	1267	1382	1344	1549	1688	1600	1852	2025						
<b>22</b>	583	675	738	790	912	996	1001	1155	1260	1225	1412	1539	1456	1686	1843	645	746	816	904	1045	1142	1151	1327	1448	1408	1622	1768	1676	1940	2121						
<b>23</b>	610	705	771	826	954	1041	1047	1207	1317	1281	1476	1609	1523	1762	1926	674	780	853	945	1093	1194	1203	1388	1514	1472	1696	1849	1753	2028	2217						
<b>24</b>	636	736	805	862	995	1086	1092	1260	1374	1337	1540	1679	1589	1839	2010	703	814	890	986	1140	1246	1255	1448	1579	1536	1770	1929	1829	2117	2314						
<b>25</b>	663	767	838	898	1036	1131	1138	1312	1431	1393	1604	1749	1655	1912	2094	733	848	927	1028	1188	1298	1308	1508	1645	1600	1843	2010	1905	2205	2410						
<b>26</b>	689	797	872	933	1078	1177	1183	1365	1489	1448	1669	1819	1721	1992	2178	762	882	964	1069	1235	1349	1360	1569	1711	1664	1917	2090	1981	2293	2507						
<b>27</b>	716	828	905	969	1119	1222	1229	1417	1546	1504	1733	1889	1787	2069	2261	791	916	1001	1110	1283	1401	1412	1629	1777	1728	1991	2170	2057	2381	2603						
<b>28</b>	742	859	939	1005	1161	1267	1274	1470	1603	1560	1797	1959	1854	2145	2345	820	950	1038	1151	1330	1453	1464	1689	1843	1792	2065	2251	2134	2469	2699						
<b>29</b>	769	889	972	1041	1202	1312	1320	1522	1660	1615	1861	2029	1920	2222	2429	850	983	1075	1192	1378	1505	1517	1750	1908	1856	2138	2331	2210	2558	2796						
<b>30</b>	795	920	1006	1077	1244	1358	1365	1575	1718	1671	1925	2099	1986	2299	2513	879	1017	1112	1233	1425	1557	1569	1810	1974	1920	2212	2411	2286	2646	2892						
<b>31</b>	822	951	1039	1113	1285	1403	1411	1627	1775	1727	1989	2169	2052	2375	2596	908	1051	1149	1274	1473	1609	1621	1870	2040	1984	2286	2492	2362	2734	2989						
<b>32</b>	848	981	1073	1149	1327	1448	1456	1679	1832	1782	2054	2239	2118	2452	2680	938	1085	1186	1315	1521	1661	1674	1930	2106	2048	2360	2572	2438	2822	3085						
<b>33</b>	875	1012	1106	1185	1368	1493	1502	1732	1889	1838	2118	2309	2185	2529	2764	967	1119	1223	1356	1568	1713	1726	1991	2172	2112	2433	2653	2515	2910	3181						
<b>34</b>	901	1043	1140	1221	1410	1539	1547	1784	1947	1894	2182	2379	2251	2605	2848	996	1153	1260	1397	1616	1765	1778	2051	2237	2176	2507	2733	2591	2999	3278						
<b>35</b>	928	1074	1173	1257	1451	1584	1593	1837	2004	1950	2246	2448	2317	2682	2931	1026	1187	1297	1439	1663	1817	1831	2111	2303	2240	2581	2813	2667	3087	3374						
<b>36</b>	954	1104	1207	1292	1492	1629	1638	1889	2061	2005	2310	2518	2383	2758	3015	1055	1221	1334	1480	1711	1869	1883	2172	2369	2304	2655	2894	2743	3175	3471						
<b>37</b>	981	1135	1240	1328	1534	1674	1684	1942	2118	2061	2375	2588	2449	2835	3099	1084	1255	1372	1521	1758	1920	1935	2232	2435	2368	2728	2974	2819	3263	3567						
<b>38</b>	1007	1166	1274	1364	1575	1720	1729	1994	2176	2117	2439	2658	2516	2912	3183	1113	1289	1409	1562	1806	1972	1987	2292	2501	2432	2802	3054	2896	3351	3663						
<b>39</b>	1034	1196	1308	1400	1617	1765	1775	2047	2233	2172	2503	2728	2582	2988	3266	1143	1323	1446	1603	1853	2024	2040	2353	2566	2496	2876	3135	2972	3440	3760						
<b>40</b>	1060	1227	1341	1436	1658	1810	1820	2099	2290	2228	2567	2798	2648	3065	3350	1172	1356	1483	1644	1901	2076	2092	2413	2632	2560	2950	3215	3048	3528	3856						
<b>41</b>	1087	1258	1375	1472	1700	1855	1866	2152	2347	2284	2631	2868	2714	3141	3434	1201	1390	1520	1685	1948	2128	2144	2473	2698	2624	3023	3296	3124	3616	3953						
<b>42</b>	1113	1288	1408	1508	1741	1901	1911	2204	2405	2339	2695	2938	2780	3218	3518	1231	1424	1557	1726	1996	2180	2197	2534	2764	2688	3097	3376	3200	3704	4049						
<b>43</b>	1140	1319	1442	1544	1783	1946	1957	2257	2462	2395	2760	3008	2847	3295	3601	1260	1458	1594	1767	2043	2232	2249	2594	2830	2752	3171	3456	3277	3792	4145						
<b>44</b>	1166	1350	1475																																	

Heat capacity/technical data per section

**zehnder** *multicolumn klinik*



Overall height = 392–450 mm  $\Phi_L = \Delta T 50 K EN 442$  (SN 384.501-503)

Mod.	K2040			K3040			K4040			K5040			K6040			K2045			K3045			K4045			K5045			K6045		
	T mm	H mm	Exp. n	T mm	H mm	Exp. n	T mm	H mm	Exp. n	T mm	H mm	Exp. n	T mm	H mm	Exp. n	T mm	H mm	Exp. n	T mm	H mm	Exp. n	T mm	H mm	Exp. n	T mm	H mm	Exp. n	T mm	H mm	Exp. n
<b>4</b>	129	150	163	185	214	234	236	273	298	290	334	364	345	399	436	142	164	179	205	237	259	263	304	332	323	372	406	384	445	486
<b>5</b>	162	187	204	232	268	292	296	341	372	362	418	455	431	499	545	177	205	224	257	297	324	329	380	415	404	465	508	481	556	608
<b>6</b>	194	224	245	278	321	351	355	409	447	434	501	547	517	599	654	212	246	269	308	356	389	395	456	498	484	559	609	577	667	729
<b>7</b>	226	262	286	324	375	409	414	478	521	507	585	638	603	698	763	248	287	314	359	415	453	461	532	581	565	652	711	673	779	851
<b>8</b>	258	299	327	370	428	468	473	546	596	579	668	729	690	798	872	283	328	358	410	474	518	526	608	664	646	745	812	769	890	973
<b>9</b>	291	336	368	417	482	526	532	614	670	652	752	820	776	898	982	319	369	403	462	534	583	592	684	746	726	838	914	865	1001	1094
<b>10</b>	323	374	409	463	535	585	591	682	745	724	835	911	862	998	1091	354	410	448	513	593	648	658	760	829	807	931	1015	961	1112	1216
<b>11</b>	355	411	450	509	589	643	650	751	819	796	919	1002	948	1097	1200	389	451	493	564	652	713	724	836	912	888	1024	1117	1057	1224	1337
<b>12</b>	388	449	490	556	642	702	709	819	894	869	1002	1093	1034	1197	1309	425	492	537	616	712	777	790	912	995	968	1117	1218	1153	1335	1459
<b>13</b>	420	486	531	602	696	760	768	887	968	941	1086	1184	1121	1297	1418	460	533	582	667	771	842	855	988	1078	1049	1210	1320	1249	1446	1581
<b>14</b>	452	523	572	648	749	819	827	955	1043	1014	1169	1275	1207	1397	1527	496	574	627	718	830	907	921	1064	1161	1130	1303	1422	1345	1557	1702
<b>15</b>	485	561	613	695	803	877	887	1024	1117	1086	1253	1366	1293	1497	1636	531	615	672	770	890	972	987	1140	1244	1211	1396	1523	1442	1668	1824
<b>16</b>	517	598	654	741	856	936	946	1092	1192	1158	1336	1458	1379	1596	1745	566	656	717	821	949	1037	1053	1216	1327	1291	1489	1625	1538	1780	1945
<b>17</b>	549	636	695	787	910	994	1005	1160	1266	1231	1420	1549	1465	1696	1854	602	697	761	872	1008	1101	1119	1292	1410	1372	1582	1726	1634	1891	2067
<b>18</b>	581	673	736	833	964	1052	1064	1228	1341	1303	1503	1640	1552	1796	1963	637	738	806	923	1068	1166	1184	1368	1493	1453	1676	1828	1730	2002	2188
<b>19</b>	614	710	776	880	1017	1111	1123	1297	1415	1376	1587	1731	1638	1896	2072	673	778	851	975	1127	1231	1250	1444	1576	1533	1769	1929	1826	2113	2310
<b>20</b>	646	748	817	926	1071	1169	1182	1365	1490	1448	1670	1822	1724	1995	2181	708	819	896	1026	1186	1296	1316	1520	1659	1614	1862	2031	1922	2225	2432
<b>21</b>	678	785	858	972	1124	1228	1241	1433	1564	1520	1754	1913	1810	2095	2290	743	860	941	1077	1245	1360	1382	1596	1742	1695	1955	2132	2018	2336	2553
<b>22</b>	711	822	899	1019	1178	1286	1300	1501	1639	1593	1837	2004	1896	2195	2399	779	901	985	1129	1305	1425	1448	1672	1825	1775	2048	2234	2114	2447	2675
<b>23</b>	743	860	940	1065	1231	1345	1359	1570	1713	1665	1921	2095	1983	2295	2508	814	942	1030	1180	1364	1490	1513	1748	1908	1856	2141	2335	2210	2558	2796
<b>24</b>	775	897	981	1111	1285	1403	1418	1638	1788	1738	2004	2186	2069	2394	2617	850	983	1075	1231	1423	1555	1579	1824	1991	1937	2234	2437	2306	2669	2918
<b>25</b>	808	935	1022	1158	1338	1462	1478	1706	1862	1810	2088	2277	2155	2494	2726	885	1024	1120	1283	1483	1620	1645	1900	2074	2018	2327	2539	2403	2781	3040
<b>26</b>	840	972	1062	1204	1392	1520	1537	1774	1937	1882	2171	2369	2241	2594	2835	920	1065	1164	1334	1542	1684	1711	1976	2157	2098	2420	2640	2499	2892	3161
<b>27</b>	872	1009	1103	1250	1445	1579	1596	1843	2011	1955	2255	2460	2327	2694	2945	956	1106	1209	1385	1601	1749	1777	2052	2239	2179	2513	2742	2595	3003	3283
<b>28</b>	904	1047	1144	1296	1499	1637	1655	1911	2086	2027	2338	2551	2414	2794	3054	991	1147	1254	1436	1661	1814	1842	2128	2322	2260	2606	2843	2691	3114	3404
<b>29</b>	937	1084	1185	1343	1552	1696	1714	1979	2160	2100	2422	2642	2500	2893	3163	1027	1188	1299	1488	1720	1879	1908	2204	2405	2340	2700	2945	2787	3226	3526
<b>30</b>	969	1122	1226	1389	1606	1754	1773	2047	2235	2172	2505	2733	2586	2993	3272	1062	1229	1344	1539	1779	1944	1974	2280	2488	2421	2793	3046	2883	3337	3647
<b>31</b>	1001	1159	1267	1435	1659	1813	1832	2116	2309	2244	2589	2824	2672	3093	3381	1097	1270	1388	1590	1839	2008	2040	2356	2571	2502	2886	3148	2979	3448	3769
<b>32</b>	1034	1196	1308	1482	1713	1871	1891	2184	2384	2317	2672	2915	2758	3193	3490	1133	1311	1433	1642	1898	2073	2106	2432	2654	2582	2979	3249	3075	3559	3891
<b>33</b>	1066	1234	1349	1528	1766	1930	1950	2252	2458	2389	2756	3006	2845	3292	3599	1168	1352	1478	1693	1957	2138	2171	2508	2737	2663	3072	3351	3171	3671	4012
<b>34</b>	1098	1271	1389	1574	1820	1988	2009	2320	2533	2462	2839	3097	2931	3392	3708	1204	1393	1523	1744	2016	2203	2237	2584	2820	2744	3165	3452	3267	3782	4134
<b>35</b>	1131	1308	1430	1621	1873	2046	2069	2389	2607	2534	2923	3188	3017	3492	3817	1239	1434	1568	1796	2076	2267	2303	2660	2903	2825	3258	3554	3364	3893	4255
<b>36</b>	1163	1346	1471	1667	1927	2105	2128	2457	2682	2606	3006	3280	3103	3592	3926	1274	1475	1612	1847	2135	2332	2369	2735	2986	2905	3351	3655	3460	4004	4377
<b>37</b>	1195	1383	1512	1713	1981	2163	2187	2525	2756	2679	3090	3371	3189	3691	4035	1310	1516	1657	1898	2194	2397	2435	2811	3069	2986	3444	3757	3556	4115	4499
<b>38</b>	1227	1421	1553	1759	2034	2222	2246	2593	2831	2751	3173	3462	3276	3791	4144	1345	1557	1702	1949	2254	2462	2500	2887	3152	3067	3537	3859	3652	4227	4620
<b>39</b>	1260	1458	1594	1806	2088	2280	2305	2662	2905	2824	3257	3553	3362	3891	4253	1381	1598	1747	2001	2313	2527	2566	2963	3235	3147	3630	3960	3748	4338	4742
<b>40</b>	1292	1495	1635	1852	2141	2339	2364	2730	2980	2896	3341	3644	3448	3991	4362	1416	1639	1791	2052	2372	2591	2632	3039	3318	3228	3723	4062	3844	4449	4863
<b>41</b>	1324	1533	1675	1898	2195	2397	2423	2798	3054	2968	3424	3735	3534	4091	4471	1451	1680	1836	2103	2432	2656	2698	3115	3401	3309	3817	4163	3940	4560	4985
<b>42</b>	1357	1570	1716	1945	2248	2456	2482	2866	3129	3041	3508	3826	3620	4190	4580	1487	1721	1881	2155	2491	2721	2764	3191	3484	3389	3910	4265	4036	4672	5106
<b>43</b>	1389	1608	1757	1991	2302	2514	2541	2935	3203	3113	3591	3917	3707	4290	4689	1522	1762	1926	2206	2550	2786	2829	3267	3567	3470	4003	4366	4132	4783	5228
<b>44</b>	1421	1645	1798	2037	2355	2573	2600																							

Heat capacity/technical data per section

**zehnder** multicolumn klinik

Overall height = 492–550 mm

$\Phi_L = \Delta T$  50 K EN 442 (SN 384.501-503)

Mod.	K2050			K3050			K4050			K5050			K6050			K2055			K3055			K4055			K5055			K6055		
	T mm	H mm	Exp. n	T mm	H mm	Exp. n	T mm	H mm	Exp. n	T mm	H mm	Exp. n	T mm	H mm	Exp. n	T mm	H mm	Exp. n	T mm	H mm	Exp. n	T mm	H mm	Exp. n	T mm	H mm	Exp. n	T mm	H mm	Exp. n
4	154	179	195	225	260	284	290	335	366	356	411	448	424	491	536	168	194	212	245	284	310	317	366	400	389	449	491	464	537	587
5	193	223	244	282	325	355	363	419	457	445	513	560	530	613	671	210	242	265	307	355	388	396	458	500	487	562	613	580	671	734
6	232	268	293	338	391	427	435	502	548	534	616	672	636	736	805	251	291	318	368	426	465	475	549	600	584	674	736	696	806	881
7	270	313	342	394	456	498	508	586	640	623	719	784	742	859	939	293	339	371	429	497	543	554	641	700	681	787	859	812	940	1027
8	309	357	391	450	521	569	580	670	731	712	821	896	848	981	1073	335	388	424	490	568	620	634	733	800	778	899	981	928	1074	1174
9	347	402	440	507	586	640	653	754	823	801	924	1008	954	1104	1207	377	436	477	552	639	698	713	824	900	876	1011	1104	1044	1208	1321
10	386	447	488	563	651	711	725	837	914	890	1027	1120	1060	1227	1341	419	485	530	613	709	776	792	916	1000	973	1124	1227	1160	1343	1468
11	425	491	537	619	716	782	798	921	1005	979	1129	1232	1166	1350	1475	461	533	583	674	780	853	871	1007	1100	1070	1236	1349	1276	1477	1614
12	463	536	586	676	781	853	870	1005	1097	1068	1232	1344	1272	1472	1609	503	582	636	736	851	931	950	1099	1200	1168	1348	1472	1392	1611	1761
13	502	581	635	732	846	924	943	1088	1188	1157	1335	1456	1378	1595	1743	545	630	689	797	922	1008	1030	1190	1300	1265	1461	1594	1508	1745	1908
14	540	625	684	788	911	995	1015	1172	1279	1246	1437	1568	1484	1718	1877	587	679	742	858	993	1086	1109	1282	1400	1362	1573	1717	1624	1880	2055
15	579	670	733	845	976	1066	1088	1256	1371	1335	1540	1680	1590	1840	2012	629	727	795	920	1064	1163	1188	1373	1500	1460	1685	1840	1740	2014	2201
16	618	715	781	901	1041	1138	1160	1340	1462	1424	1643	1792	1696	1963	2146	670	776	848	981	1135	1241	1267	1465	1600	1557	1798	1962	1856	2148	2348
17	656	759	830	957	1107	1209	1233	1423	1554	1513	1745	1904	1802	2086	2280	712	824	901	1042	1206	1318	1346	1557	1700	1654	1910	2085	1972	2282	2495
18	695	804	879	1013	1172	1280	1305	1507	1645	1602	1848	2016	1908	2208	2414	754	873	954	1103	1277	1396	1426	1648	1800	1751	2023	2208	2088	2417	2642
19	733	849	928	1070	1237	1351	1378	1591	1736	1691	1951	2128	2014	2331	2548	796	921	1007	1165	1348	1474	1505	1740	1900	1849	2135	2330	2204	2551	2788
20	772	894	977	1126	1302	1422	1450	1674	1828	1780	2053	2240	2120	2454	2682	838	970	1060	1226	1419	1551	1584	1831	2000	1946	2247	2453	2320	2685	2935
21	811	938	1026	1182	1367	1493	1523	1758	1919	1869	2156	2352	2226	2576	2816	880	1018	1113	1287	1490	1629	1663	1923	2100	2043	2360	2576	2436	2819	3082
22	849	983	1074	1239	1432	1564	1595	1842	2011	1958	2259	2464	2332	2699	2950	922	1067	1166	1349	1561	1706	1742	2014	2200	2141	2472	2698	2552	2954	3229
23	888	1028	1123	1295	1497	1635	1668	1926	2102	2047	2361	2576	2438	2822	3084	964	1115	1219	1410	1632	1784	1822	2106	2300	2238	2584	2821	2668	3088	3375
24	926	1072	1172	1351	1562	1706	1740	2009	2193	2136	2464	2688	2544	2944	3219	1006	1164	1272	1471	1703	1861	1901	2198	2400	2335	2697	2944	2784	3222	3522
25	965	1117	1221	1408	1627	1777	1813	2093	2285	2225	2567	2800	2650	3067	3353	1048	1212	1325	1533	1774	1939	1980	2289	2500	2433	2809	3066	2900	3357	3669
26	1004	1162	1270	1464	1692	1849	1885	2177	2376	2314	2669	2912	2756	3190	3487	1089	1261	1378	1594	1845	2016	2059	2381	2600	2530	2921	3189	3016	3491	3816
27	1042	1206	1319	1520	1757	1920	1958	2261	2468	2403	2772	3024	2862	3313	3621	1131	1309	1431	1655	1916	2094	2138	2472	2700	2627	3034	3312	3132	3625	3962
28	1081	1251	1367	1576	1822	1991	2030	2344	2559	2492	2875	3136	2968	3435	3755	1173	1358	1484	1716	1987	2172	2218	2564	2800	2724	3146	3434	3248	3759	4109
29	1119	1296	1416	1633	1888	2062	2103	2428	2650	2581	2977	3248	3074	3558	3889	1215	1406	1537	1778	2058	2249	2297	2655	2901	2822	3259	3557	3364	3894	4256
30	1158	1340	1465	1689	1953	2133	2175	2512	2742	2670	3080	3360	3180	3681	4023	1257	1455	1590	1839	2128	2327	2376	2747	3001	2919	3371	3680	3480	4028	4403
31	1197	1385	1514	1745	2018	2204	2248	2595	2833	2759	3182	3472	3286	3803	4157	1299	1503	1643	1900	2199	2404	2455	2838	3101	3016	3483	3802	3596	4162	4549
32	1235	1430	1563	1802	2083	2275	2320	2679	2924	2848	3285	3584	3392	3926	4291	1341	1552	1696	1962	2270	2482	2534	2930	3201	3114	3596	3925	3712	4296	4696
33	1274	1474	1612	1858	2148	2346	2393	2763	3016	2937	3388	3695	3498	4049	4426	1383	1600	1749	2023	2341	2559	2614	3022	3301	3211	3708	4048	3828	4431	4843
34	1312	1519	1660	1914	2213	2417	2465	2847	3107	3026	3490	3807	3604	4171	4560	1425	1649	1802	2084	2412	2637	2693	3113	3401	3308	3820	4170	3944	4565	4990
35	1351	1564	1709	1971	2278	2488	2538	2930	3199	3115	3593	3919	3710	4294	4694	1467	1697	1855	2146	2483	2714	2772	3205	3501	3406	3933	4293	4060	4699	5137
36	1390	1608	1758	2027	2343	2560	2610	3014	3290	3204	3696	4031	3816	4417	4828	1508	1746	1908	2207	2554	2792	2851	3296	3601	3503	4045	4415	4176	4833	5283
37	1428	1653	1807	2083	2408	2631	2683	3098	3381	3293	3798	4143	3922	4539	4962	1550	1794	1961	2268	2625	2869	2930	3388	3701	3600	4157	4538	4292	4968	5430
38	1467	1698	1856	2139	2473	2702	2755	3181	3473	3382	3901	4255	4028	4662	5096	1592	1843	2014	2329	2696	2947	3010	3479	3801	3697	4270	4661	4408	5102	5577
39	1505	1742	1905	2196	2538	2773	2828	3265	3564	3471	4004	4367	4134	4785	5230	1634	1891	2067	2391	2767	3025	3089	3571	3901	3795	4382	4783	4524	5236	5724
40	1544	1787	1953	2252	2604	2844	2900	3349	3656	3560	4106	4479	4240	4907	5364	1676	1940	2120	2452	2838	3102	3168	3663	4001	3892	4494	4906	4640	5370	5870
41	1583	1832	2002	2308	2669	2915	2973	3433	3747	3649	4209	4591	4346	5030	5498	1718	1988	2173	2513	2909	3180	3247	3754	4101	3989	4607	5029	4756	5505	6017
42	1621	1876	2051	2365	2734	2986	3045	3516	3838	3738	4312	4703	4452	5153	5632	1760	2037	2226	2575	2980	3257	3326	3846	4201	4087	4719	5151	4872	5639	6164
43	1660	1921	2100	2421	2799	3057	3118	3600	3930	3827	4414	4815	4558	5276	5767	1802	2085	2279	2636	3051	3335	3406	3937	4301	4184	4832	5274	4988	5773	6311
44	1698	1966	2149	2477	2864	3128	3190	3684	4021	3916	4517	4927	4664																	

Heat capacity/technical data per section

**zehnder multicolumn klinik**



Overall height = 592–750 mm  $\Phi_L = \Delta T 50 K EN 442$  (SN 384.501-503)

Mod.	K2060			K3060			K4060			K5060			K6060			K2075			K3075			K4075			K5075			K6075		
	T mm	H mm	Exp. n	T mm	H mm	Exp. n	T mm	H mm	Exp. n	T mm	H mm	Exp. n	T mm	H mm	Exp. n	T mm	H mm	Exp. n	T mm	H mm	Exp. n	T mm	H mm	Exp. n	T mm	H mm	Exp. n	T mm	H mm	Exp. n
4	181	209	229	265	306	335	343	397	433	424	490	534	500	579	633	223	258	282	323	374	409	424	491	536	520	601	657	616	714	781
5	226	262	286	331	383	419	429	496	542	530	612	668	625	723	791	279	323	353	404	468	511	530	613	671	650	751	821	770	892	976
6	271	314	343	397	460	503	515	595	650	636	734	802	750	868	949	335	388	424	484	561	614	636	736	805	780	902	985	924	1071	1171
7	316	366	400	463	536	586	601	694	758	742	857	935	875	1013	1107	391	452	494	565	655	716	742	859	939	910	1052	1149	1078	1249	1366
8	362	419	457	530	613	670	686	794	867	848	979	1069	1000	1157	1265	446	517	565	646	748	818	848	981	1073	1040	1202	1313	1232	1428	1562
9	407	471	515	596	690	754	772	893	975	954	1102	1203	1125	1302	1423	502	581	635	726	842	921	954	1104	1207	1170	1353	1478	1386	1606	1757
10	452	523	572	662	766	838	858	992	1084	1060	1224	1336	1250	1447	1581	558	646	706	807	935	1023	1060	1227	1341	1300	1503	1642	1540	1784	1952
11	497	575	629	728	843	921	944	1091	1192	1166	1346	1470	1375	1591	1740	614	710	777	888	1029	1125	1166	1350	1475	1430	1653	1806	1694	1963	2147
12	542	628	686	794	919	1005	1030	1190	1300	1272	1469	1603	1500	1736	1898	670	775	847	968	1122	1227	1272	1472	1609	1560	1804	1970	1848	2141	2342
13	588	680	743	861	996	1089	1115	1290	1409	1378	1591	1737	1625	1881	2056	725	840	918	1049	1216	1330	1378	1595	1743	1690	1954	2134	2002	2320	2537
14	633	732	801	927	1073	1173	1201	1389	1517	1484	1714	1871	1750	2025	2214	781	904	988	1130	1309	1432	1484	1718	1877	1820	2104	2298	2156	2498	2733
15	678	785	858	993	1149	1256	1287	1488	1625	1590	1836	2004	1875	2170	2372	837	969	1059	1211	1403	1534	1590	1840	2012	1950	2254	2463	2310	2677	2928
16	723	837	915	1059	1226	1340	1373	1587	1734	1696	1959	2138	2000	2315	2530	893	1033	1130	1291	1496	1637	1696	1963	2146	2080	2405	2627	2464	2855	3123
17	768	889	972	1125	1303	1424	1459	1686	1842	1802	2081	2272	2125	2460	2688	949	1098	1200	1372	1590	1739	1802	2086	2280	2210	2555	2791	2618	3034	3318
18	814	942	1029	1192	1379	1508	1544	1785	1950	1908	2203	2405	2250	2604	2847	1004	1163	1271	1453	1683	1841	1908	2208	2414	2340	2705	2955	2772	3212	3513
19	859	994	1087	1258	1456	1591	1630	1885	2059	2014	2326	2539	2375	2749	3005	1060	1227	1341	1533	1777	1943	2014	2331	2548	2470	2856	3119	2926	3390	3709
20	904	1046	1144	1324	1532	1675	1716	1984	2167	2120	2448	2672	2500	2894	3163	1116	1292	1412	1614	1870	2046	2120	2454	2682	2600	3006	3283	3080	3569	3904
21	949	1099	1201	1390	1609	1759	1802	2083	2275	2226	2571	2806	2625	3038	3321	1172	1356	1483	1695	1964	2148	2226	2576	2816	2730	3156	3448	3234	3747	4099
22	994	1151	1258	1456	1686	1843	1888	2182	2384	2332	2693	2940	2750	3183	3479	1228	1421	1553	1775	2057	2250	2332	2699	2950	2860	3306	3612	3388	3926	4294
23	1040	1203	1315	1523	1762	1926	1973	2281	2492	2438	2815	3073	2875	3328	3637	1283	1485	1624	1856	2151	2353	2438	2822	3084	2990	3457	3776	3542	4104	4489
24	1085	1256	1372	1589	1839	2010	2059	2381	2600	2544	2938	3207	3000	3472	3795	1339	1550	1694	1937	2244	2455	2544	2944	3219	3120	3607	3696	4283	4685	
25	1130	1308	1430	1655	1916	2094	2145	2480	2709	2650	3060	3340	3125	3617	3954	1395	1615	1765	2018	2338	2557	2650	3067	3353	3250	3757	4104	3850	4461	4880
26	1175	1360	1487	1721	1992	2178	2231	2579	2817	2756	3183	3474	3250	3762	4112	1451	1679	1835	2098	2431	2659	2756	3190	3487	3380	3908	4268	4004	4640	5075
27	1220	1413	1544	1787	2069	2261	2317	2678	2926	2862	3305	3608	3375	3906	4270	1507	1744	1906	2179	2525	2762	2862	3313	3621	3510	4058	4433	4158	4818	5270
28	1266	1465	1601	1854	2145	2345	2402	2777	3034	2968	3427	3741	3500	4051	4428	1562	1808	1977	2260	2618	2864	2968	3435	3755	3640	4208	4597	4312	4996	5465
29	1311	1517	1658	1920	2222	2429	2488	2877	3142	3074	3550	3875	3625	4196	4586	1618	1873	2047	2340	2712	2966	3074	3558	3889	3770	4359	4761	4466	5175	5660
30	1356	1569	1716	1986	2299	2513	2574	2976	3251	3180	3672	4009	3750	4340	4744	1674	1938	2118	2421	2805	3069	3180	3681	4023	3900	4509	4925	4620	5353	5856
31	1401	1622	1773	2052	2375	2596	2660	3075	3359	3286	3795	4142	3875	4485	4902	1730	2002	2188	2502	2899	3171	3286	3803	4157	4030	4659	5089	4774	5532	6051
32	1446	1674	1830	2118	2452	2680	2746	3174	3467	3392	3917	4276	4000	4630	5061	1786	2067	2259	2582	2992	3273	3392	3926	4291	4160	4809	5253	4928	5710	6246
33	1492	1726	1887	2185	2529	2764	2831	3273	3576	3498	4039	4409	4125	4774	5219	1841	2131	2330	2663	3086	3375	3498	4049	4426	4290	4960	5418	5082	5889	6441
34	1537	1779	1944	2251	2605	2848	2917	3373	3684	3604	4162	4543	4250	4919	5377	1897	2196	2400	2744	3179	3478	3604	4171	4560	4420	5110	5582	5236	6067	6636
35	1582	1831	2001	2317	2682	2931	3003	3472	3792	3710	4284	4677	4375	5064	5535	1953	2260	2471	2825	3273	3580	3710	4294	4694	4550	5260	5746	5390	6246	6832
36	1627	1883	2059	2383	2758	3015	3089	3571	3901	3816	4407	4810	4500	5208	5693	2009	2325	2541	2905	3366	3682	3816	4417	4828	4680	5411	5910	5544	6424	7027
37	1672	1936	2116	2449	2835	3099	3175	3670	4009	3922	4529	4944	4625	5353	5851	2065	2390	2612	2986	3460	3785	3922	4539	4962	4810	5561	6074	5698	6602	7222
38	1718	1988	2173	2516	2912	3183	3260	3769	4117	4028	4652	5077	4750	5498	6009	2120	2454	2683	3067	3553	3887	4028	4662	5096	4940	5711	6238	5852	6781	7417
39	1763	2040	2230	2582	2988	3266	3346	3869	4226	4134	4774	5211	4875	5642	6168	2176	2519	2753	3147	3647	3989	4134	4785	5230	5070	5861	6403	6006	6959	7612
40	1808	2093	2287	2648	3065	3350	3432	3968	4334	4240	4896	5345	5000	5787	6326	2232	2583	2824	3228	3740	4091	4240	4907	5364	5200	6012	6567	6160	7138	7808
41	1853	2145	2345	2714	3141	3434	3518	4067	4442	4346	5019	5478	5125	5932	6484	2288	2648	2894	3309	3834	4194	4346	5030	5498						
42	1898	2197	2402	2780	3218	3518	3604	4166	4551	4452	5141	5612	5250	6076	6642	2344	2713	2965	3389	3927	4296	4452	5153	5632						
43	1944	2250	2459	2847	3295	3601	3689	4265	4659	4558	5264	5746	5375	6221	6800	2399	2777	3036	3470	4021	4398	4558	5276	5767						
44	1989	2302	2516	2913	3371	3685	3775	4365	4768	4664	5386	5879	5500	6366	6958	2455	2842	3106	3551	4114	4501	4664	5398	5901						
45	2034	2354	2573	2979	3448	3769	3861	4464	4876	4770	5508	6013	5625	6510	7116	2511	2906	3177	3632	4208	4603	4770	5521	6035						
46	2079	2407	2631	3045	3525	3853	3947	4563	4984	4876	5631	6146	5750	6655	7275	2567	2971	3247	3712	4301	4705									

**Conversion factors f<sub>1</sub> for ΔT temperature differences other than 50 K (EN 442)**

$$f_1 = \left(\frac{\Delta T}{50}\right)^n$$

ΔT K \ n	n														
	1,16	1,17	1,18	1,19	1,20	1,21	1,22	1,23	1,24	1,25	1,26	1,27	1,28	1,29	1,30
10	0,1546	0,1521	0,1497	0,1473	0,1450	0,1426	0,1404	0,1381	0,1359	0,1337	0,1316	0,1295	0,1274	0,1254	0,1234
11	0,1727	0,1701	0,1675	0,1650	0,1625	0,1601	0,1577	0,1553	0,1530	0,1507	0,1484	0,1462	0,1440	0,1418	0,1397
12	0,1910	0,1883	0,1856	0,1830	0,1804	0,1779	0,1753	0,1728	0,1704	0,1680	0,1656	0,1633	0,1609	0,1587	0,1564
13	0,2096	0,2068	0,2040	0,2013	0,1986	0,1959	0,1933	0,1907	0,1882	0,1857	0,1832	0,1807	0,1783	0,1759	0,1736
14	0,2284	0,2255	0,2227	0,2198	0,2171	0,2143	0,2116	0,2089	0,2063	0,2037	0,2011	0,1986	0,1960	0,1936	0,1911
15	0,2474	0,2445	0,2415	0,2387	0,2358	0,2330	0,2302	0,2274	0,2247	0,2220	0,2194	0,2167	0,2141	0,2116	0,2091
16	0,2667	0,2636	0,2607	0,2577	0,2548	0,2519	0,2490	0,2462	0,2434	0,2407	0,2380	0,2353	0,2326	0,2300	0,2274
17	0,2861	0,2830	0,2800	0,2770	0,2740	0,2711	0,2682	0,2653	0,2624	0,2596	0,2568	0,2541	0,2514	0,2487	0,2460
18	0,3057	0,3026	0,2995	0,2965	0,2935	0,2905	0,2875	0,2846	0,2817	0,2789	0,2760	0,2732	0,2704	0,2677	0,2650
19	0,3255	0,3224	0,3193	0,3162	0,3131	0,3101	0,3071	0,3042	0,3013	0,2984	0,2955	0,2926	0,2898	0,2870	0,2843
20	0,3455	0,3423	0,3392	0,3361	0,3330	0,3300	0,3270	0,3240	0,3210	0,3181	0,3152	0,3123	0,3095	0,3067	0,3039
21	0,3656	0,3624	0,3593	0,3562	0,3531	0,3501	0,3470	0,3440	0,3411	0,3381	0,3352	0,3323	0,3294	0,3266	0,3238
22	0,3858	0,3827	0,3796	0,3765	0,3734	0,3703	0,3673	0,3643	0,3613	0,3584	0,3554	0,3525	0,3496	0,3468	0,3439
23	0,4063	0,4031	0,4000	0,3969	0,3938	0,3908	0,3878	0,3848	0,3818	0,3788	0,3759	0,3730	0,3701	0,3672	0,3644
24	0,4268	0,4237	0,4206	0,4175	0,4145	0,4114	0,4084	0,4054	0,4025	0,3995	0,3966	0,3937	0,3908	0,3880	0,3851
25	0,4475	0,4444	0,4414	0,4383	0,4353	0,4323	0,4293	0,4263	0,4234	0,4204	0,4175	0,4147	0,4118	0,4090	0,4061
26	0,4683	0,4653	0,4623	0,4592	0,4563	0,4533	0,4503	0,4474	0,4445	0,4416	0,4387	0,4358	0,4330	0,4302	0,4274
27	0,4893	0,4863	0,4833	0,4803	0,4774	0,4745	0,4715	0,4686	0,4658	0,4629	0,4601	0,4572	0,4544	0,4516	0,4489
28	0,5104	0,5074	0,5045	0,5016	0,4987	0,4958	0,4929	0,4901	0,4873	0,4844	0,4816	0,4788	0,4761	0,4733	0,4706
29	0,5316	0,5287	0,5258	0,5230	0,5201	0,5173	0,5145	0,5117	0,5089	0,5062	0,5034	0,5007	0,4980	0,4952	0,4926
30	0,5529	0,5501	0,5473	0,5445	0,5417	0,5390	0,5362	0,5335	0,5308	0,5281	0,5254	0,5227	0,5200	0,5174	0,5148
31	0,5743	0,5716	0,5689	0,5662	0,5635	0,5608	0,5581	0,5554	0,5528	0,5502	0,5475	0,5449	0,5423	0,5397	0,5372
32	0,5959	0,5932	0,5906	0,5880	0,5854	0,5827	0,5801	0,5776	0,5750	0,5724	0,5699	0,5673	0,5648	0,5623	0,5598
33	0,6175	0,6150	0,6124	0,6099	0,6074	0,6049	0,6023	0,5998	0,5974	0,5949	0,5924	0,5900	0,5875	0,5851	0,5826
34	0,6393	0,6368	0,6344	0,6320	0,6295	0,6271	0,6247	0,6223	0,6199	0,6175	0,6151	0,6128	0,6104	0,6080	0,6057
35	0,6612	0,6588	0,6565	0,6541	0,6518	0,6495	0,6472	0,6449	0,6426	0,6403	0,6380	0,6357	0,6335	0,6312	0,6290
36	0,6831	0,6809	0,6787	0,6764	0,6742	0,6720	0,6698	0,6676	0,6654	0,6632	0,6611	0,6589	0,6567	0,6546	0,6524
37	0,7052	0,7031	0,7010	0,6989	0,6968	0,6947	0,6926	0,6905	0,6884	0,6863	0,6843	0,6822	0,6802	0,6781	0,6761
38	0,7274	0,7254	0,7234	0,7214	0,7194	0,7174	0,7155	0,7135	0,7116	0,7096	0,7077	0,7057	0,7038	0,7019	0,6999
39	0,7496	0,7477	0,7459	0,7440	0,7422	0,7403	0,7385	0,7367	0,7348	0,7330	0,7312	0,7294	0,7276	0,7258	0,7240
40	0,7719	0,7702	0,7685	0,7668	0,7651	0,7634	0,7617	0,7600	0,7583	0,7566	0,7549	0,7532	0,7515	0,7499	0,7482
41	0,7944	0,7928	0,7912	0,7897	0,7881	0,7865	0,7850	0,7834	0,7819	0,7803	0,7788	0,7772	0,7757	0,7741	0,7726
42	0,8169	0,8155	0,8140	0,8126	0,8112	0,8098	0,8084	0,8070	0,8056	0,8042	0,8028	0,8014	0,8000	0,7986	0,7972
43	0,8395	0,8382	0,8370	0,8357	0,8344	0,8332	0,8319	0,8307	0,8294	0,8282	0,8269	0,8257	0,8244	0,8232	0,8220
44	0,8622	0,8611	0,8600	0,8589	0,8578	0,8567	0,8556	0,8545	0,8534	0,8523	0,8512	0,8501	0,8491	0,8480	0,8469
45	0,8850	0,8840	0,8831	0,8822	0,8812	0,8803	0,8794	0,8785	0,8775	0,8766	0,8757	0,8748	0,8738	0,8729	0,8720
46	0,9078	0,9071	0,9063	0,9055	0,9048	0,9040	0,9033	0,9025	0,9018	0,9010	0,9003	0,8995	0,8988	0,8980	0,8973
47	0,9307	0,9302	0,9296	0,9290	0,9284	0,9279	0,9273	0,9267	0,9261	0,9256	0,9250	0,9244	0,9239	0,9233	0,9227
48	0,9538	0,9534	0,9530	0,9526	0,9522	0,9518	0,9514	0,9510	0,9506	0,9503	0,9499	0,9495	0,9491	0,9487	0,9483
49	0,9768	0,9766	0,9764	0,9762	0,9760	0,9759	0,9757	0,9755	0,9753	0,9751	0,9749	0,9747	0,9745	0,9743	0,9741
50	1,0000	1,0000	1,0000	1,0000	1,0000	1,0000	1,0000	1,0000	1,0000	1,0000	1,0000	1,0000	1,0000	1,0000	1,0000
51	1,0232	1,0234	1,0236	1,0238	1,0240	1,0243	1,0245	1,0247	1,0249	1,0251	1,0253	1,0255	1,0257	1,0259	1,0261
52	1,0465	1,0470	1,0474	1,0478	1,0482	1,0486	1,0490	1,0494	1,0498	1,0502	1,0507	1,0511	1,0515	1,0519	1,0523
53	1,0699	1,0706	1,0712	1,0718	1,0724	1,0731	1,0737	1,0743	1,0749	1,0756	1,0762	1,0768	1,0774	1,0781	1,0787
54	1,0934	1,0942	1,0951	1,0959	1,0968	1,0976	1,0984	1,0993	1,1001	1,1010	1,1018	1,1027	1,1035	1,1044	1,1052
55	1,1169	1,1180	1,1190	1,1201	1,1212	1,1222	1,1233	1,1244	1,1255	1,1265	1,1276	1,1287	1,1298	1,1308	1,1319
56	1,1405	1,1418	1,1431	1,1444	1,1457	1,1470	1,1483	1,1496	1,1509	1,1522	1,1535	1,1548	1,1561	1,1574	1,1587
57	1,1642	1,1657	1,1672	1,1687	1,1703	1,1718	1,1733	1,1749	1,1764	1,1780	1,1795	1,1811	1,1826	1,1842	1,1857
58	1,1879	1,1896	1,1914	1,1932	1,1949	1,1967	1,1985	1,2003	1,2021	1,2039	1,2056	1,2074	1,2092	1,2110	1,2128
59	1,2117	1,2137	1,2157	1,2177	1,2197	1,2217	1,2238	1,2258	1,2278	1,2299	1,2319	1,2339	1,2360	1,2380	1,2401
60	1,2355	1,2378	1,2400	1,2423	1,2446	1,2468	1,2491	1,2514	1,2537	1,2560	1,2583	1,2606	1,2629	1,2652	1,2675
61	1,2594	1,2619	1,2645	1,2670	1,2695	1,2720	1,2746	1,2771	1,2796	1,2822	1,2847	1,2873	1,2899	1,2924	1,2950
62	1,2834	1,2862	1,2890	1,2917	1,2945	1,2973	1,3001	1,3029	1,3057	1,3085	1,3113	1,3142	1,3170	1,3198	1,3227
63	1,3075	1,3105	1,3135	1,3166	1,3196	1,3227	1,3257	1,3288	1,3319	1,3349	1,3380	1,3411	1,3442	1,3473	1,3505
64	1,3316	1,3349	1,3382	1,3415	1,3448	1,3481	1,3514	1,3548	1,3581	1,3615	1,3648	1,3682	1,3716	1,3750	1,3784
65	1,3557	1,3593	1,3629	1,3664	1,3700	1,3736	1,3772	1,3809	1,3845	1,3881	1,3918	1,3954	1,3991	1,4028	1,4065
66	1,3800	1,3838	1,3876	1,3915	1,3954	1,3992	1,4031	1,4070	1,4110	1,4149	1,4188	1,4228	1,4267	1,4307	1,4347
67	1,4042	1,4084	1,4125	1,4166	1,4208	1,4249	1,4291	1,4333	1,4375	1,4417	1,4459	1,4502	1,4544	1,4587	1,4630
68	1,4286	1,4330	1,4374	1,4418	1,4463	1,4507	1,4552	1,4597	1,4642	1,4687	1,4732	1,4777	1,4823	1,4868	1,4914
69	1,4530	1,4577	1,4624	1,4671	1,4718	1,4766	1,4813	1,4861	1,4909	1,4957	1,5005	1,5054	1,5102	1,5151	1,5200
70	1,4774	1,4824	1,4874	1,4924	1,4975	1,5025	1,5076	1,5126	1,5177	1,5229	1,5280	1,5331	1,5383	1,5435	1,5487

1,31	1,32	1,33	1,34	1,35	1,36	1,37	1,38	1,39	1,40	1,41	1,42	1,43	1,44	1,45	n	ΔT K
0,1214	0,1195	0,1176	0,1157	0,1139	0,1120	0,1103	0,1085	0,1068	0,1051	0,1034	0,1017	0,1001	0,0985	0,0969	10	
0,1376	0,1355	0,1335	0,1315	0,1295	0,1276	0,1256	0,1237	0,1219	0,1201	0,1183	0,1165	0,1147	0,1130	0,1113	11	
0,1542	0,1520	0,1499	0,1477	0,1456	0,1436	0,1415	0,1395	0,1376	0,1356	0,1337	0,1318	0,1299	0,1281	0,1263	12	
0,1712	0,1690	0,1667	0,1645	0,1623	0,1601	0,1579	0,1558	0,1537	0,1517	0,1497	0,1477	0,1457	0,1437	0,1418	13	
0,1887	0,1863	0,1840	0,1816	0,1793	0,1771	0,1748	0,1726	0,1704	0,1683	0,1661	0,1640	0,1620	0,1599	0,1579	14	
0,2066	0,2041	0,2016	0,1992	0,1968	0,1945	0,1922	0,1899	0,1876	0,1853	0,1831	0,1809	0,1788	0,1766	0,1745	15	
0,2248	0,2222	0,2197	0,2172	0,2148	0,2123	0,2099	0,2075	0,2052	0,2029	0,2006	0,1983	0,1960	0,1938	0,1916	16	
0,2434	0,2407	0,2382	0,2356	0,2331	0,2306	0,2281	0,2257	0,2232	0,2208	0,2185	0,2161	0,2138	0,2115	0,2092	17	
0,2623	0,2596	0,2570	0,2544	0,2518	0,2492	0,2467	0,2442	0,2417	0,2392	0,2368	0,2344	0,2320	0,2297	0,2273	18	
0,2815	0,2788	0,2761	0,2735	0,2708	0,2682	0,2656	0,2631	0,2606	0,2580	0,2556	0,2531	0,2507	0,2482	0,2459	19	
0,3011	0,2983	0,2956	0,2929	0,2903	0,2876	0,2850	0,2824	0,2798	0,2773	0,2747	0,2722	0,2697	0,2673	0,2648	20	
0,3210	0,3182	0,3154	0,3127	0,3100	0,3073	0,3047	0,3021	0,2994	0,2969	0,2943	0,2918	0,2892	0,2867	0,2843	21	
0,3411	0,3383	0,3356	0,3328	0,3301	0,3274	0,3247	0,3221	0,3194	0,3168	0,3142	0,3117	0,3091	0,3066	0,3041	22	
0,3616	0,3588	0,3560	0,3533	0,3505	0,3478	0,3451	0,3425	0,3398	0,3372	0,3346	0,3320	0,3294	0,3269	0,3243	23	
0,3823	0,3795	0,3767	0,3740	0,3713	0,3685	0,3658	0,3632	0,3605	0,3579	0,3553	0,3527	0,3501	0,3475	0,3450	24	
0,4033	0,4005	0,3978	0,3950	0,3923	0,3896	0,3869	0,3842	0,3816	0,3789	0,3763	0,3737	0,3711	0,3686	0,3660	25	
0,4246	0,4218	0,4191	0,4163	0,4136	0,4109	0,4082	0,4056	0,4029	0,4003	0,3977	0,3951	0,3925	0,3900	0,3874	26	
0,4461	0,4434	0,4406	0,4379	0,4352	0,4326	0,4299	0,4273	0,4246	0,4220	0,4194	0,4169	0,4143	0,4118	0,4092	27	
0,4679	0,4652	0,4625	0,4598	0,4571	0,4545	0,4519	0,4493	0,4467	0,4441	0,4415	0,4390	0,4364	0,4339	0,4314	28	
0,4899	0,4872	0,4846	0,4819	0,4793	0,4767	0,4741	0,4716	0,4690	0,4664	0,4639	0,4614	0,4589	0,4564	0,4539	29	
0,5121	0,5095	0,5069	0,5043	0,5018	0,4992	0,4967	0,4941	0,4916	0,4891	0,4866	0,4841	0,4817	0,4792	0,4768	30	
0,5346	0,5321	0,5295	0,5270	0,5245	0,5220	0,5195	0,5170	0,5145	0,5121	0,5097	0,5072	0,5048	0,5024	0,5000	31	
0,5573	0,5548	0,5524	0,5499	0,5474	0,5450	0,5426	0,5402	0,5378	0,5354	0,5330	0,5306	0,5282	0,5259	0,5236	32	
0,5802	0,5778	0,5754	0,5730	0,5707	0,5683	0,5659	0,5636	0,5613	0,5589	0,5566	0,5543	0,5520	0,5497	0,5474	33	
0,6034	0,6011	0,5987	0,5964	0,5941	0,5919	0,5896	0,5873	0,5850	0,5828	0,5805	0,5783	0,5761	0,5739	0,5717	34	
0,6267	0,6245	0,6223	0,6201	0,6178	0,6156	0,6135	0,6113	0,6091	0,6069	0,6048	0,6026	0,6005	0,5983	0,5962	35	
0,6503	0,6482	0,6460	0,6439	0,6418	0,6397	0,6376	0,6355	0,6334	0,6313	0,6293	0,6272	0,6252	0,6231	0,6211	36	
0,6741	0,6720	0,6700	0,6680	0,6660	0,6640	0,6620	0,6600	0,6580	0,6560	0,6541	0,6521	0,6501	0,6482	0,6462	37	
0,6980	0,6961	0,6942	0,6923	0,6904	0,6885	0,6866	0,6847	0,6829	0,6810	0,6791	0,6773	0,6754	0,6736	0,6717	38	
0,7222	0,7204	0,7186	0,7168	0,7150	0,7133	0,7115	0,7097	0,7080	0,7062	0,7045	0,7027	0,7010	0,6992	0,6975	39	
0,7465	0,7449	0,7432	0,7416	0,7399	0,7382	0,7366	0,7350	0,7333	0,7317	0,7301	0,7284	0,7268	0,7252	0,7236	40	
0,7711	0,7695	0,7680	0,7665	0,7650	0,7635	0,7619	0,7604	0,7589	0,7574	0,7559	0,7544	0,7529	0,7514	0,7499	41	
0,7958	0,7944	0,7930	0,7917	0,7903	0,7889	0,7875	0,7861	0,7848	0,7834	0,7820	0,7807	0,7793	0,7780	0,7766	42	
0,8207	0,8195	0,8182	0,8170	0,8158	0,8146	0,8133	0,8121	0,8109	0,8097	0,8084	0,8072	0,8060	0,8048	0,8036	43	
0,8458	0,8447	0,8436	0,8426	0,8415	0,8404	0,8393	0,8383	0,8372	0,8361	0,8351	0,8340	0,8329	0,8319	0,8308	44	
0,8711	0,8702	0,8692	0,8683	0,8674	0,8665	0,8656	0,8647	0,8638	0,8629	0,8619	0,8610	0,8601	0,8592	0,8583	45	
0,8965	0,8958	0,8950	0,8943	0,8935	0,8928	0,8921	0,8913	0,8906	0,8898	0,8891	0,8883	0,8876	0,8869	0,8861	46	
0,9221	0,9216	0,9210	0,9204	0,9199	0,9193	0,9187	0,9182	0,9176	0,9170	0,9165	0,9159	0,9153	0,9148	0,9142	47	
0,9479	0,9475	0,9472	0,9468	0,9464	0,9460	0,9456	0,9452	0,9448	0,9445	0,9441	0,9437	0,9433	0,9429	0,9425	48	
0,9739	0,9737	0,9735	0,9733	0,9731	0,9729	0,9727	0,9725	0,9723	0,9721	0,9719	0,9717	0,9715	0,9713	0,9711	49	
1,0000	1,0000	1,0000	1,0000	1,0000	1,0000	1,0000	1,0000	1,0000	1,0000	1,0000	1,0000	1,0000	1,0000	1,0000	50	
1,0263	1,0265	1,0267	1,0269	1,0271	1,0273	1,0275	1,0277	1,0279	1,0281	1,0283	1,0285	1,0287	1,0289	1,0291	51	
1,0527	1,0531	1,0535	1,0540	1,0544	1,0548	1,0552	1,0556	1,0560	1,0564	1,0569	1,0573	1,0577	1,0581	1,0585	52	
1,0793	1,0800	1,0806	1,0812	1,0818	1,0825	1,0831	1,0837	1,0844	1,0850	1,0856	1,0863	1,0869	1,0875	1,0882	53	
1,1061	1,1069	1,1078	1,1086	1,1095	1,1103	1,1112	1,1121	1,1129	1,1138	1,1146	1,1155	1,1163	1,1172	1,1181	54	
1,1330	1,1341	1,1351	1,1362	1,1373	1,1384	1,1395	1,1406	1,1417	1,1427	1,1438	1,1449	1,1460	1,1471	1,1482	55	
1,1600	1,1614	1,1627	1,1640	1,1653	1,1666	1,1680	1,1693	1,1706	1,1719	1,1733	1,1746	1,1759	1,1773	1,1786	56	
1,1873	1,1888	1,1904	1,1919	1,1935	1,1951	1,1966	1,1982	1,1998	1,2013	1,2029	1,2045	1,2061	1,2077	1,2092	57	
1,2146	1,2164	1,2182	1,2200	1,2219	1,2237	1,2255	1,2273	1,2291	1,2310	1,2328	1,2346	1,2364	1,2383	1,2401	58	
1,2421	1,2442	1,2462	1,2483	1,2504	1,2524	1,2545	1,2566	1,2587	1,2608	1,2629	1,2649	1,2670	1,2691	1,2712	59	
1,2698	1,2721	1,2744	1,2767	1,2791	1,2814	1,2837	1,2861	1,2884	1,2908	1,2931	1,2955	1,2979	1,3002	1,3026	60	
1,2976	1,3002	1,3027	1,3053	1,3079	1,3105	1,3131	1,3158	1,3184	1,3210	1,3236	1,3263	1,3289	1,3316	1,3342	61	
1,3255	1,3284	1,3312	1,3341	1,3370	1,3398	1,3427	1,3456	1,3485	1,3514	1,3543	1,3572	1,3602	1,3631	1,3660	62	
1,3536	1,3567	1,3599	1,3630	1,3662	1,3693	1,3725	1,3757	1,3788	1,3820	1,3852	1,3884	1,3916	1,3949	1,3981	63	
1,3818	1,3852	1,3886	1,3921	1,3955	1,3990	1,4024	1,4059	1,4094	1,4128	1,4163	1,4198	1,4233	1,4269	1,4304	64	
1,4102	1,4139	1,4176	1,4213	1,4250	1,4288	1,4325	1,4363	1,4401	1,4438	1,4476	1,4514	1,4553	1,4591	1,4629	65	
1,4386	1,4426	1,4466	1,4507	1,4547	1,4587	1,4628	1,4669	1,4709	1,4750	1,4791	1,4833	1,4874	1,4915	1,4957	66	
1,4673	1,4716	1,4759	1,4802	1,4845	1,4889	1,4933	1,4976	1,5020	1,5064	1,5108	1,5153	1,5197	1,5242	1,5286	67	
1,4960	1,5006	1,5052	1,5099	1,5145	1,5192	1,5239	1,5286	1,5333	1,5380	1,5427	1,5475	1,5522	1,5570	1,5618	68	
1,5249	1,5298	1,5348	1,5397	1,5447	1,5497	1,5547	1,5597	1,5647	1,5698	1,5748	1,5799	1,5850	1,5901	1,5952	69	
1,5539	1,5592	1,5644	1,5697	1,5750	1,5803	1,5856	1,5910	1,5963	1,6017	1,6071	1,6125	1,6179	1,6234	1,6289	70	

Configuration examples

**zehnder** *multicolumn*, *multicolumn completo*,  
*multicolumn klinik*

**zehnder**

The **zehnder** *multicolumn* radiators are particularly versatile.  
Call us and we shall be pleased to advise you.

Curved version in front of window



Special circular application



**zehnder** *multicolumn*



**zehnder** *multicolumn*



For more information on Zehnder go to [www.barbourproductsearch.info](http://www.barbourproductsearch.info)

For more information on Zehnder go to [www.barbourproductsearch.info](http://www.barbourproductsearch.info)

Zehnder Ltd  
B15 Armstrong Mall  
Southwood Business Park  
Farnborough, Hants. GU14 0NR

Tel. +44 (0) 1252 515151  
Fax +44 (0) 1252 522528  
[sales@zehnder.co.uk](mailto:sales@zehnder.co.uk)  
[www.zehnder.co.uk](http://www.zehnder.co.uk)

**zehnder**

© Zehnder Ltd, Farnborough, June 2003