

ECOPHON AKUSTO™ TRIANGLE

Ecophon Akusto™ Triangle is a triangle shaped wall panel, offering possibility for endless wall patterns. Mounting the panel onto a wall is easy. Use glue for quick direct fix or use Connect One Trim that has two different distance choices enabling 3-dimensional patterns.



Ecophon Akusto™ Triangle

SYSTEM RANGE



Size, mm	513x592
Special Fixing	•
Thickness	40
Inst. Diagr.	M585



Akusto Triangle panel



Installation with Connect™ One trim and Connect™ Absorber Anchor One



Installation with Connect™ One hook fixing

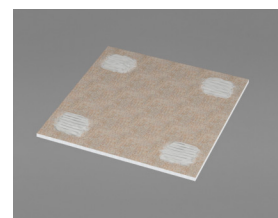

Installation with Connect™ Absorber glue



ACOUSTIC

The values in the diagram refer to a single unit.

Sound Absorption

Based on test results according to EN ISO 354.

A_{eq} , Equivalent absorption area per unit (m^2 sabin)

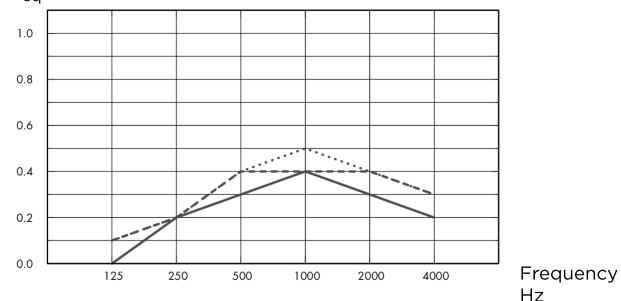

- Akusto Triangle, 43 mm o.d.s
 - Akusto Triangle, 48 mm o.d.s
 - Akusto Triangle, 70 mm o.d.s
- o.d.s = overall depth of system

THK mm	o.d.s. mm	A_{eq} , Equivalent absorption area per unit (m^2 sabin)					
		125 Hz	250 Hz	500 Hz	1000 Hz	2000 Hz	4000 Hz
40	43	0.0	0.2	0.3	0.4	0.3	0.2
40	48	0.1	0.2	0.4	0.4	0.4	0.3
40	70	0.1	0.2	0.4	0.5	0.4	0.3



INDOOR AIR QUALITY

Certificate / Label	Akutex FT White Frost	
Eurofins Indoor Air Comfort®	IAC Gold	IAC
French VOC	A+	A+



CRADLE TO CRADLE CERTIFIED®

Akusto products with Akutex FT surface are Cradle to Cradle Certified® at Bronze level (version 4.0).





MATERIAL HEALTH

Akusto products with Akutex FT surface have received a C2C Certified Material Health Certificate™ at the Silver level (standard version 4.0). The C2C Certified Material Health Certificate™ is a verification of the health and safety of a product's composition using the Material Health requirements of the Cradle-to-Cradle Certified Product Standard.



CARBON FOOTPRINT

Life-cycle stages A1 to C4 from EPD, in conformity with ISO 14025 / EN 15804

	kg CO ₂ equiv/m ²
Akusto Triangle	1,06



CIRCULARITY

Minimum post-consumer recycled content	60%
Recyclability	Fully recyclable



FIRE SAFETY

The glass wool core of the tiles is tested and classified as non-combustible according to EN ISO 1182.

Country	Fire standard	Class
Europe	EN 13501-1	A2-s1,d0



HUMIDITY RESISTANCE

Class C, relative humidity 95% and 30°C, according to EN 13964:2014



VISUAL APPEARANCE

Akusto Wall in white has high light reflectance. Light reflectance and nearest NCS colour sample for all the different colours: See Ecophon Colours and surfaces.



CLEANABILITY

Akutex FT: Daily dusting and vacuum cleaning. Weekly wet wiping. Advantage surface, weekly dusting and vacuum cleaning. For more info see colours and surfaces on www.ecophon.com/uk



ACCESSIBILITY

The tiles are easily demountable except glued installation see quantity specification.



INSTALLATION

Installed according to installation diagrams, installation guides and drawing aid. For information regarding minimum overall depth of system see quantity specification. Rendered surfaces must have sufficient strength to be able to carry the load imposed by the tiles. If doubts, test gluing should be carried out. The surface should always be dry and clean. For best result the surface should be even, however an acceptable result could be achieved on slightly uneven surfaces.



PACKAGING INFORMATION

Information is indicative and subject to change.

	Panels / crt
1039x1200x40	2



SYSTEM WEIGHT

Weight information is indicative and subject to variation.

	kg/m ²
Akusto Triangle	3,5



MECHANICAL PROPERTIES

No additional live load is allowed.



CE

Ecophon ceiling systems are CE marked according to the European harmonized standard EN13964:2014. CE marked construction products are covered by a Declaration of Performance (DOP) which enables customers and users to easily compare performance of products available on the European market.

COLOURS AND DESIGN

Akutex™ FT

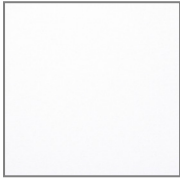

White Frost



Deep Sea



Sage Mist



Morning Rain



Scallop Shells



Spring Leaf



Pine Green

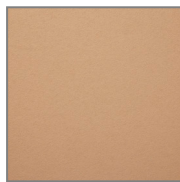

Wet Sand



Silent Steam

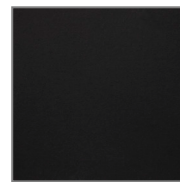

Dark Diamond



Cloudy Day



Volcanic Ash



Silver Stone

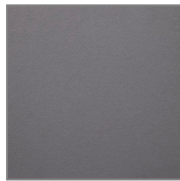

Silk Slate

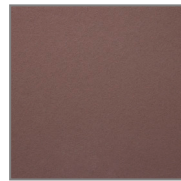

Dark Chestnut

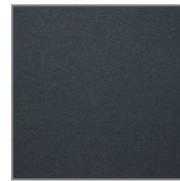

Basalt Rock

Wall installation

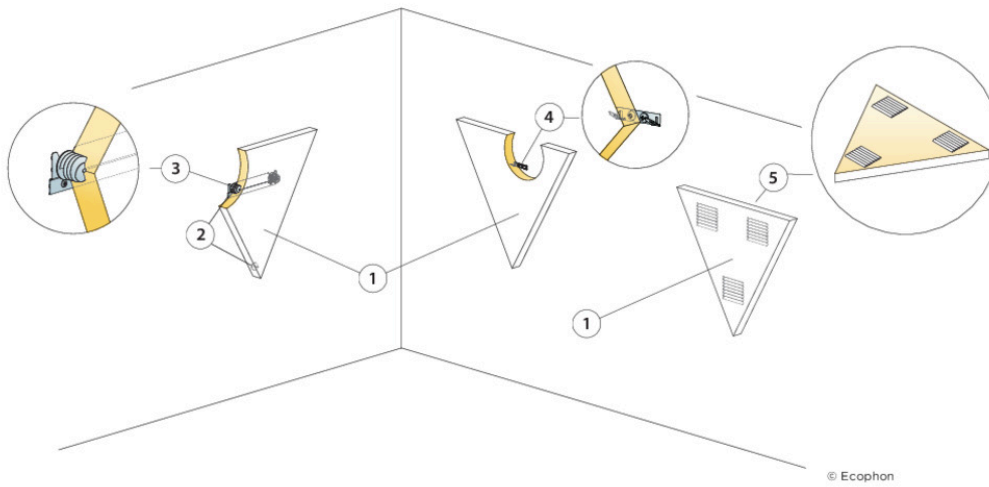

Installation diagram (M585) for Ecophon Akusto Triangle

Quantity specification (excl. wastage)

	Size, mm
	513x592
1 Akusto Triangle	3,2/m ²
2 Alt. 1 Connect One trim (wall distance included)	0,5/panel
3 Alt. 1 Connect Absorber Anchor One	2/panel
4 Alt. 2 Connect One hook fixing	2/panel
5 Alt. 3 Connect Absorber glue (0,25 l/m ² - 0,4 l/m ² depending on installation conditions)	as required
Use Connect Notched spatula to apply the glue.	
Δ Min. overall depth of system: Δ1 48 mm/70mm / Δ2 44 mm The system is demountable	
Δ Min. overall depth of system: Δ3 43 mm. The system is not demountable	

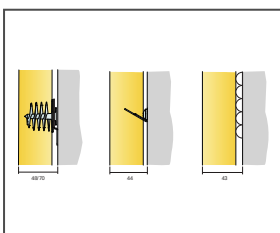

See Quantity specification

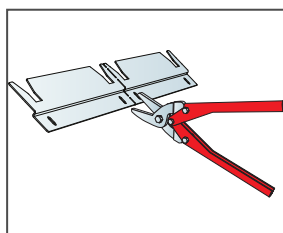

Connect One trim can be divided into two suspension trims

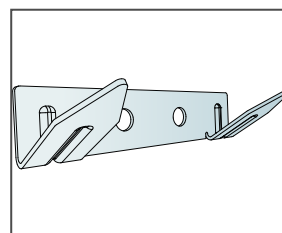

Connect One hook fixing

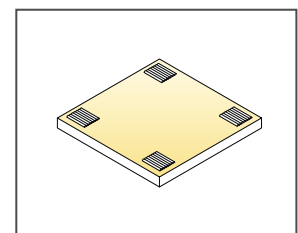

Application of glue