

# ECOPHON AKUSTO™ WALL EDGE A

Ecophon Akusto™ Wall A has an exposed profile system with a variety of surface options. This wall absorber pairs with a sound absorbing ceiling to achieve excellent acoustic properties in the room.



# Ecophon Akusto™ Wall Edge A

## SYSTEM RANGE



Size, mm	2700x1200
Channel trim	•
Thinline Profile	•
Thickness	40
Inst. Diagr.	M353, M504, M593, M595



Akusto Wall A



Akusto Wall A system with Connect Channel trim and Connect T24 Main runner

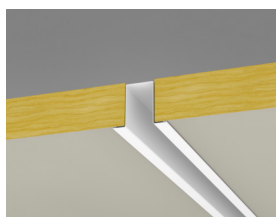

Akusto Wall A system with Connect Channel trim and Connect Recessed profile



## TYPE OF APPLICATION

- Office
- Education
- Healthcare
- Additional areas



## ACOUSTIC

### Sound Absorption

Test results according to EN ISO 354. Classification according to EN ISO 11654, and the single value ratings for Noise Reduction Coefficient, NRC and Sound Absorption Average, SAA according to ASTM C 423.

$\alpha_p$ , Practical sound absorption coefficient

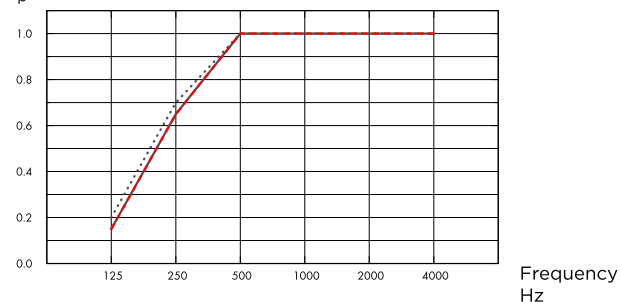

- Akusto Wall A Akutex FT 40 mm, 43 mm o.d.s.
  - Akusto Wall A Texona 40 mm, 43 mm o.d.s.
  - Akusto Wall A Super G 40 mm, 43 mm o.d.s.
- o.d.s = overall depth of system

	THK mm	o.d.s. mm	$\alpha_p$ , Practical sound absorption coefficient						$\alpha_w$	Sound absorption class
			125 Hz	250 Hz	500 Hz	1000 Hz	2000 Hz	4000 Hz		
Akutex FT	40	43	0.20	0.70	1.00	1.00	1.00	1.00	1.00	A
Texona	40	43	0.15	0.65	1.00	1.00	1.00	1.00	1.00	A
Super G	40	43	0.15	0.65	1.00	1.00	1.00	1.00	0.95	A

THK mm	AC(1.5) Articulation Class, ASTM E1111, ASTM E1110
40	230



## INDOOR AIR QUALITY

Certificate / Label	Akutex FT White Frost		Texona	Super G
Eurofins Indoor Air Comfort*	IAC Gold	IAC	IAC Gold	IAC Gold
French VOC	A+	A+	A+	A+



## CRADLE TO CRADLE CERTIFIED®

Akusto products with Akutex FT surface are Cradle to Cradle Certified® at Bronze level (version 4.0).



## MATERIAL HEALTH

Akusto products with Akutex FT surface have received a C2C Certified Material Health Certificate™ at the Silver level (standard version 4.0). The C2C Certified Material Health Certificate™ is a verification of the health and safety of a product's composition using the Material Health requirements of the Cradle-to-Cradle Certified Product Standard.



## CARBON FOOTPRINT

Life-cycle stages A1 to C4 from EPD, in conformity with ISO 14025 / EN 15804

	kg CO <sub>2</sub> equiv/m <sup>2</sup>
Akusto Wall A - Texona	4,74 (Akusto Wall A EPD in conformity with ISO 14025 / EN 15804)
Akusto Wall A - Akutex FT	3,96 (Akusto Wall A EPD in conformity with ISO 14025 / EN 15804)
Akusto Wall A - Super G	6,21 (Akusto Wall A EPD in conformity with ISO 14025 / EN 15804)



## CIRCULARITY

Minimum post-consumer recycled content	53%
Recyclability	Fully recyclable



## FIRE SAFETY

The glass wool core of the tiles is tested and classified as non-combustible according to EN ISO 1182.

Country	Fire standard	Class
Europe	EN 13501-1	A2-s1,d0



## HUMIDITY RESISTANCE

Class C, relative humidity 95% and 30°C, according to EN 13964:2014



## VISUAL APPEARANCE

Akusto Wall in white has high light reflectance. Light reflectance and nearest NCS colour sample for all the different colours: See Ecophon Colours and surfaces.



## CLEANABILITY

Daily dusting, vacuum cleaning and weekly wet wiping (Super G and Akutex FT surfaces). Weekly dusting and vacuum cleaning (Texona surface) as required.



## ACCESSIBILITY

The tiles are not demountable except in selected installation diagrams. See quantity specification for more information.



## INSTALLATION

Installed according to installation diagrams, installation guides and drawing aid. For information regarding minimum overall depth of system see quantity specification. The systems should not be placed behind goals or similar areas where they are likely to be hit regularly. In such cases a protective net in front of the system is recommended.



## PACKAGING INFORMATION

Information is indicative and subject to change.

	Edge	Panels / crt	m <sup>2</sup> / crt
2700x1200x40	A	4	12.96



## SYSTEM WEIGHT

Weight information is indicative and subject to variation.

	kg/m <sup>2</sup>
Akusto Wall A/Akutex FT	2,5
Akusto Wall A/Texona	2,5
Akusto Wall A/Super G	2,7



## MECHANICAL PROPERTIES

No additional live load is allowed.



## IMPACT RESISTANCE

Tested and classified to fulfil the requirements of DIN 18032-3, equivalent to 1A according to EN13964. Texona surface has moderate impact resistance. Please note: Where the panels are subjected to frequent blows and impacts e.g. behind goal mouths, protection in form of e.g restraining nets or wooden slats is required.

Surface	M-scratch	Classification
Super G	M353	Fulfills



## CE

Ecophon ceiling systems are CE marked according to the European harmonized standard EN13964:2014. CE marked construction products are covered by a Declaration of Performance (DOP) which enables customers and users to easily compare performance of products available on the European market.

## COLOURS AND DESIGN

### Super G



### Akutex™ FT

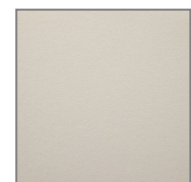
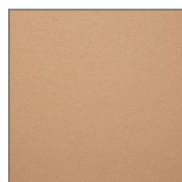
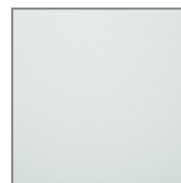



Silver Stone

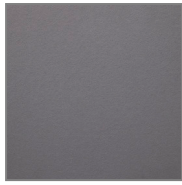

Silk Slate

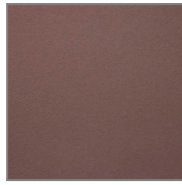

Dark Chestnut

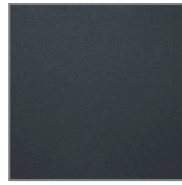

Basalt Rock

**Texona**



Winter White



Stone Grey



Silver Lining

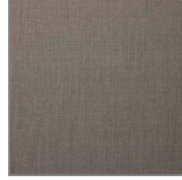

Thunder Grey

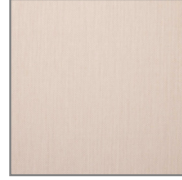

Oat Beige

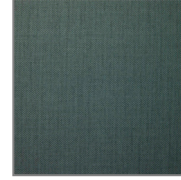

Deep Forest



Linden Green



Midnight Sky



Ice Blue



Autumn Berry



Heathland Rose



Cloudy Pink



Golden Sand

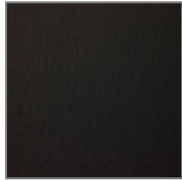

Shadow Black

Channel trim + Impact resistant

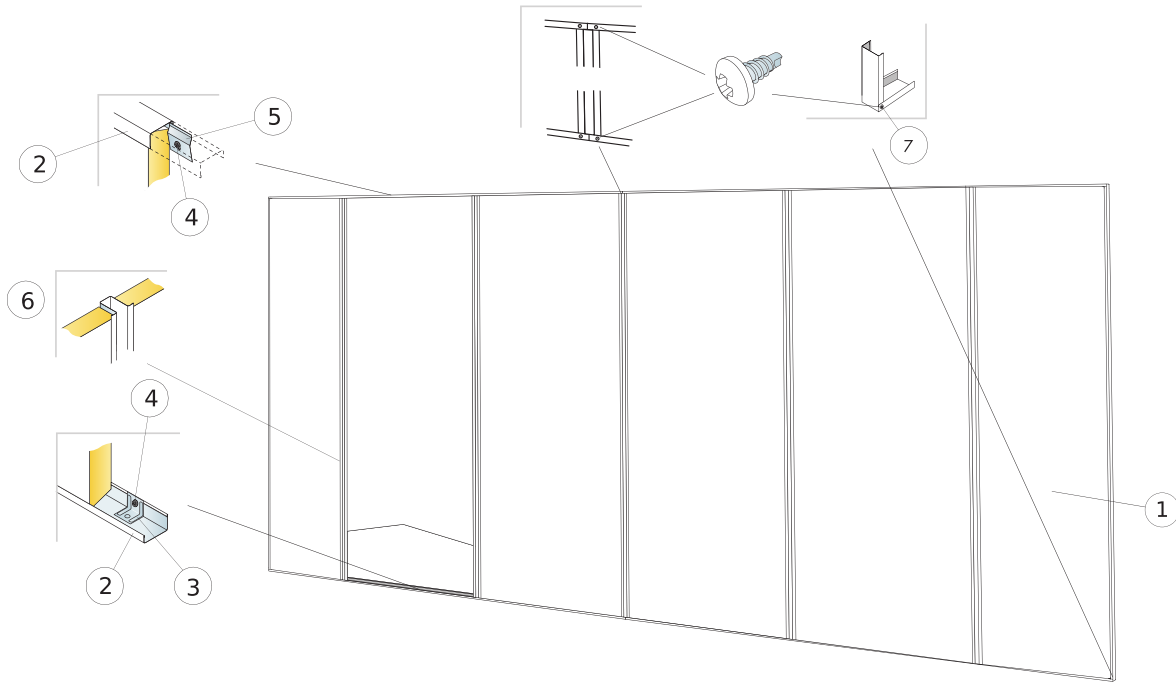

© Ecophon Group

Installation diagram (M353) for Ecophon Akusto Wall A

Quantity specification (excl. wastage)

	Size, mm
	<b>2700x1200</b>
1 Ecophon Akusto Wall A/Super G	0,31/m <sup>2</sup>
2 Connect Channel trim, fixed at 300 mm centres. Connect Direct fixing plate is placed inside at each fixing point if the panel is not supported by the floor.	as required
3 Connect Direct fixing plate	as required
4 Connect Installation screw MVL (for use in plasterboard or timber)	as required
5 Connect Fixing bracket, fixed at 400 mm centres.	as required
6 Connect Recessed profile plus	as required
7 Connect Installation screw BR (2000 pcs)	as required
Δ Min. overall depth of system: 44 mm	

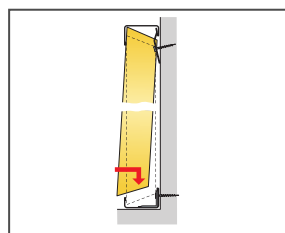
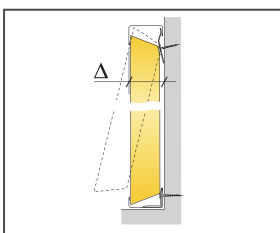

Detail of installation

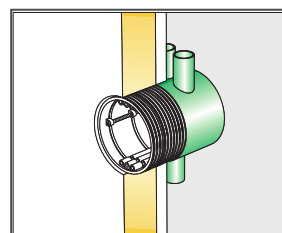

Accessories for adjusting electrical installations are available in electricity retail stores

Size, mm	Max live load (N)	Min load bearing capacity (N)
2700x1200x40	0	-

Live load/load bearing capacity

Channel trim

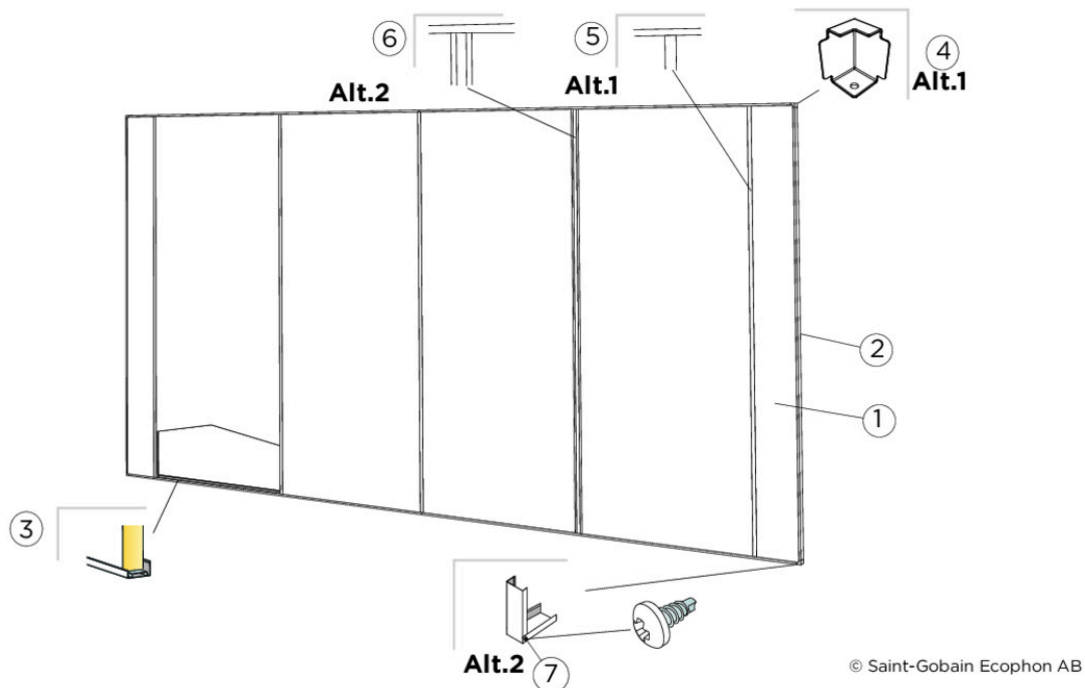

Installation diagram (M504) for Ecophon Akusto Wall A

Quantity specification (excl. wastage)

	Size, mm
	<b>2700x1200</b>
1 Ecophon Akusto Wall A	0,31/m <sup>2</sup>
2 Connect Channel trim, fixed at 300 mm centres. Connect Direct fixing plate is placed inside at each fixing point if the panel is not supported by the floor.	as required
3 Connect Thinline Space Bar, L=2550 mm	as required
<b>Mounting Option 1</b>	
4 Connect Channel trim corner	as required
5 Connect T24 Main runner, (Installation: kept in position with the Channel trims)	as required
<b>Mounting Option 2</b>	
6 Connect Recessed profile, (Installation: kept in position with the Channel trims)	as required
7 Connect Installation screw BR	as required
Δ Min. overall depth of system: 44 mm	
Connect Installation screw MVL (for use in plasterboard or timber)	as required

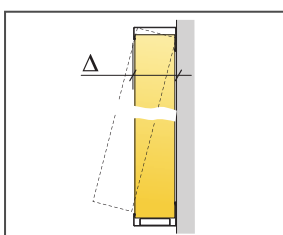

See Quantity specification

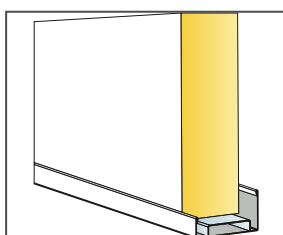

Installation with Channel trim and WP Space bar

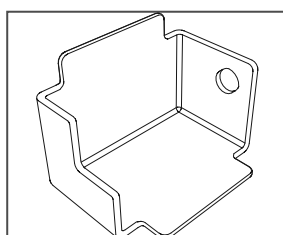

Connect Channel trim corner for 44mm profile

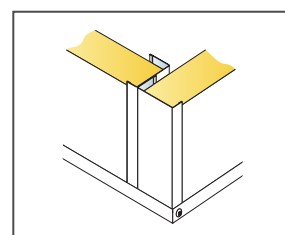

Corner installation with Channel trim and BR screw

Single panel + Connect Thinline + Vertical

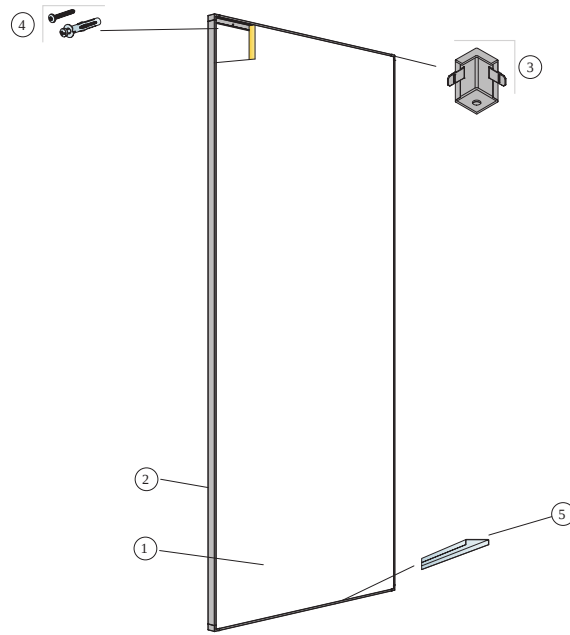

© Ecophon  
Installation diagram (M593) for Ecophon Akusto Wall A vertical installation with Connect Thinline profiles.

Quantity specification (excl. wastage)

		Size, mm
		<b>2700x1200</b>
1	Ecophon Akusto Wall A	0,31/m <sup>2</sup>
2	Connect Thinline Profile, L=2658 mm	as required
3	Connect Thinline Ext. Corner	as required
4	Installation screw, installed at 400 mm centres (select fastener according to wall material)	as required
5	Connect Thinline Space Bar, L=2550 mm	as required
Δ Overall depth of system: 45 mm		

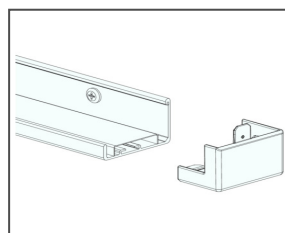
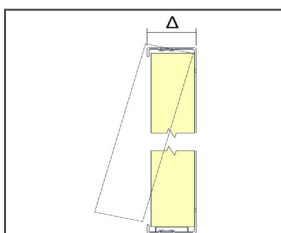

Thinline system detail

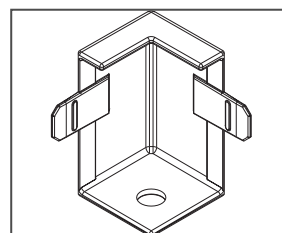

Detail of Thinline corner

Single panel + Connect Thinline + Horizontal

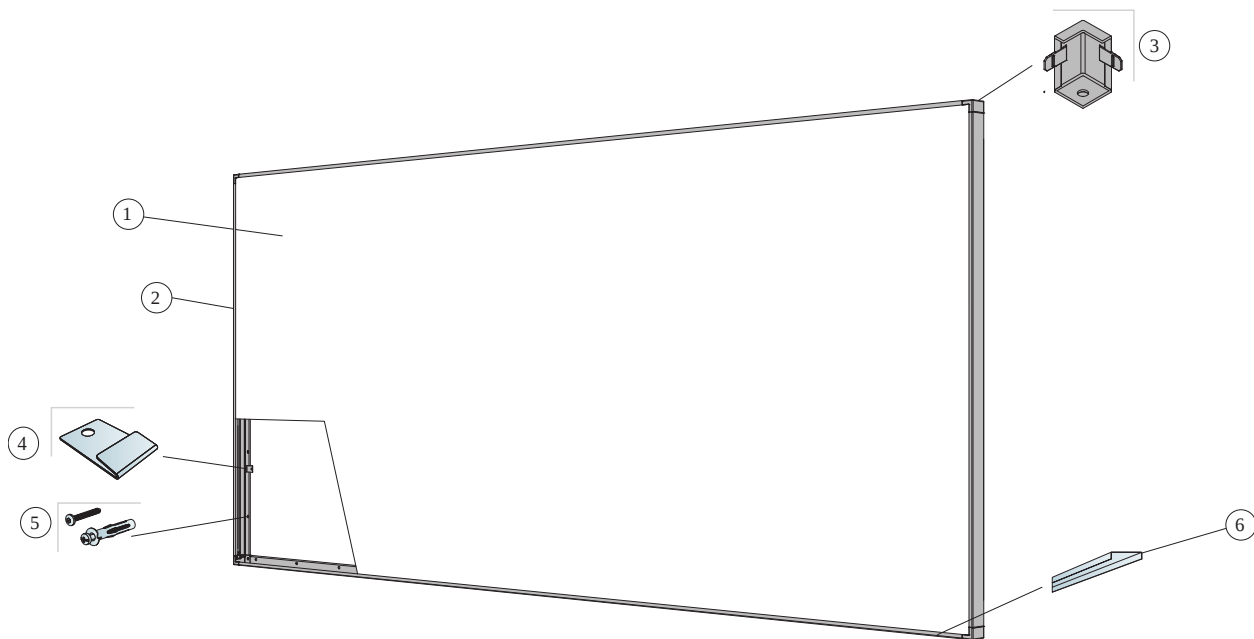

© Ecophon

Installation diagram (M595) for Ecophon Akusto Wall A horizontal installation with Connect Thinline profiles.

Quantity specification (excl. wastage)

	Size, mm
	<b>2700x1200</b>
1 Ecophon Akusto Wall A	0,31/m <sup>2</sup>
2 Connect Thinline Profile, L=2658 mm	as required
3 Connect Thinline Ext. Corner	as required
4 Connect Thinline Locking Clip	as required
5 Installation screw, installed at 400 mm centres (select fastener according to wall material)	as required
6 Connect Thinline Space Bar, L=2550 mm	as required
Δ Overall depth of system: 45 mm	

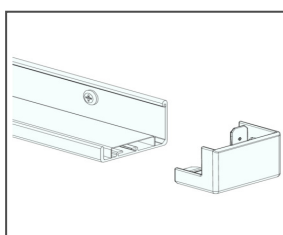
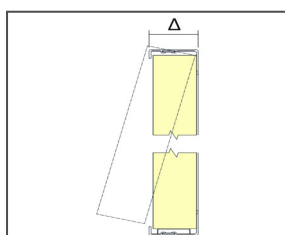

Thinline system detail

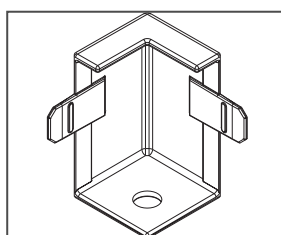

Detail of Thinline corner