



(47)	Ln2
------	-----

System 5000

FLAME-FREE, FELT SYSTEM, INSTALLED USING HOT AIR, TOTALLY ELIMINATING FIRE RISK AND PROVIDING A BITUMEN ALTERNATIVE TO SINGLE PLY



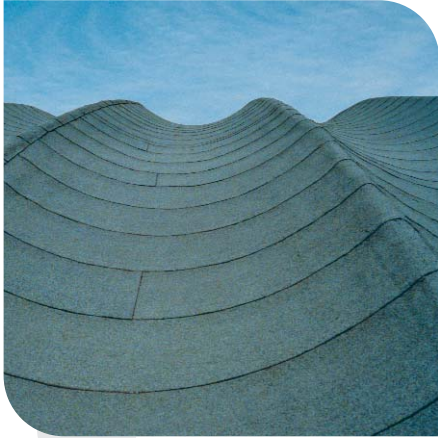

Bailey System 5000

Flame-free felt roofing

BAILEY SYSTEM 5000 IS A SINGLE LAYER, FLAME-FREE FELT ROOFING SYSTEM. INSTALLED USING HOT AIR, TOTALLY ELIMINATING FIRE RISK AND PROVIDING A COMPETITIVE, BITUMINOUS ALTERNATIVE TO SINGLE PLY SYSTEMS. SYSTEM 5000 IS MANUFACTURED WITH AN UNTEARABLE SPUNBOND POLYESTER CARRIER, COATED WITH AN SBS (STYRENE BUTYL STYRENE) MODIFIED BITUMEN AND AN OVERALL THICKNESS OF APPROXIMATELY 5MM.



BAILEY ROOFING SYSTEMS HAS BEEN INVOLVED WITH FLAT ROOFING FOR OVER 30 YEARS. FROM THE BEGINNING THEIR COMMITMENT HAS BEEN TO SUPPLY ONLY THE BEST QUALITY MATERIALS, OFFERING THE LONGEST LIFE EXPECTANCY AND PERFORMANCE AVAILABLE FOR BOTH NEW BUILD AND REFURBISHMENT, BAILEY'S RANGE OF PRODUCTS AND DEPTH OF KNOWLEDGE IN THE INDUSTRY ALLOW THE SPECIFIER TO SELECT THE SYSTEM BEST SUITED TO THE FLAT ROOF PROJECT.

THE BAILEY 5000 ROOFING SYSTEM OFFERS THE FOLLOWING BENEFITS:

- Safe and secure – flame-free felt roofing system, applied with hot air
- Manufactured with superior quality modified bitumen
- Competitively priced single-layer roofing system

System



System 5000 – Safe and Secure

Bailey recognised the need in the market place for a bituminous system that was safe to install. System 5000 with its traditional mineral felt finish and specially modified bitumen, which can be activated using hot air, is the perfect solution. System 5000 being single layer, provides a suitable alternative for projects where the budget does not allow for the use of a single ply membrane, or where a bitumen system is preferred. Traditional flat roofing installation involves two methods:

- 'Roll and Pour' using bitumen boilers, which have been in use for at least the last one hundred years.
- 'Torch-on' methods where the bitumen on the back of the felt is activated by a naked flame, this method has been in use for the last 30 years.

Both methods produce good results but they have a high fire risk and in recent years many costly fires have been started by flat roofers using naked flames or boilers. One of the worst was the disastrous fire that destroyed 'The Centre-Parcs' establishment in Suffolk, resulting in an insurance claim in excess of £120 million. As a result the insurance industry penalised roofing contractors using traditional methods. In addition, 'roll and pour' methods can be messy causing contamination of clothing, burns and skin diseases.



Bailey System 5000 overcomes these problems and offers significant benefits to both the client and the installer. Installation is rapid and efficient without the use of naked flames or boilers, greatly reducing the risk of fire and injuries caused by hot bitumen. System 5000 gives the client peace of mind due to the cleaner and safer site conditions, and the reduction of disturbance to occupants of the building. As a result, System 5000 has been used on many school projects as it is safe to use during term time. The added benefits for installers include lower insurance premiums, improved health and safety conditions and less equipment and tools are required.

System 5000 has been proven to be successful on many notable installations. System 5000 is a flexible membrane, enabling absorption of substrate movement, thus resulting in a cost effective flat roof with a life expectancy in excess of 30 years.

Quality Manufacture

Since the 1950s and 60s when flat roofing had a poor reputation there have been great advances in roofing. Bailey has been at the forefront of these advances and have supplied only high performance products that are simple to install and offer a long lasting flat roof. The time has now come to move on and use materials and methods which are inherently safe as well as effective.

Bailey System 5000 is a high performance product with a spunbond polyester carrier and a special elastomeric SBS modified bitumen. The secret of an excellent product is the blending of the right proportions of bitumen, plasticisers and fillers. System 5000 is manufactured using the latest technology and is continually monitored, the manufacturing process is subject to stringent quality control in accordance with ISO 9001. A sample from every batch is tested and retained in the laboratory for 9 months and on each roll there is a label with the batch number, giving full traceability.

The manufacturing plant has been extensively upgraded and modernised over the years and is now fully automated.



5000



Experienced Installation

Bailey System 5000 is installed only by recommended contractors who are experienced and trained in installation of bituminous products. To ensure workmanship is up to Bailey's required standard of excellence in flat roofing, a series of site inspections are carried out during the course of the installation. Bailey's technical personnel assist and advise with detailing and laying of the system resulting in a successful installation. On completion of the project prior to issue of the guarantee, a final inspection is carried out usually accompanied by the client or his representative surveyor to ensure a satisfactory result.

Water-tight Guarantee

System 5000 is available with a 15 year manufacturer's guarantee. On some projects, it is possible to have a 15 year insurance backed guarantee.

The guarantee is one of the best available, as it covers not only replacement of faulty materials, but correction of faulty installation and consequential damage to contents of buildings.

The guarantee is provided by an internationally recognised insurance company, with UK offices and is not subject to payment of an annual fee by either the client or the manufacturer to ensure its validity. It is purchased by the manufacturer in the year of inception and is therefore independent of either the continuance of the contractor, the importer or the manufacturer. To qualify for an insurance backed guarantee it is essential that Bailey are given details of the project at the onset and either approve or provide the specification. Details of recommended installers will be provided and it will be necessary for interim and final inspection reports to be issued by Bailey technical personnel.

Technical Information

Characteristics	Test method UEAtc	Unit of Measure	Typical values
Thickness: on selvedge	A	mm	4
Roll length	-	m	8
Roll width	-	cm	100
Mass	B	Kg/m ²	5,1
Tensile strength (1)	C	N/5cm	L=900
Tensile strength (1)	C	N/5cm	T=700
Elongation (1)	C	%	L=50
Elongation (1)	C	%	T=50
Resistance to tear (1)	5.4.1	N	L=>150
Resistance to tear (1)	5.4.1	N	T=>150
Static puncture on hard support: Class	5.1.9	L*	L4
Static puncture on insulation board: Class	5.1.9	L*	L4
Cold flexibility	D	°C	-25
Dimensional stability	5.1.6.1	%	L=0,3
Heat resistance	E	°C	100
Water tightness	5.1.4	KPa (2)	60 KPa
Water vapour permeability	5.1.11	g/m ² /day	0,1

(1) Above tolerances are according to UEAtc norms (Jan 1984)

(2) 1Kpa = 0,1 water column

4 = No loss of impermeability under load of 25kg

System

Standard details

DRIP EDGE

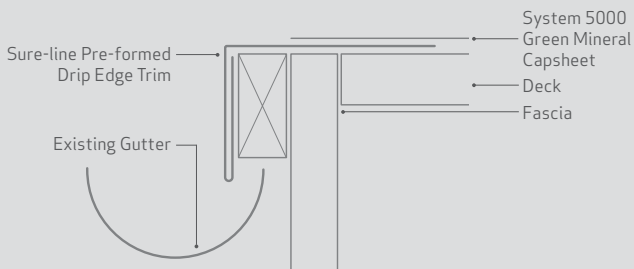

WATERCHECK

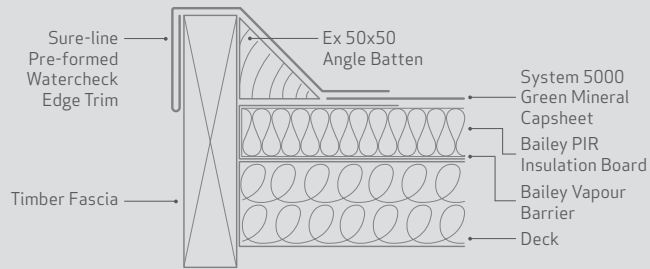

COLD PIPE

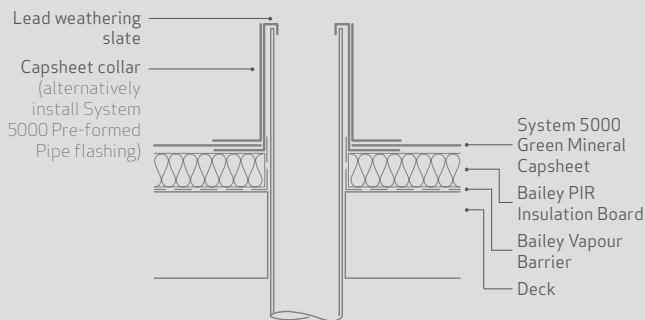

UPSTAND FLASHING

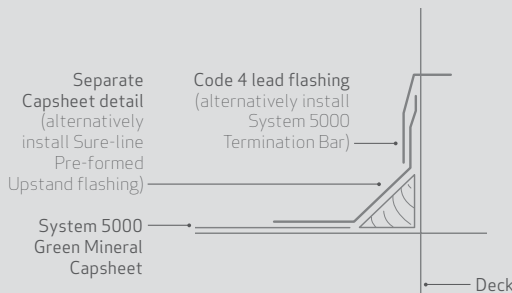

Flexible Specifying

Bailey System 5000 is suitable for most types of roof, including those of unique design and shape.

As every flat roof project is different, it is essential that the right system is selected. At Bailey, as well as having a solution to every flat roof situation, their experience of over 30 years in the industry is made available at every stage. Bailey advises involvement at the very earliest design stage of a project to ensure the best results. Bailey technical personnel are able to receive architect's plans of new build projects or carry out a detailed survey (including a core sample) with a comprehensive report for repair or refurbishment.

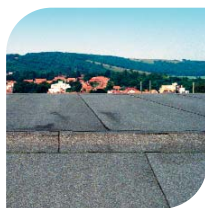

Following this a specification can be provided, recommending the most suitable system. Bailey's recommendation will offer the best solution within the budget without cutting corners or compromising on quality.

Once this system has been specified, Bailey will provide names of recommended contractors who will be willing to tender for the works. Projects are policed by Bailey and reports of inspections produced. On completion of the works a final inspection is carried out, the job signed off and the guarantee issued.

To draw on Bailey's expertise and for further assistance and advice, call the Technical Sales Department on:

01444 244330



5000

The Complete System

Whatever the specification, Bailey can supply 'the complete system' together with expert advice, assistance and recommendations. Bailey System 5000 comes complete with a whole range of fixings and preformed components allowing an entirely flame-free installation, with neat and effective detailing.



Bailey Laminar Vapour Barrier

An aluminium cored bituminous membrane providing an effective vapour barrier as opposed to a vapour check. In addition, the top surface has a sanded finish allowing insulation board to be bonded using adhesive. Bailey Laminar can be mechanically fixed and the laps sealed using a hot air gun.

Bailey Self Adhesive Vapour Barrier

An alternative SBS bitumen based vapour barrier, with an untearable reinforcement. Self adhesive both sides with easily removable film, ensuring a rapid and safe installation.

Bailey PIR Insulation Board

Environmentally friendly highly efficient polyurethane board, containing no CFCs or HCFCs. Tapered insulation schemes are available to help reduce ponding, which is common on many older flat roofs.

Bailey System 5000 Mineral Capsheet (Mech fix)

A 5.2kg/m² capsheet, manufactured using a special SBS modified bitumen and spunbond polyester carrier, with added glass fibre for stability. The top surface is finished with a green mineral and the membrane backed with sacrificial polythene film.

Bailey System 5000 Mineral Capsheet (Adhered)

Again, a 5.2kg/m² capsheet manufactured using a special SBS modified bitumen and spunbond polyester carrier. The membrane is backed with a fleece material, enabling adhesion using Bailey Sure-bond cold applied PU adhesive.

Bailey Sure-bond PU Adhesive

A versatile one pack adhesive, bonds a number of different materials to a variety of substrates, including brickwork, metal, timber and concrete.

Bailey Sure-line

A preformed roof edging system used in conjunction with System 5000 to aid a rapid and efficient installation. Sure-line comes in four different profiles – drip edge, water check, upstand flashing and wall cover flashing.

PLEASE ENQUIRE ABOUT OUR COMPREHENSIVE RANGE OF BAILEY ROOFING SYSTEMS:

- Bailey Atlantic Sustainable Single Ply
- Bailey System 17000 High performance, torch-on roofing system
- Bailey Classic (SBS) Commodity Range
- Bailey System 12000 (APP) Commodity Range
- Bailey Sure-Line Preformed Roof Edging System

System

Bailey System 5000 Specifications

Plywood deck (cold roof)

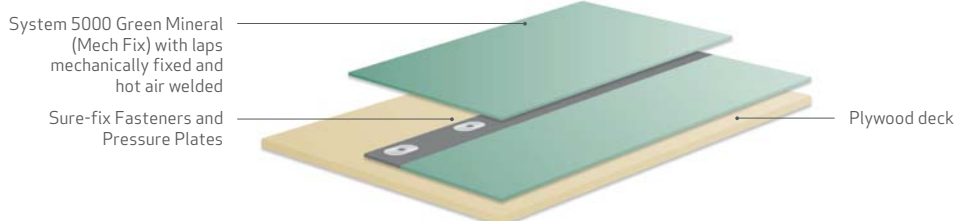

Concrete deck / Asphalt overlay (warm roof)

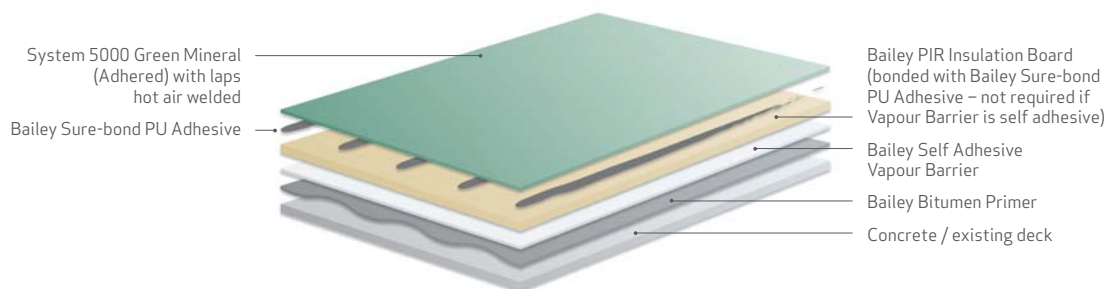

Profile metal deck (warm roof)

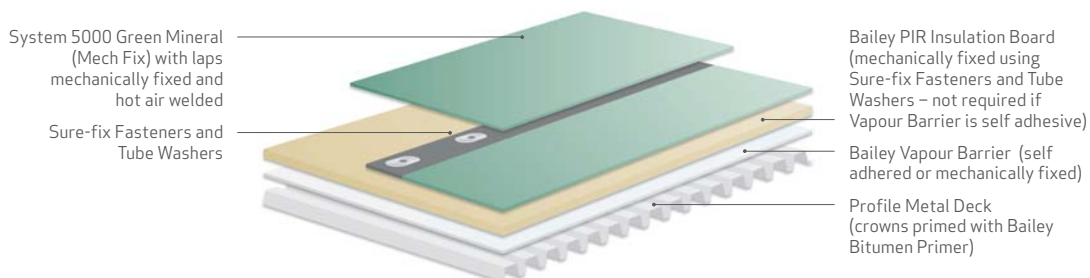

5000



Bailey Roofing Systems
Victoria Gardens
Victoria Industrial Estate
Burgess Hill
West Sussex
RH15 9NB

Tel: **+44(0)1444 244330**

Fax: +44(0)1444 244342