



Revolving Doors
Comfortline

DORMA KTC-2



A high-quality entrance system offering elegance plus versatility

The entrance is the showcase of a building. No other component makes such a lasting first impression on visitors or complements the façade so effectively. High requirements therefore have to be placed on the visual quality of a door system, on its design and functionality. The DORMA KTC-2 2-wing

revolving door offers plenty of scope for architectural creativity. Thanks to the variability of its design and a broad selection of surface finishes, it will enhance the entrance of any building, giving it both uniqueness and style. Easy to operate and ideally suited to the requirements of wheelchair

users, the DORMA KTC-2 also raises accessibility and convenience to a new level. The wide range of functions ensures a high throughput capacity even during peak traffic periods, plus unbeatable safety. And there are major additional benefits to be had from the suitability of these doors as display and advertising vehicles. It is important for the economic operation of a building to guarantee effective protection of its interior against the cold, heat, draughts, noise, dust

and dirt. The two-wing DORMA KTC-2 revolving door comprehensively meets all these requirements. Available in three standard sizes, with two breakout door wings equipped with catch and pivot fittings as standard – either as a full-width arrangement or with outlying showcases – DORMA KTC-2 revolving doors are suitable for a variety of applications. System options include an integrated night shield and the choice of either glazed or metal panelled drum walls.

Data and features **DORMA KTC-2**

Inside diameter in mm (D)	3600, 4200, 4800
Outside diameter in mm (B)	3828, 4428, 5028
Clear passage width in mm (LW)	1645, 1945, 2245
Clear emergency escape width in mm	= LW
Clear passage height in mm (LH)	up to 2200
Canopy height in mm	410-710
Total height in mm (H)	up to 2910
Side walls glazed	○
Side walls with metal panelling	○
Suitable for emergency exits and escape routes	○
Floor ring	●
Floor covering	○
Downlights (4)	●
Prepared for rainproof roof	○
German type approval	●

● Yes ○ Option

Plus points

... for the installer

- Tailored to suit widely differing structural conditions
- Trouble-free installation and commissioning
- Most up-to-date technology conforming to all relevant national and international standards

... for the architect/specifier

- High degree of design flexibility thanks to a wide range of modular components
- Problem-free adaptability to individual requirements

- Visually, technically and economically convincing solution

... for the user

- Integrated system manufactured with industrial precision and assured quality
- Optimisation of the building energy balance and workplace environment
- Exceptional user convenience
- Outstanding safety features

Traffic capacities

	Theoretical capacity ¹⁾	Practical capacity ²⁾		Maximum capacity ³⁾
Inside diameter (D) in mm	Persons/hour →	→	Persons/hour ↔	Persons/min. →
3600	2160	720	1440	36
4200	2880	960	1920	48
4800	3600	1200	2400	60

¹⁾ The theoretical capacity value indicates how many people can pass through the revolving door in one (→) direction per hour, assuming that the traffic flow is uniform and the internal segments are fully occupied.

²⁾ The practical capacity values indicate how many people can actually pass through the revolving door in one (→) and in both (↔) directions.

³⁾ The maximum capacity value indicates how many people can pass through the revolving door in one direction (→) per minute when there is a constant stream of traffic, e.g. in the morning and evening.













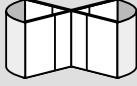
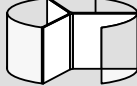
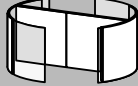
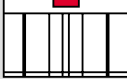

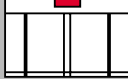
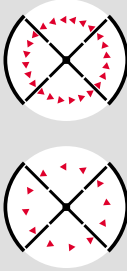
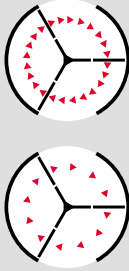
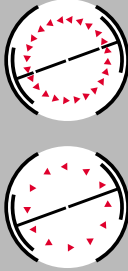





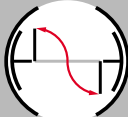

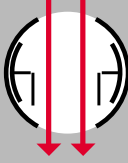

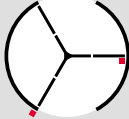
German type approval



Quality assured manufacture to DIN ISO 9001, EN 29001, BS 5750. Certified and verified by BSI Quality Assurance Reg. No. Q 6423, FM 10756



Designs, functions, standard equipment, optional extras

Models	KTC-4/0	KTC-3/0	KTC-2/0
			
Operator types			
Canopy-integral drive unit			
Automatic			
<p>I: Door starts and stops automatically</p> <p>II: Door rotates continuously at low speed which is increased as soon as a user approaches the door</p>			
<p>Speed reduction feature</p> <p>decreases the speed to approx. 2 rpm (see page 11), e.g. for senior citizens, disabled persons</p>			
Configurations			
<p>Summer configuration</p> <p>Also ideal for the passage of bulky items or luggage, and for consignment deliveries</p>			
<p>Emergency escape configuration</p>			
Options			
<p>Manually or electrically locked wings</p>			
<p>Sliding night shields, internal</p>			
<p>Sliding night shields, external</p>			
<p>For 3 and 4-wing revolving doors, see the DORMA KTC-3/KTC-4 brochure</p>			

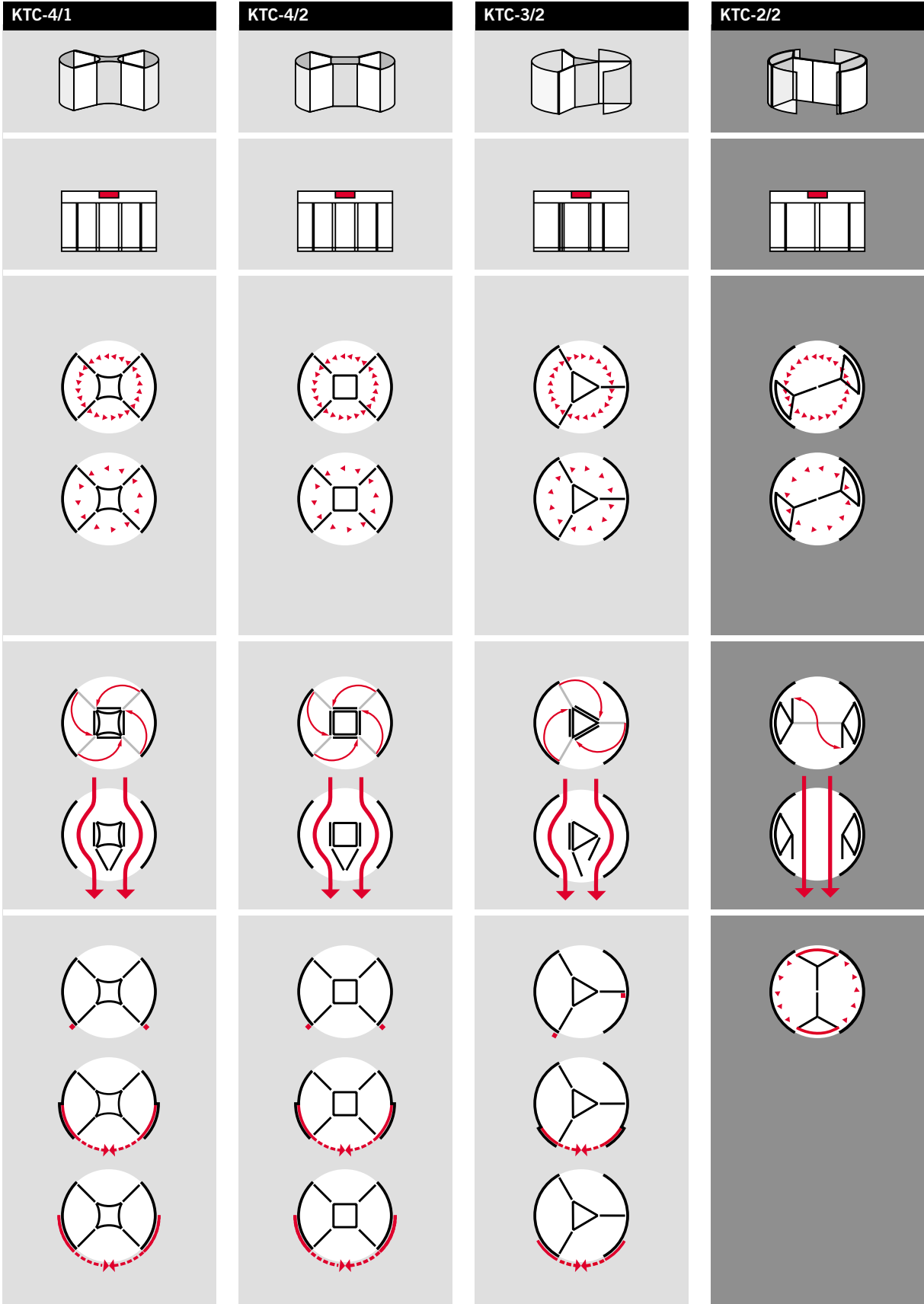

KTC-2/0 without showcases

- The 2-wing revolving door KTC-2/0 is available in three standard sizes
- With two breakout wings and horsehair brushes
- The integrated night shield is fitted with safety glass
- The drum walls can either be glazed or provided with metal panelling

Dimensions

Inside diameter (D)	3600	4200	4800
Outside diameter (B1)	3692	4292	4892
Outside diameter (B2)	3828	4428	5028
Clear passage width (LW)	1645	1945	2245
Clear passage height (LH)	up to 2200		
Canopy height (SH)	410-700		
Total height (H)	up to 2900		

All dimensions in mm.

KTC-2/0 without showcases

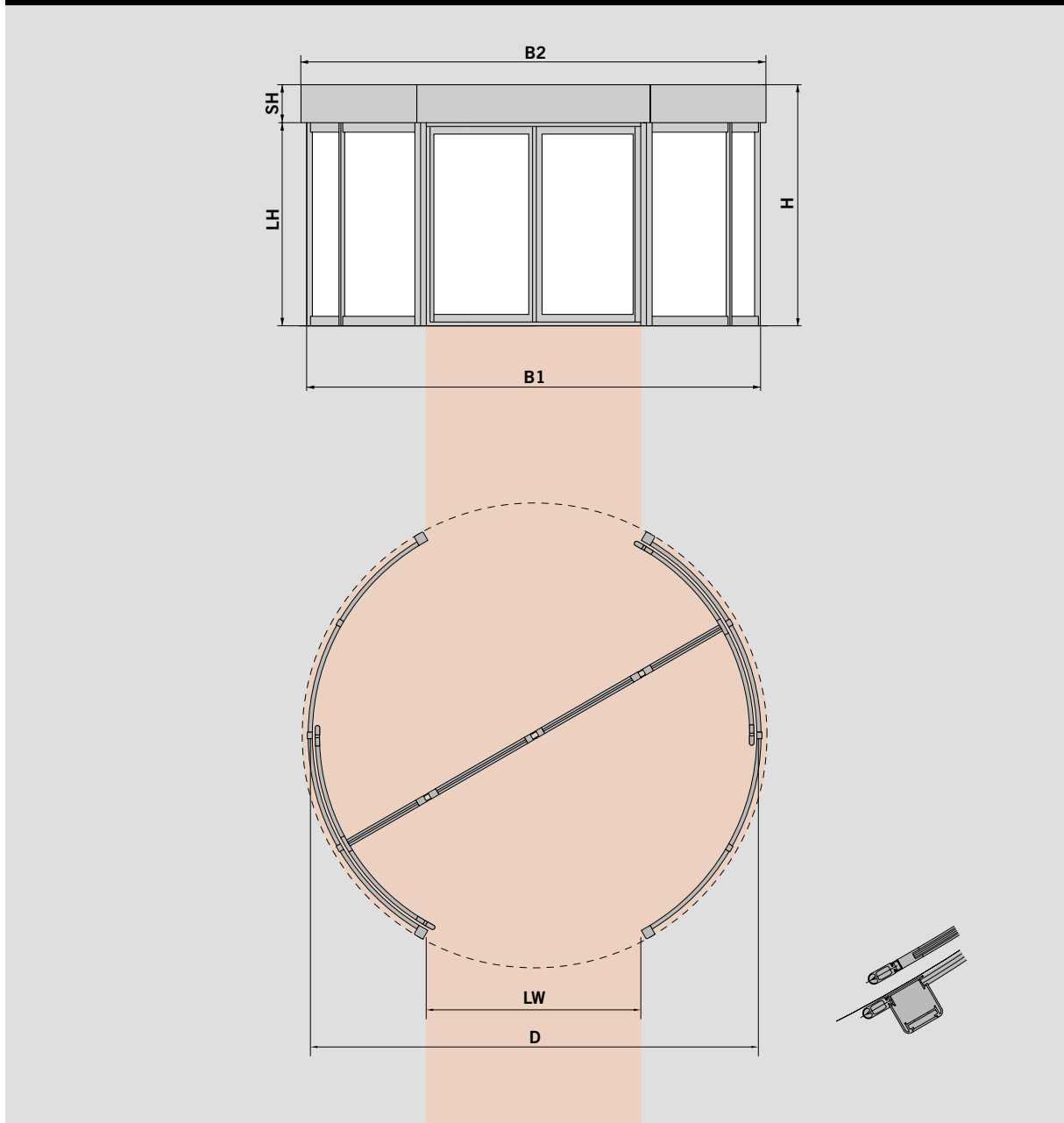

KTC-2/2 with showcases

- The 2-wing revolving door KTC-2/2 is available in three standard sizes
- With two breakout wings and horsehair brushes
- The integrated night shield is fitted with safety glass
- The drum walls can either be glazed or provided with metal panelling
- The KTC-2/2 model is additionally provided with two outlying triangular showcases

Dimensions

Inside diameter (D)	3600	4200	4800
Outside diameter (B1)	3692	4292	4892
Outside diameter (B2)	3828	4428	5028
Clear passage width (LW)	1645	1945	2245
Clear passage height (LH)	up to 2200		
Canopy height (SH)	410 - 700		
Total height (H)	up to 2900		

All dimensions in mm.

KTC-2/2 with showcases

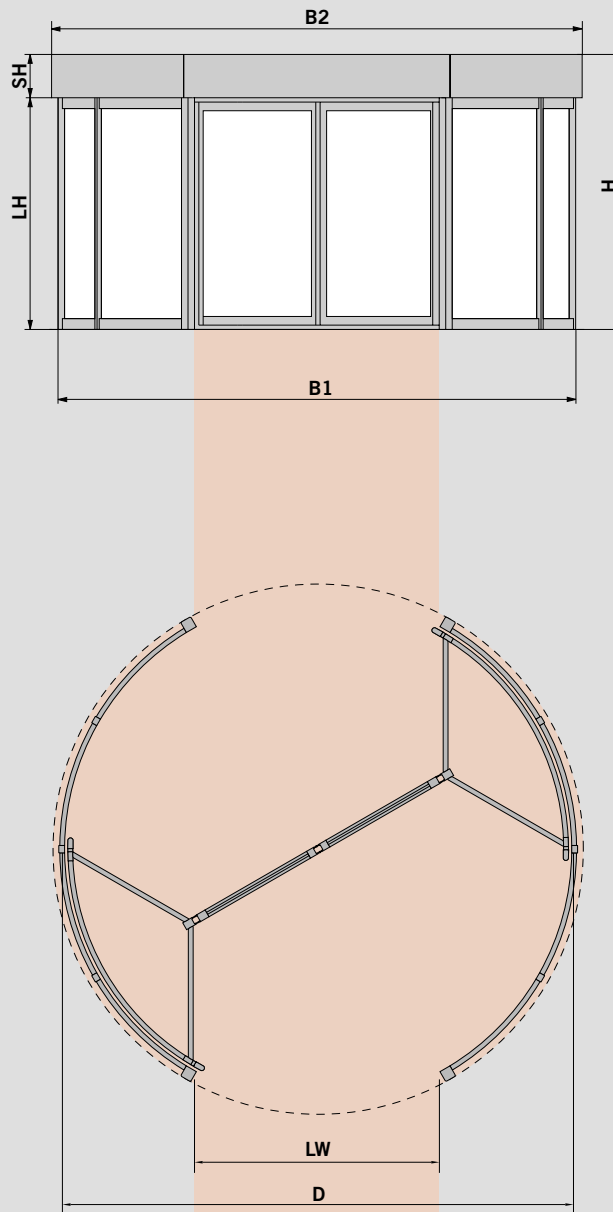

The ultimate in efficiency and convenience

Aside from different dimensions, the KTC range also offers numerous configurations to suit individual application requirements.

- KTC-2/0: 2-wing design without showcase
- KTC-2/2: 2-wing design with two outlying triangular showcases

- Fixed drum walls of special curved aluminium profiles with 10 mm laminated safety glazing
- Fixed drum walls of special curved aluminium profiles with metal panelling

Vertical section, basic model

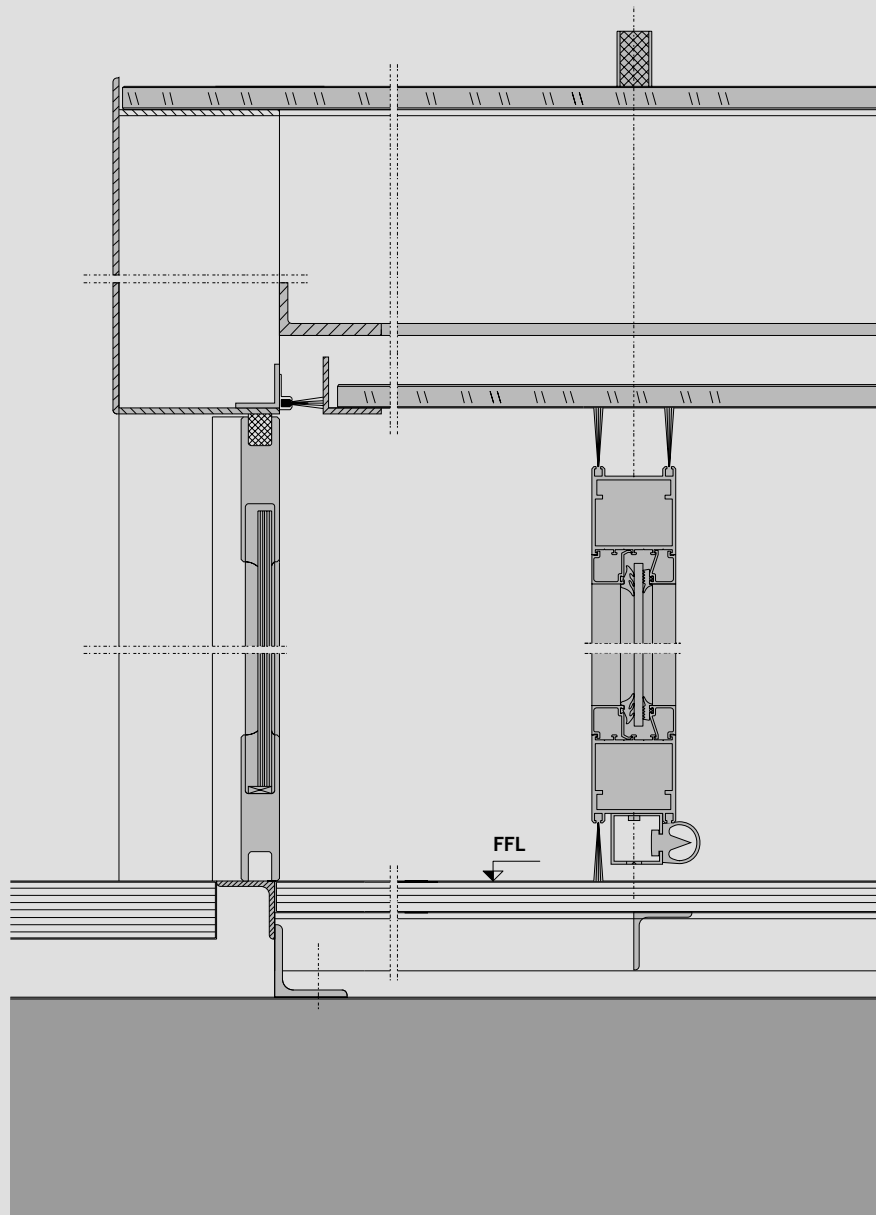

Vertical sections

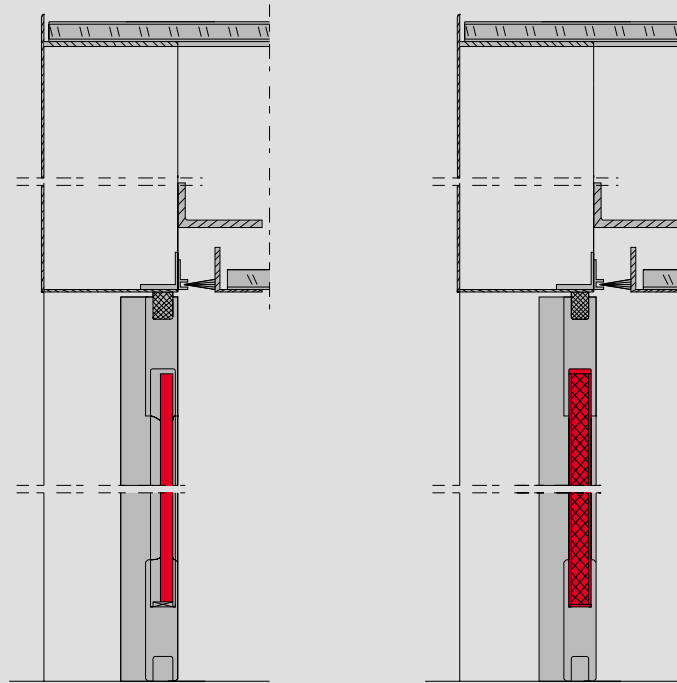

Glazed drum wall

Drum wall with metal panelling

Cable diagram

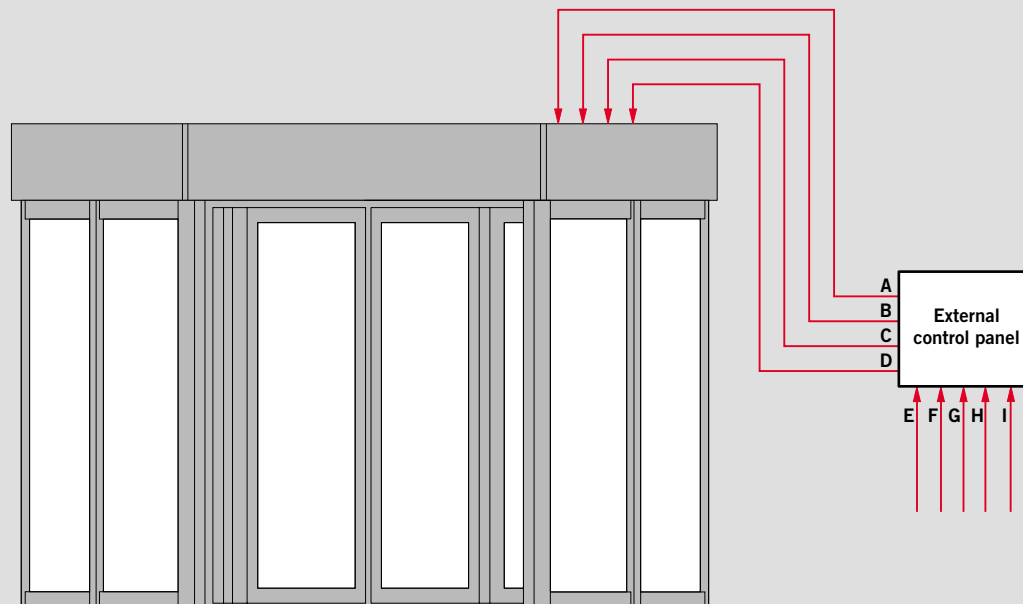

- A** Control system, 25 x 0.75 mm²
- B** Control system, 25 x 0.75 mm²
- C** Emergency power supply module, 4 x 1.5 mm²

- D** Motor, 3 x 1.5 mm², screened
- E** Lighting control, 2 x 0.5 mm²
- F** Group alarm, 2 x 0.5 mm²

- G** Fire detector contact, 2 x 0.5 mm²
- H** Remote control for locks, 3 x 0.5 mm²
- I** Power supply 230 V / 50 Hz / 10 A, 3 x 1.5 mm²

Control panel, external
 Height 800 mm
 Width 600 mm
 Depth 260 mm

Floor ring

Diameter (D)	3600	4200	4800
Subfloor to FFL (A)		70-250	
Nominal radius (R)	1800	2100	2400
Floor covering thickness (C)		up to 30	

All dimensions in mm.

Floor ring, KTC-2

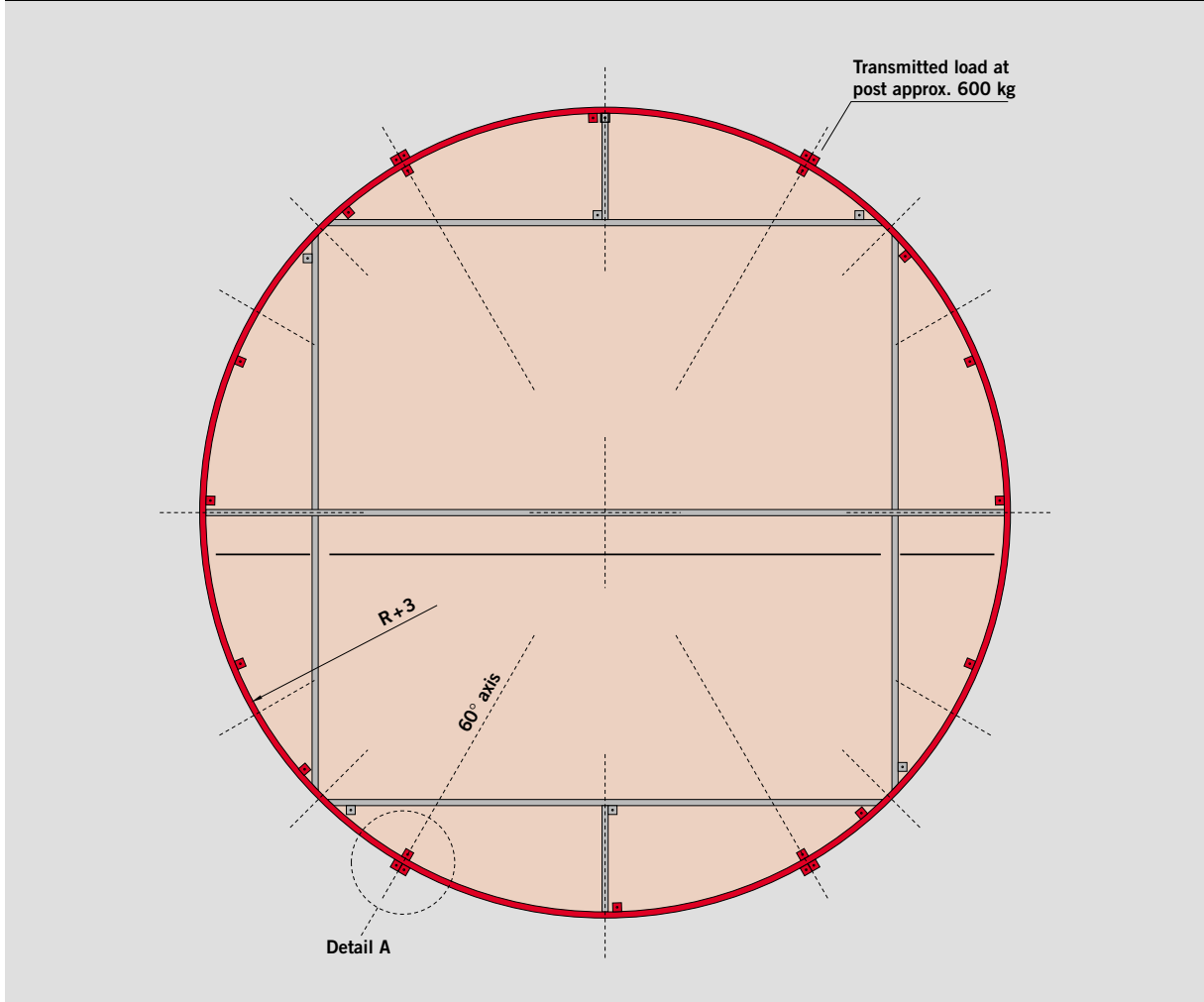

Detail A

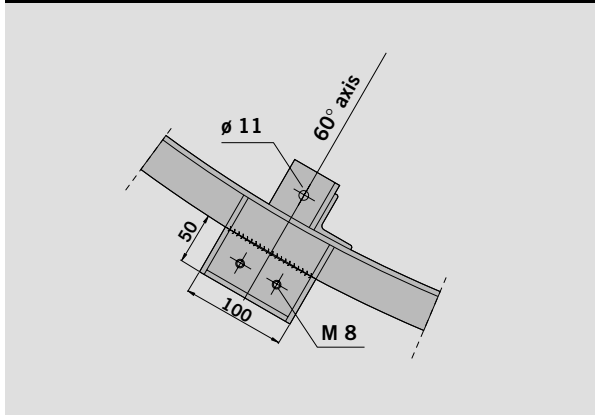

Cross section

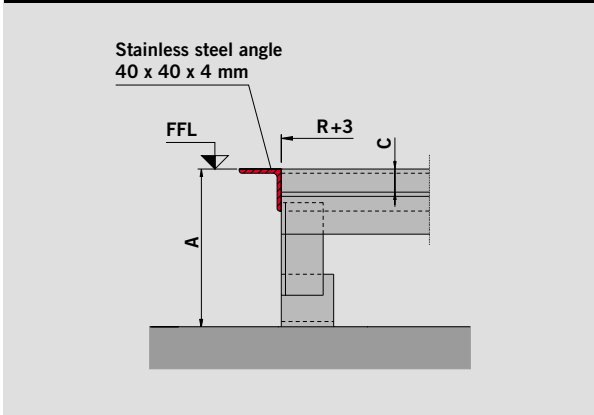

Safety equipment

DORMA KTC-2 revolving doors offer a comprehensive range of safety equipment to ensure optimum protection of people and objects as they pass through the entrance/exit system.

The main closing/shear edges are each equipped with two infra-red detectors and a safety contact strip. As the curved segment/showcase section arrives at a point 500 mm from the upright post at the end of the drum wall, the infra-red light detectors and the contact strip are activated. The outer edges of the night shield are likewise protected by safety contact strips.

The internal area is monitored with the aid of an infra-red light curtain. This detects the presence of any persons or objects that are moving too slowly for the revolving assembly, and will reduce the operating speed accordingly. If a door wing meets an obstruction, the door is stopped until the path is clear again. All the safety functions of the control system are of redundant design.

- ① Canopy sensors, 2 pairs, 2 infra-red detectors integrated in the canopy
- ② Contact strips on post, 2 units
- ③ Disabled access push-buttons, 2 units
- ④ Emergency stop push-button, 1 unit
- ⑤ Top sensors, 4 units (D ≥ 4800 mm: 6 units)
- ⑥ Wing limit switches, 2 units
- ⑦ Showcase door limit switches, 2 units (showcase wing systems only)
- ⑧ Wing safety contact strips, 2 units, bottom and showcase
- ⑨ Showcase safety contact strips, 2 units, bottom horizontal (showcase systems only)
- ⑩ Night shield outer edge contact safety strips, 2 units, vertical

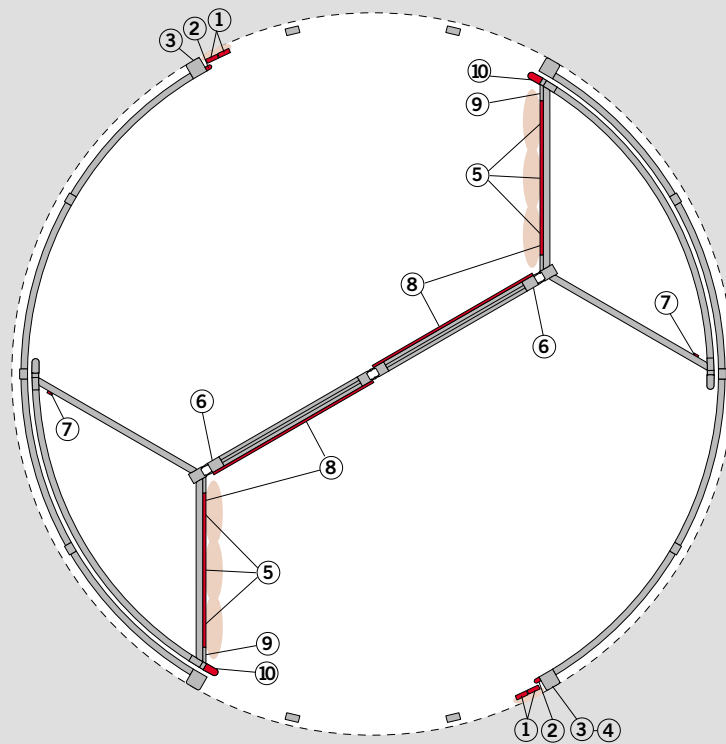
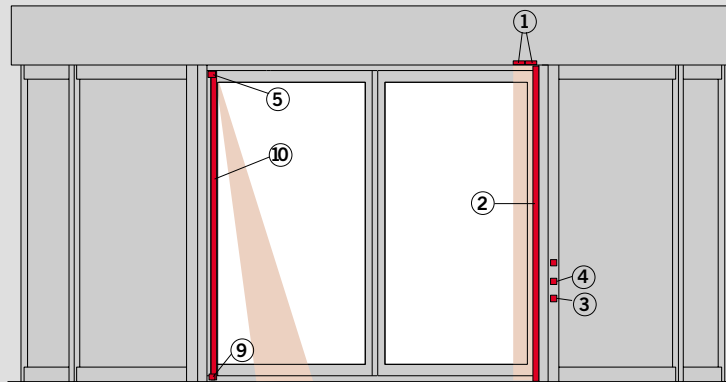

Automatic modes / Speed reduction feature

- The automatic control system offers two operating modes:

“Automatic I”:
The stationary door is activated as soon as a user approaches. Following an adjustable time, it stops again at its starting position.

“Automatic II”:
The door rotates continuously at approx. 1 rpm. As a user enters the detection range, the speed is increased to approx. 3 rpm. Once the user has left the detection range, the speed of the door is reduced again.

- The speed reduction feature is activated by means of a special push-button to reduce the speed of the door during passage to approx. 2 rpm.

Specification text

DORMA KTC-2 automatic revolving door suitable for installation in emergency exit and escape routes.

Type approval and certificates

TÜV approval to VDE 0700, Part 238, Code of Practice for Power-Operated Doors and Gates, ZH 1/494, latest edition, and also other DIN, UVV [Accident Prevention] and VDE specifications.

Outside diameter (B)mm Inside diameter (D)mm
Clear passage height (LH)...mm Overall height (H)mm

Rotary assembly

- with integrated night shield of transparent, 10 mm laminated safety glass, type GH, and 2 door wings of transparent safety glass, 6 mm toughened, aluminium-framed construction with horsehair brushes.
- with integrated night shield (outlying showcases) of transparent, 10 mm laminated safety glass, type GH, and 2 door wings of transparent safety glass, 6 mm toughened, aluminium-framed, horsehair brushes. The wings can be folded open, at which position they are automatically locked, to allow increased ventilation or the transfer of goods.

Ceiling: Revolving, with aluminium support structure, lower ceiling section of white melamine-laminated chipboard, with 4 integral downlights; aluminium panel upper ceiling.

Drive unit: 2 gear motors integrated in the ceiling assembly. Speed adjustable.

Drum walls

- stationary, of special aluminium profiles, curved, glazed with 10 mm type GH laminated safety glass, base section/glazing rail 100 mm high.
- stationary, of special aluminium profiles, curved, with metal panelling.

Support posts at the end of the fixed side sections with safety contact strips and activator mountings.

Canopy: Curved, of aluminium.

Movement detectors: 2 detectors inside and out, either integrated PIR or surface mounted radar units.

Locking

- electro-mechanical brake locking the rotary assembly (24 V), failsafe type (standard)
- mechanical with mortice deadlock (option)
- electro-mechanical bolts (option)

Control panel, external

with lockable cover, containing all the control elements.

Program switch

Installed in the support post; for selecting the modes "Automatic I", "Automatic II", "Summer Position", "Locked". In the "Automatic I" mode, the stationary door is activated as soon as a user enters the range of the movement detectors. Following an adjustable time, it stops again at its starting position. In the "Automatic II" mode, the door rotates continuously at approx. 1 rpm. As a user enters the detection range, the speed is increased to approx. 3 rpm. Once the user has left the detection range, the speed of the door is reduced again. In the "Summer Position" mode, the central assembly rotates to the mid-position and the door wings can be manually opened as required. In the "Locked" mode, the integrated night shield automatically closes the entrance.

Emergency escape position (option)

In the event of a power failure, operation of the emergency stop pushbutton or a fire alarm signal, the central assembly is rotated by a safety control module to a point where the wings can be manually broken out in the direction of escape for unhindered passage to safety.

Control system

Programmable logic control, with status display and diagnostics support, plus safety module for monitoring functions: all the safety commands and switching paths are of two-channel (redundant) design.

Safety system

Horizontally mounted sensor strips control the speed of rotation in accordance with the speed of passage of the people using the door. Thus the speed is also automatically adjusted to the speed of passage of disabled persons and senior citizens. The two main closing (shear) edges are protected by compressible safety contact strips. In addition, further sensors are activated as the wings pass a point 500 mm from the main closing edges. If these detect the presence of an obstruction (danger of crushing), they immediately trip the drive system. The drive system is designed so that the revolving door is stopped and prevented from any further rotation as soon as a wing makes contact with an obstacle.

Floor ring

Stainless steel angle 40 x 40 x 40 mm, for reliable anchorage of the door assembly and defined load transmission to the foundations.

Surface finishes

- RAL ...
- Anodised ...
- Stainless steel ...

Optional extras

- Floor mat
- Emergency escape expansion module

Subject to change without notice.

DORMA GmbH + Co. KG
P.O. Box 40 09
58247 Ennepetal
Germany
Tel. +49(0)23 33/7 93-0
Fax +49(0)23 33/7 93-4 95
www.dorma.com