



Revolving Doors  
Comfortline

**DORMA**

**KTC-3**

**KTC-4**



## Contemporary elegance for the perfect entrance solution – DORMA Comfortline revolving doors

Wherever central entrances of buildings have to handle heavy traffic volumes, where ease of use is paramount and where architecturally refined façades require an equally attractive complement, the DORMA Comfortline range of revolving doors provides the perfect answer.

**Superb user convenience**  
KTC revolving doors are characterised by their especially generous diameters – ranging from 3,600 to 6,200 mm. The automatic program modes can be selected in accordance with usage requirements. This ensures optimum ease of use with access effectively aligned also to the requirements of disabled users. Even the high

throughput volumes that can occur in peak traffic periods are handled by these doors without difficulty. In addition, the breakout wings with their catch and pivot fittings will fold out in any position to provide a clear escape passage.

**Optimum cost efficiency**  
KTC revolving doors protect the building interior reliably against draughts, noise and dirt. The overall concept and the sophisticated detail solutions of the KTC programme contribute to the optimisation of the building energy balance. Modern safety and security aspects have been taken fully

into account. Various night shields are also available.

**Flexible design solutions**  
The design versatility and variability of the KTC range provides for enormous architectural scope. Co-ordinated materials and surface finishes enable the door to be harmonised with virtually any façade concept. The central core of the 3 and 4-wing revolving doors can also be utilised as a showcase. This means that, right at the entrance of the building, an attractive display can be provided as the first thing visitors see.

Data and features	DORMA KTC-4	DORMA KTC-3
Inside diameter in mm (D)	3600, 4200, 4800, 5400, 6200	3600, 4200, 4800, 5400, 6000
Outside diameter in mm (B)	3828, 4428, 5028, 5628, 6428	3828, 4428, 5028, 5628, 6228
Clear passage width in mm (LW) Clear escape width in mm	(see pages 6/7)	(see pages 6/7)
Clear passage height in mm (LH)	up to 4800 dia.: 2200-2500; from 5400 dia.: 2200	up to 4800 dia.: 2200-2500; from 5400 dia.: 2200
Canopy height in mm	410-700	410-700
Total height in mm (H)	up to 3200	up to 3200
Side wall glazed	○	○
Side wall with metal panelling	○	○
Suitable for emergency exit and escape routes	●	●
Floor ring	●	●
Floor mat	○	○
6 or 8 downlights	8 downlights	6 downlights
Preparation for rainproof roof	○	○
German type approval	●	●

● Yes ○ Option

Traffic capacities				
	Theoretical capacity <sup>1)</sup>	Practical capacity <sup>2)</sup>		Maximum capacity <sup>3)</sup>
Inside diameter (D) in mm	Persons/hour →	→ Persons/hour ↔	↔ Persons/hour ←	Persons/min. →
<b>KTC-4</b>				
3600	2592	864	1728	43
4200	3312	1104	2208	55
4800	3840	1280	2560	64
5400	4320	1440	2880	72
6200	5208	1736	3472	86
<b>KTC-3</b>				
3600	2916	972	1944	48
4200	3312	1104	2208	55
4800	4320	1440	2880	72
5400	4536	1512	3024	75
6000	5184	1728	3456	86

<sup>1)</sup> The theoretical capacity value indicates how many people can pass through the revolving door in one (→) direction per hour, assuming that the traffic flow is uniform and the internal segments are fully occupied.

<sup>2)</sup> The practical capacity values indicate how many people can actually pass through the revolving door in one (→) and in both (↔) directions.

<sup>3)</sup> The maximum capacity value indicates how many people can pass through the revolving door in one direction (→) per minute when there is a constant stream of traffic, e.g. in the morning and evening.

### Plus points

#### ... for the installer

- Comprehensive range that also includes solutions suitable for sophisticated and prestigious entrances.
- Trouble-free installation and commissioning.
- Advanced technology conforming to all relevant national and international standards.

#### ... for the architect/specifier

- The sheer range of KTC system components ensures a high degree of design flexibility.
- Problem-free adaptability to individual requirements.
- Visually, technically and economically convincing solution.

#### ... for the user

- Exceptional convenience.
- Outstanding safety features.
- Tailored integrated solution of industrial engineering precision and assured manufacturing quality.
- Optimisation of building energy balance and workplace environment.

















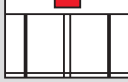





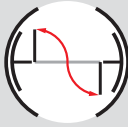

Type-approved by the Technischer Überwachungsverein Hannover to VDE 0700 T 238 and ZH 1/494 - Code of practice for power-operated windows, doors and gates.



Quality assured manufacture to DIN ISO 9001, EN 29001, BS 5750. Certified and verified by BSI Quality Assurance Reg. No. Q 6423, FM 10756



## Designs, functions, standard equipment, optional extras

Models	KTC-4/0	KTC-3/0	KTC-2/0
			
<b>Operator types</b>			
<b>Ceiling-integral drive unit</b>			
<b>Automatic</b>			
I: Door starts and stops automatically. II: Door rotates continuously at low speed which is increased as soon as a user approaches the door.	 	 	 
<b>Speed reduction feature</b> decreases the speed to approx. 2 rpm (see page 11), e.g. for senior citizens, disabled persons			
<b>Configurations</b>			
<b>Summer configuration</b> Also ideal for the passage of bulky items or luggage, and for consignment deliveries			
<b>Emergency escape configuration</b>			
<b>Options</b>			
<b>Manually or electrically locked wings</b>			
<b>Sliding night shields, internal</b>			
<b>Sliding night shields, external</b>			
			For 2-wing revolving doors, see the DORMA KTC-2 brochure

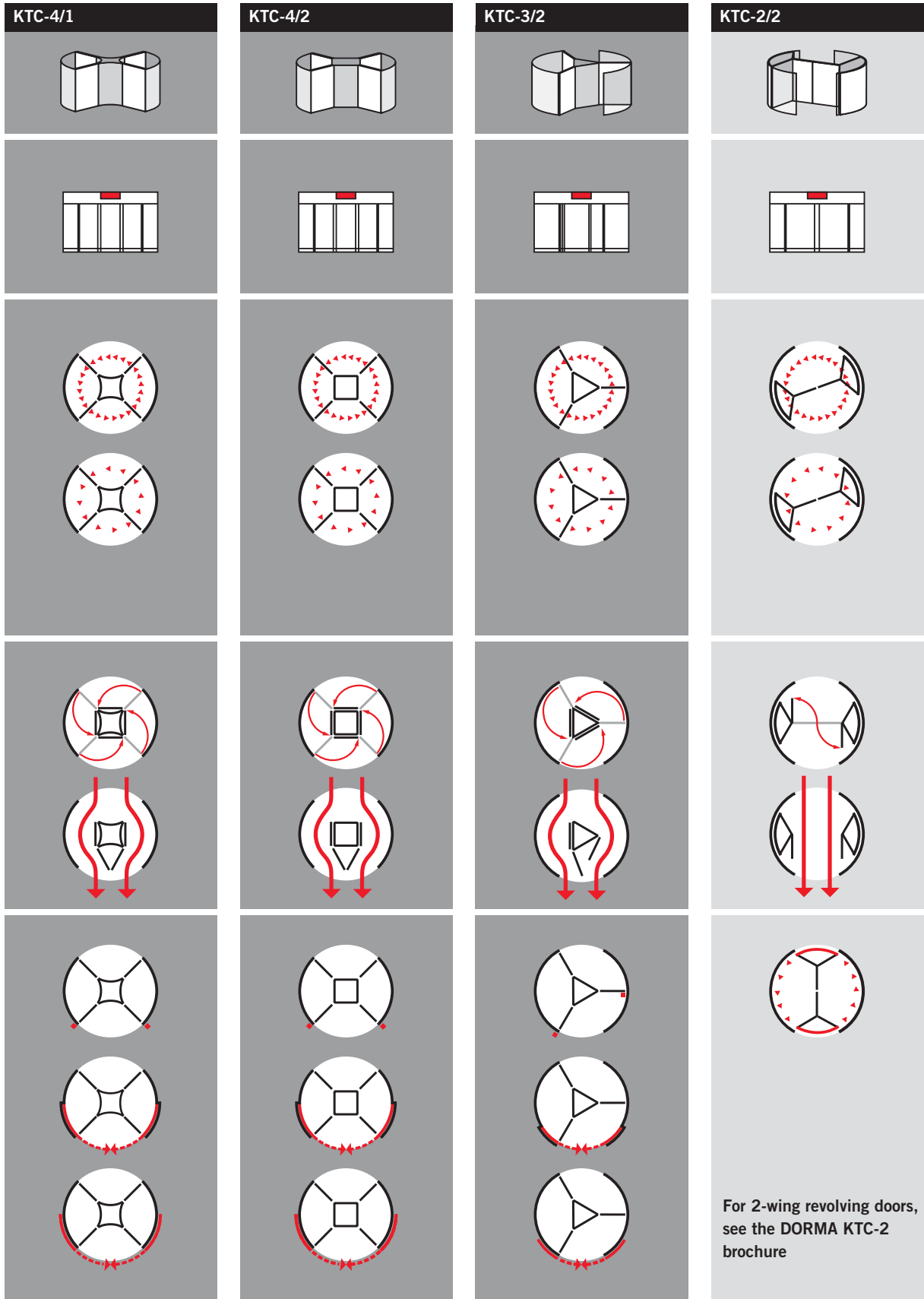

**Four-wing design**

DORMA KTC-4 Comfortline revolving doors are available in 5 standard sizes. The 4-wing revolving doors are available with various accessories. The breakout wings with their catch and pivot fittings are equipped with horsehair brushes in order to ensure the reliable exclusion of draughts in the entrance area.

**Central part versions**

- Without showcase
- With straight glass panel showcase
- With curved glass panel showcase

**Drum wall versions**

- Without night shield
- With manually operated external night shield
- With manually or electrically operated internal night shield

**Dimensions, KTC-4**

Inside diameter (D)	3600	4200	4800	5400	6200
Outside diameter (B1)	3692	4292	4892	5492	6292
Outside diameter (B2)	3828	4428	5028	5628	6428
Clear passage width (LW)	2466	2891	3315	3740	4305
Escape passage width	896	1066	1236	1406	1633
Clear passage height (LH)	up to 2500*		up to 2200*		
Total height (H)	up to 3200*		up to 2900*		
Canopy height (SH)	410 to 700*				

All dimensions in mm. \* Other heights on application.

**Plan view, KTC-4**

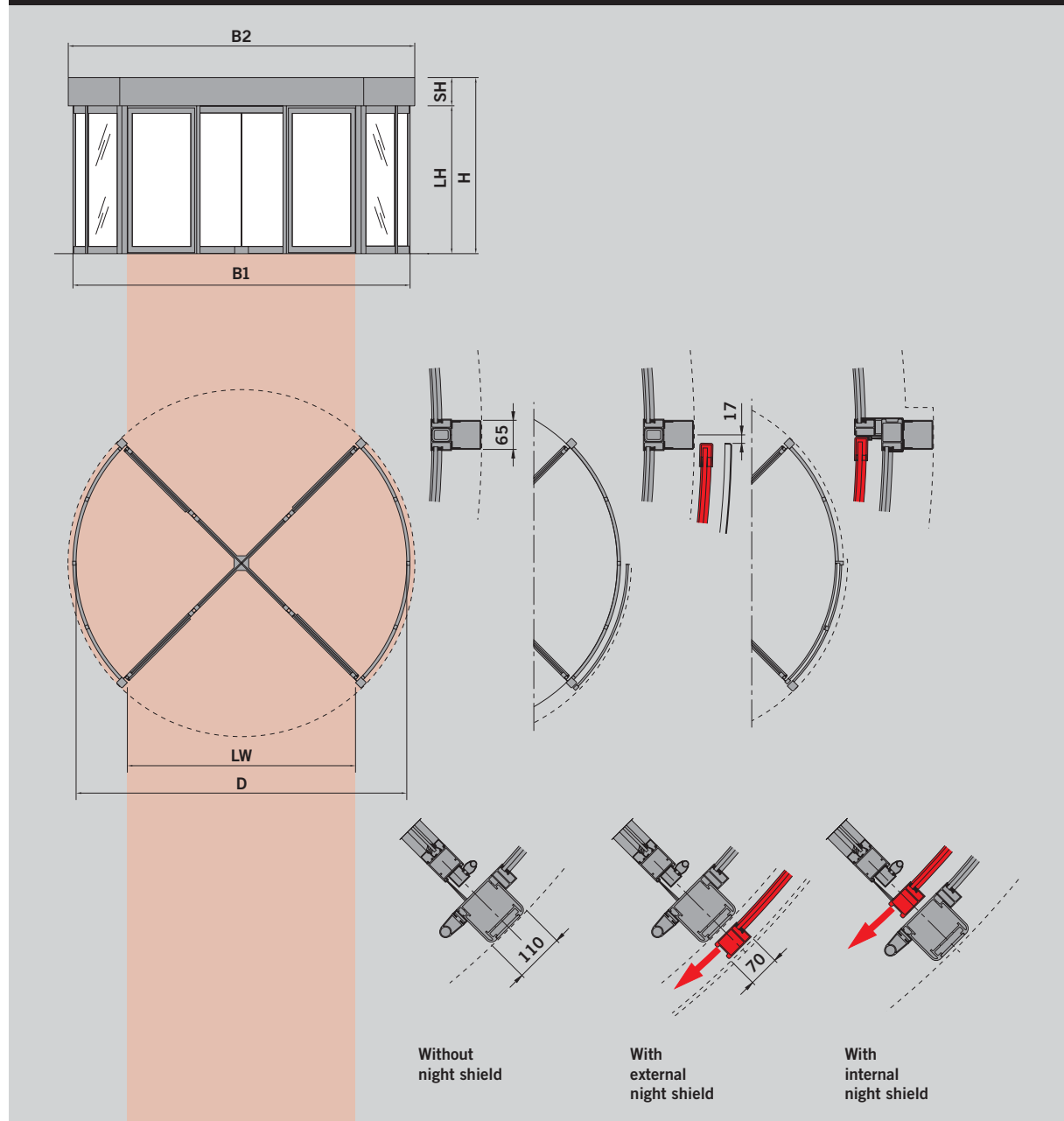

**Three-wing design**

DORMA KTC-3 Comfortline revolving doors are available in 5 standard sizes. The 3-wing revolving doors are available with various accessories. The breakout wings with their catch and pivot fittings are equipped with horsehair brushes in order to ensure the reliable exclusion of draughts in the entrance area.

**Central part versions**

- Without showcase
- With straight glass panel showcase

**Drum wall versions**

- Without night shield
- With manually operated external night shield
- With manually or electrically operated internal night shield

**Dimensions, KTC-3**

Inside diameter (D)	3600	4200	4800	5400	6000
Outside diameter (B1)	3692	4292	4892	5492	6092
Outside diameter (B2)	3828	4428	5028	5628	6228
Clear passage width (LW)	1645	1945	2245	2545	2845
Escape passage width	986	1186	1386	1586	1786
Clear passage height (LH)	up to 2500*			up to 2200*	
Total height (H)	up to 3200*			up to 2900*	
Canopy height (SH)	410 to 700*				

All dimensions in mm. \* Other heights on application.

**Plan view, KTC-3**

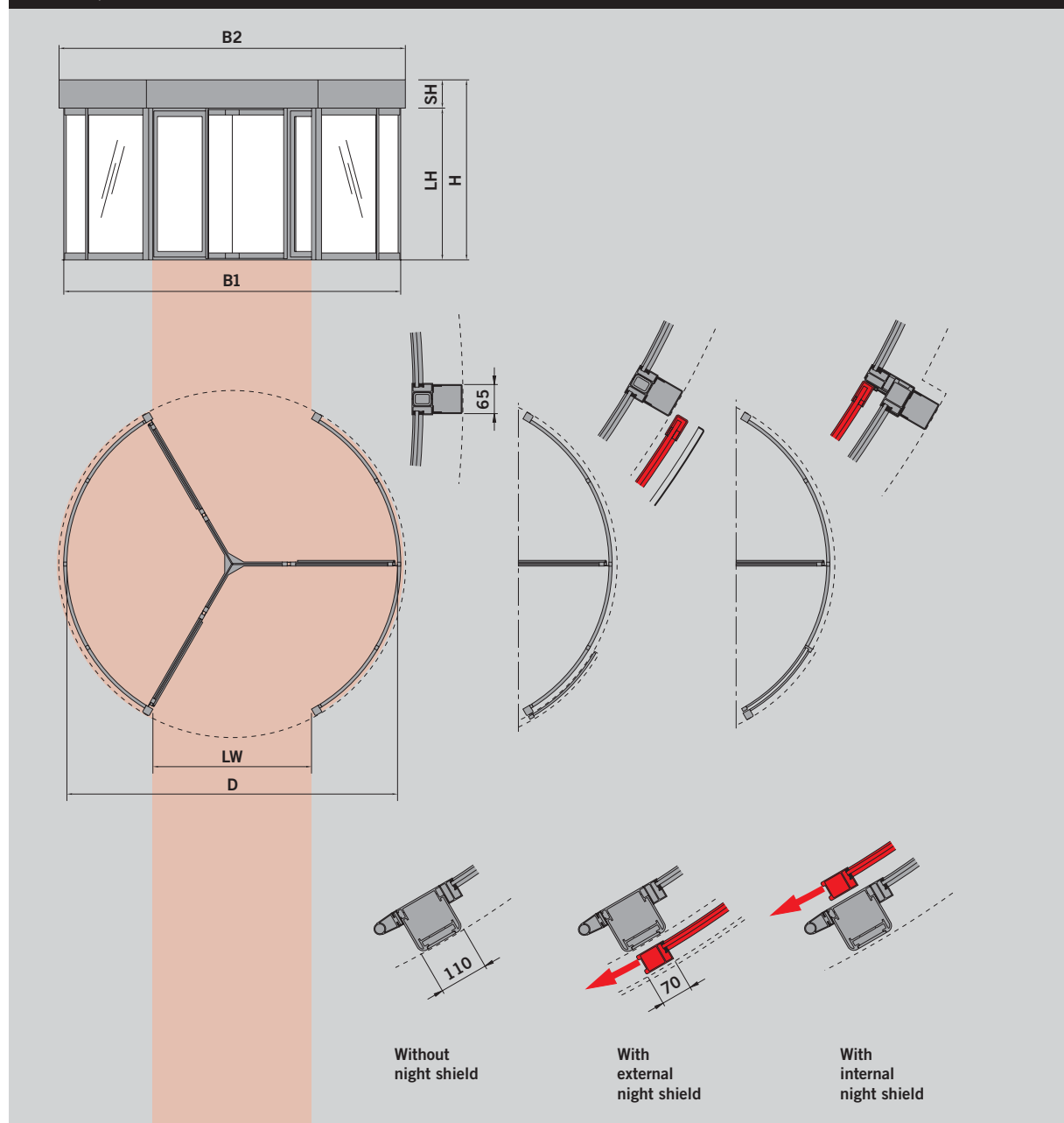

## The perfect solution for high user convenience

Aside from a range of dimensions, the KTC series also offers numerous application-aligned versions to suit individual requirements.

- KTC-3/0: Version with 3-wings and standard core
- KTC-3/2: Version with 3-wings and central showcase with straight glass panels
- KTC-4/0: Version with 4-wings and standard core
- KTC-4/1: Version with 4-wings and central showcase with curved glass panels
- KTC-4/2: Version with 4-wings and central showcase with straight glass panels
- Drum walls glazed or with optional metal panelling
- Additional manual or electrically operated night shields as optional extras.

Vertical section

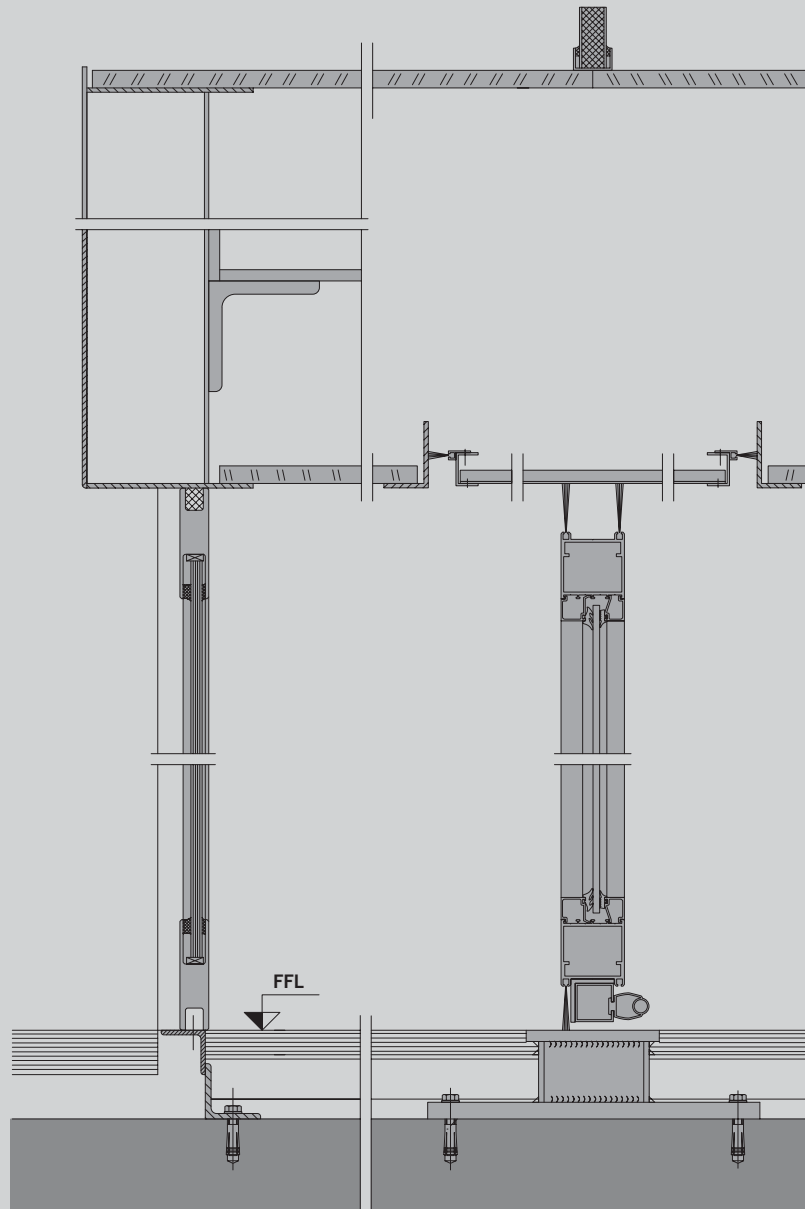



Vertical sections

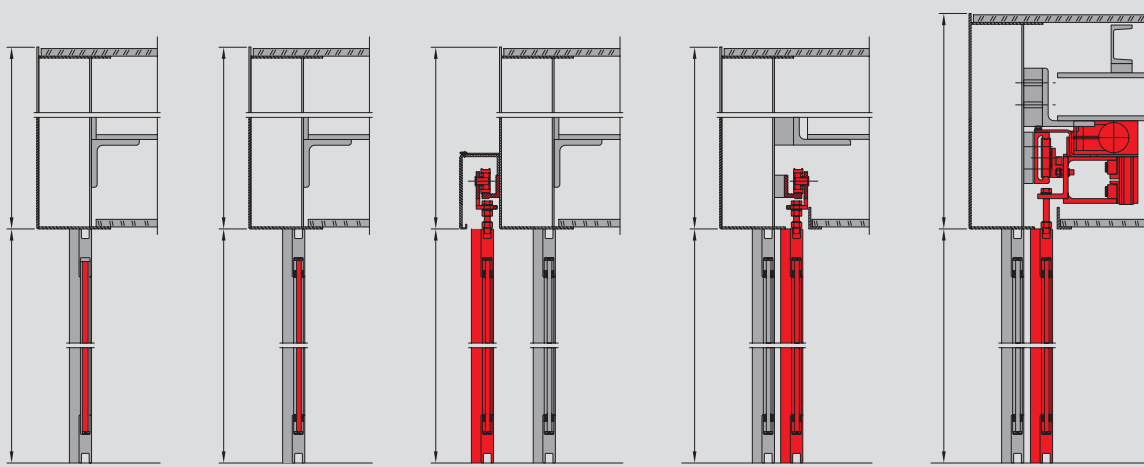

Drum wall with metal panelling

Drum wall with glazing

Additional external manual night shield

Additional internal manual night shield

Additional electrically driven internal night shield

Central part, KTC-4

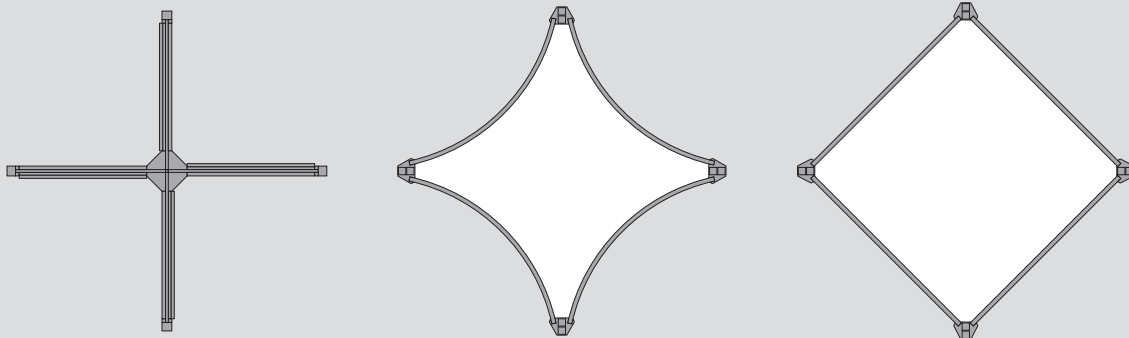

Without showcase (version 0)

With curved showcase glazing (version 1)

With straight showcase glazing (version 2)

Central part, KTC-3

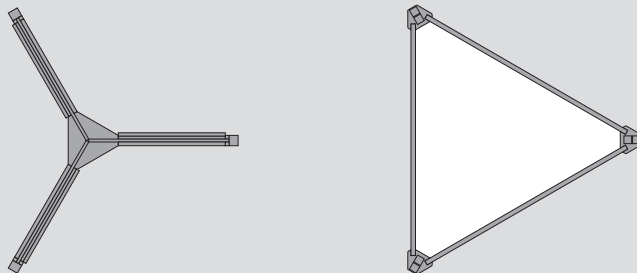

Without showcase (version 0)

With straight showcase glazing (version 2)

Floor rings

Diameter in mm	3600	4200	4800	5400	(6000 <sup>1)</sup> )	(6200 <sup>2)</sup> )
Sub-floor to FFL (A) in mm	70-250					
Nominal radius (R) in mm	1800	2100	2400	2700	3000	3100
Floor mat (C) in mm	up to 30					

<sup>1)</sup> KTC-3 only

<sup>2)</sup> KTC-4 only

Floor ring, KTC-3/KTC-4

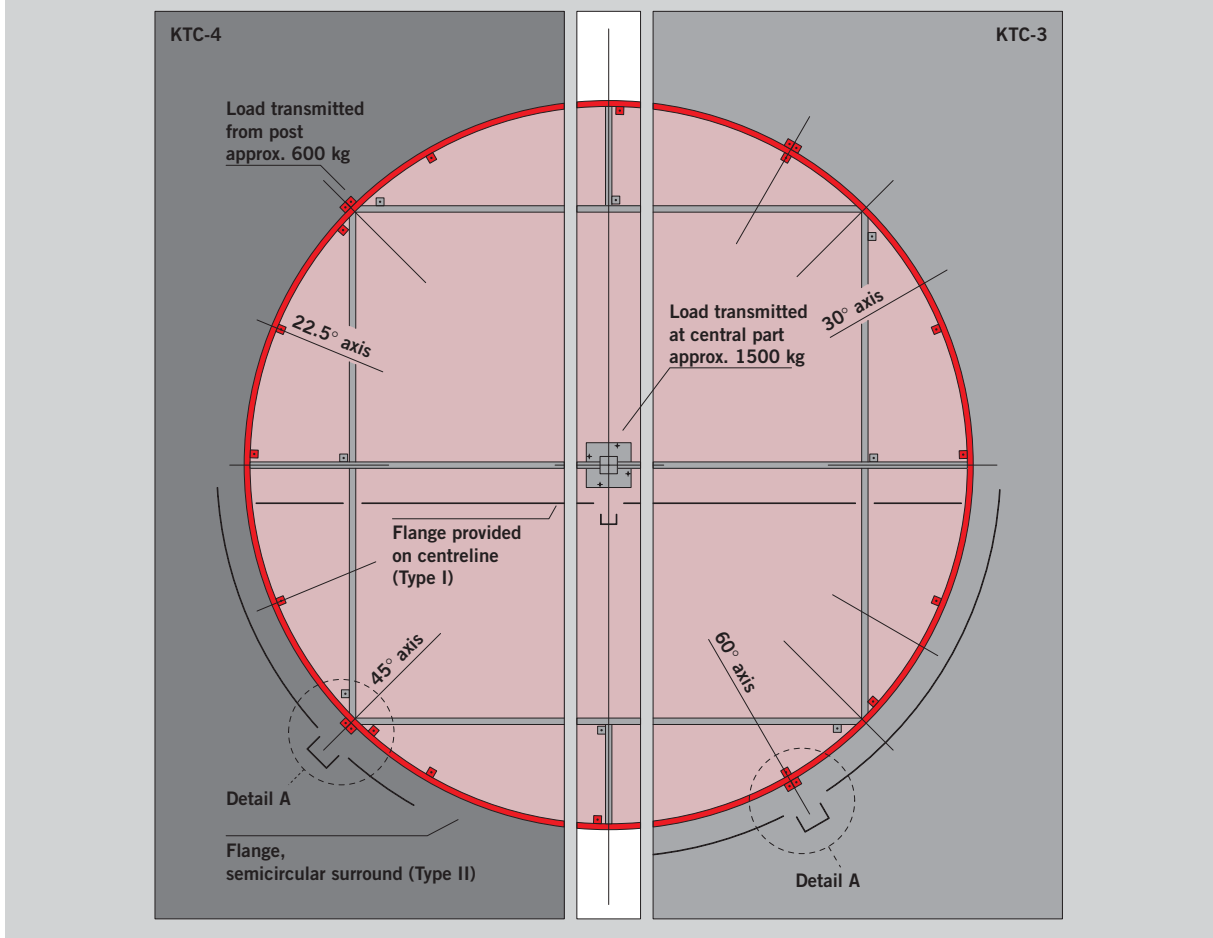

Detail A

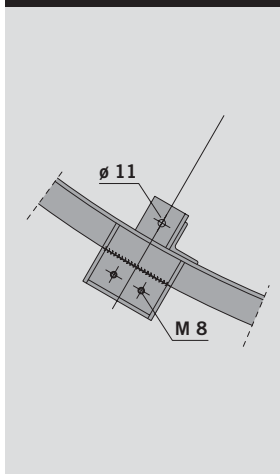

Cross sections

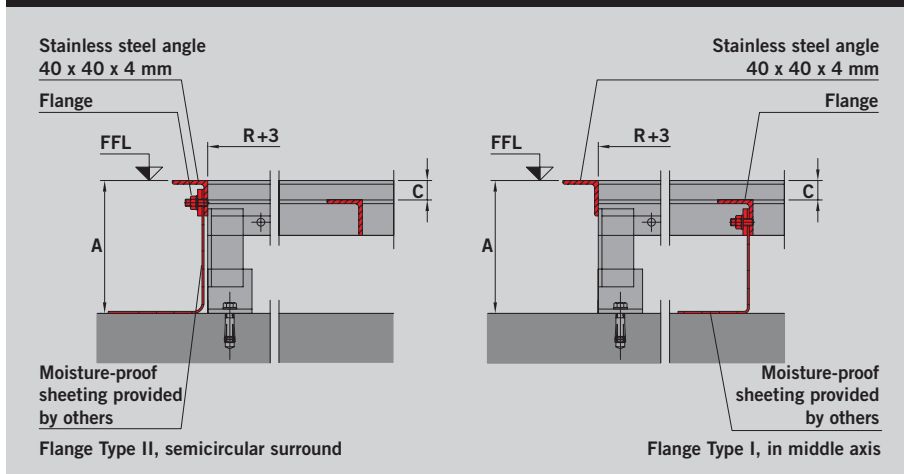

**Safety equipment**

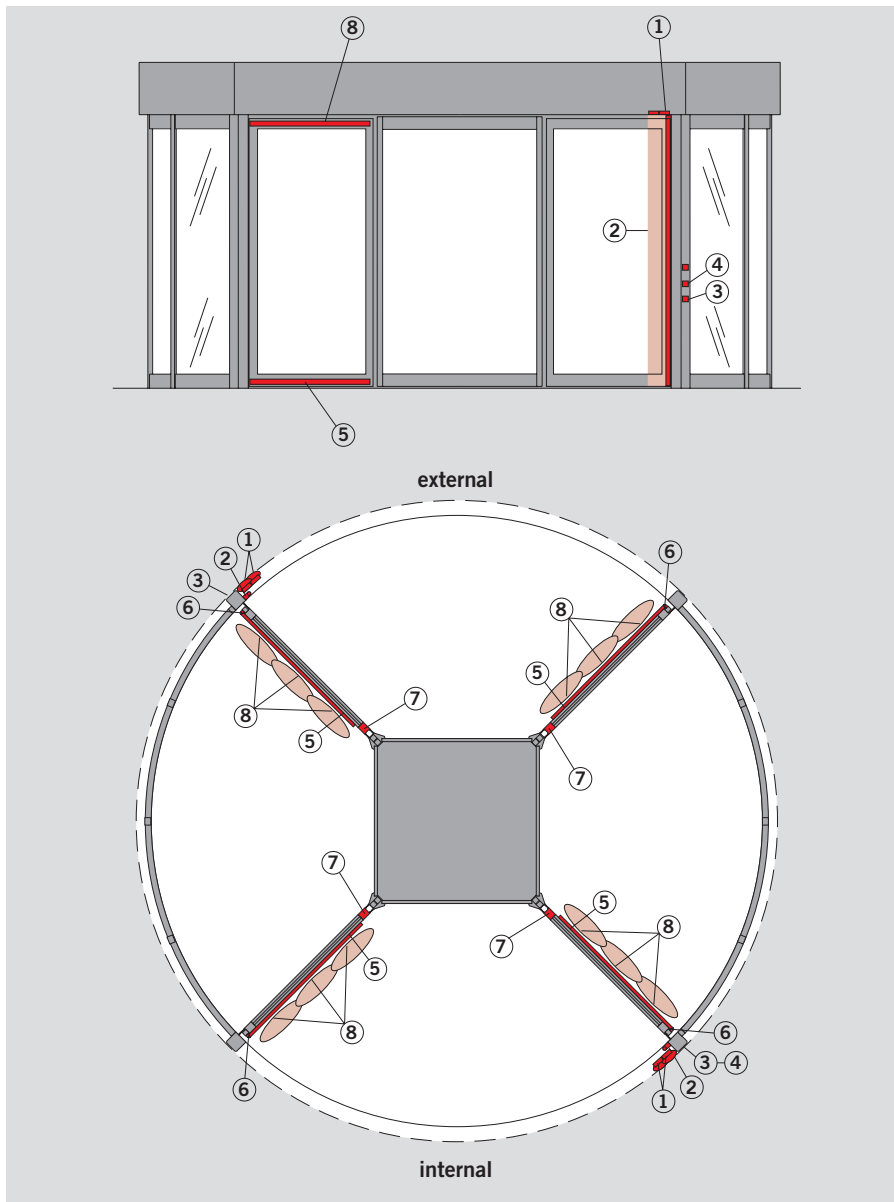

DORMA KTC-3/KTC-4 revolving doors offer a comprehensive range of safety equipment to ensure optimum protection of people and objects as they pass through the entrance/exit system. The main closing/shear edges are each equipped with two infra-red detectors and a safety contact strip. As a wing arrives at a point 500 mm from the upright post at the end of the drum wall, the infra-red light detectors and the contact strips on the post are activated. The outer edges and the bottom edges of the wings are likewise protected by safety contact strips. In addition, the wings fold on contact. As an optional extra, sensors can be provided on the top wing profile to protect the space in front of the wing.

- ① Canopy sensors, 2 x 2 infra-red detectors
- ② Post sensors in the form of 2 contact strips
- ③ Disabled access push-buttons, inside and out
- ④ Emergency stop push-button, inside
- ⑤ Contact safety strip, wing bottom, horizontal
- ⑥ Contact safety strip, wing, vertical
- ⑦ Limit switches, wings
- ⑧ Wing top sensors, horizontal (optional extra)

**Electrical cabling**

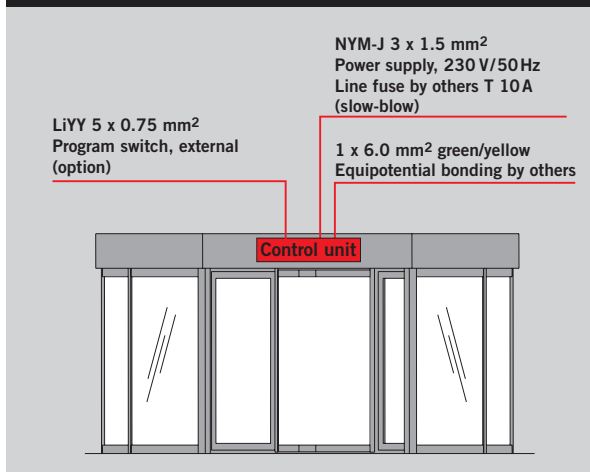

**Automatic modes / Speed reduction feature**

- The automatic control system offers two operating modes:
  - “Automatic I” – The stationary door is activated as soon as a user approaches. Following an adjustable time, it stops again at its starting position.
  - “Automatic II” – The door rotates continuously at approx. 1 rpm. As a user

enters the detection range, the speed is increased to approx. 3 rpm. Once the user has left the detection range, the speed of the door is reduced again.

- The speed reduction feature is activated by means of a special push-button to reduce the speed of the door during passage to approx. 2 rpm.

### Specification text

#### DORMA KTC revolving door

Typ KTC-3/0	<input type="checkbox"/>	3-wing without showcase
Typ KTC-3/2	<input type="checkbox"/>	3-wing with straight showcase glazing
Typ KTC-4/0	<input type="checkbox"/>	4-wing without showcase
Typ KTC-4/1	<input type="checkbox"/>	4-wing with curved showcase glazing
Typ KTC-4/2	<input type="checkbox"/>	4-wing with straight showcase glazing
Outside diameter (B2)	.....	mm
Inside diameter (D)	.....	mm
Clear passage height (LH)	.....	mm
Canopy height (SH)	.....	mm
Total height (H)	.....	mm

#### Surface finish

- PU-coated to RAL .....
- Anodised in shade E6/ .....
- Stainless steel 1.4301, 240 grit
- Stainless steel 1.4301 polished
- Brass MS 63, mill bright

### Constructional description

#### Drum walls

Curved drum walls, 46 mm thick, posts 110 x 110 mm, sockets top and bottom 100 mm high. Prepared for 24 mm wide drumwall-to-structure connection panel at door centreline.

- Glazing of 9.3 mm laminated safety glass, type GH, clear.
- Metal panelling, 18 mm thick, matching surface finish.

#### Canopy

All-aluminium support structure, welded. Upper and lower ceiling sections of white melamine-laminated chipboard. Canopy of curved aluminium sections.

#### Central part

Steel support structure with folded sheet panelling of matching surface finish. Glazing of 6 mm toughened safety glass (for straight-glazed showcase); 9.3 mm laminated safety glass, type GH (for curved-glazed showcase) or with 10 mm toughened safety glass (without showcase).

#### Wings

Special frame profiles, 57 mm deep, fair face width 80 mm, with replaceable horsehair brushes. 6 mm toughened safety glass. The wings are provided with catch and pivot fittings.

### Functional description

#### Program switch settings:

##### Automatic I

The stationary door is activated as soon as a user approaches. Following an adjustable time, it stops again at its starting position.

##### Automatic II

The door rotates at approx. 1 rpm and is accelerated to walking speed by an activator on detection of a user approaching.

##### Stop

The door stops at its home position unless the activators/detectors have been initiated again.

##### Locked

The door rotates to its home position and can be manually locked there; this also switches off the lighting.

##### Speed reduction feature

Activation of the disabled access pushbutton decreases the door speed to 2 rpm. After an adjustable time, the door returns to 3 rpm if still in use, or 1 rpm if there is no user present.

##### Escape configuration

The door leaves can be broken out and folded to an escape configuration with the door in any position. This function also remains intact in the event of a power failure or drive unit seizure.

##### Summer configuration

All 3 or 4-wings can be folded out and locked to the left and right of the central part to allow free access.

#### Options

- External night shield, manual
  - 9.3 mm laminated safety glass, type GH, clear
  - Metal panelling, 18 mm thick, matching surface finish
- Internal night shield, manual
  - 9.3 mm laminated safety glass, type GH, clear
  - Metal panelling, 18 mm thick, matching surface finish
- Electrically operated night shield (internal night shield only, max. 4800 mm)
  - 9.3 mm laminated safety glass, type GH, clear
  - Metal panelling, 18 mm thick, matching surface finish
- Mechanical wing locking
- Mechanical night shield locking
- Electric wing locking
- Electric night shield locking
- Wind brake
- Emergency power supply module
- Midrail in the door wings
- Midrail in the side walls (glazed)
- Floor ring
- Floor mat
- Downlights (max. 12)
- Prepared for rainproof roof

#### DORMA UK Limited

Wilbury Way  
Hitchin  
GB-Hertfordshire SG4 0AB  
Tel. +44 14 62/47 76 00  
Fax +44 14 62/47 76 01

#### DORMA Door Controls Pte. Ltd.

No. 2, Jalan Terusan, Jurong  
Singapore 619285  
Rep. of Singapore  
Tel. 0065 2687633  
Fax 0065 2657914

#### BWN Industries Pty. Ltd.

46 Abbott Road  
Hallam Victoria 3803  
Australia  
Tel. 0061 3/97 96 41 11  
Fax 0061 3/97 96 37 67

#### DORMA Door Controls Pty. Ltd.

P.O. Box 1092  
Narre Warren Vic 3805  
52 Abbott Road  
Hallam Victoria 3803  
Australia  
Tel. 0061 3/97 96 35 55  
Fax 0061 3/97 96 39 55

#### DORMA Gulf Door Controls FZE

Jebel Ali Free Zone, Roundabout 8,  
Unit VC 02  
P.O. Box 17268  
Jebel Ali, Dubai  
United Arab Emirates  
Tel. 00971 48 /83 90 14  
Fax 00971 48 /83 90 15

#### DORMA Door Controls (Pty.) Ltd.

Kings Court  
P.O. Box 82182  
2135 Southdale · South Africa  
Tel. 0027 11/8 30 02 80  
Fax 0027 11/8 30 02 91

#### DORMA GmbH + Co. KG

P.O. Box 40 09  
58247 Ennepetal  
Breckerfelder Straße 42-48  
58256 Ennepetal  
Germany  
Tel. +49(0)23 33/7 93-0  
Fax +49(0)23 33/79 34 95

The address of a subsidiary/  
representation in your area you can  
find at the DORMA-website:  
[www.dorma.com](http://www.dorma.com)