

CATERING SINK: E20603R

E20603R | 2000100103

ARTICLE GROUP : E20603 ++ | ARTICLE FAMILY : Catering sinks | PRODUCT GROUP : Catering

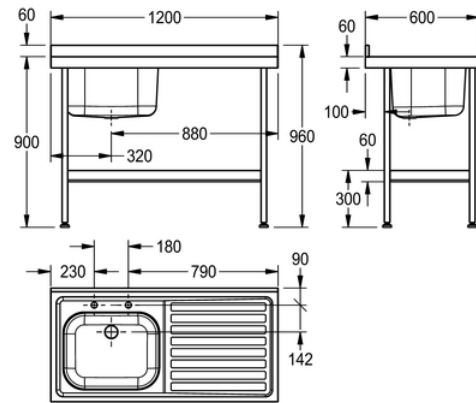

Mini sinks are manufactured from 1.2mm thick austenitic grade stainless steel polished to a satin finish. Single bowl sinks are all supplied with 38mm waste, plug, chain and overflow. Single bowl sinks have two holes drilled at 180mm centres suitable for either 13mm pillar taps or mixer taps. An earthing lug is fitted under the drainer. Stainless steel underframes complete with shelf are to be ordered as an extra part and are supplied in a flat pack form with easy to read assembly instructions. Each leg is fitted with an adjustable foot (-20, +10mm) with a working height of 900mm.

RH Single drainer

TECHNICAL DATA

bowl - bowl depth	300.00 mm
bowl finish	satin finished
bowl - depth	500.00 mm
bowl - width	400.00 mm
drainer position	right
drainer or storage	drainer
gross weight	14.30 kg
material	stainless steel
material code	1.4301 Chrome Nickel steel V2A
material thickness	1.20 mm
overall depth	600.00 mm
overall height	900.00 mm
overall width	1,200.00 mm
rear upstand	yes
surface finish	satin finished
tap ledge	yes
type of mounting	floor mounting
waste hole position	right back corner
waste hole projection	222.00 mm
waste size	DN 40
net weight	14.30 kg

CATERING SINK: E20603R

E20603R | 2000100103

ARTICLE GROUP : **E20603 ++** | ARTICLE FAMILY : **Catering sinks** | PRODUCT GROUP : **Catering**

ACCESSORY



TAP: F1026

2000100345



TAP: F1081

2000100388



TAP: F1083

2000100389

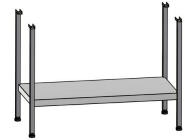

UNDERFRAME

2000100525

RECOMMENDED PRODUCT

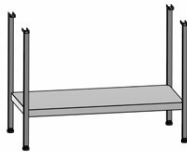

UNDERFRAME

2000100525
