



Rely on it.

Lightweight but very strong.

RENOLIT ALKORSOLAR

A high-angle photograph of a white roof covered with a grid of dark solar panels. The sun is visible in the upper left, creating a lens flare effect. The panels are arranged in a neat, repeating pattern.

EXCELLENCE
IN ROOFING



The only 5-in-1 solution for securing solar panels.

RENOLIT ALKORSOLAR

The fixing system of choice for flat and pitched roofs.

Wind removed solar panels, damaged waterproofing, penetrating moisture and increased weight due to ballast. Just some of the adverse effects of poorly fitted solar panels. A specifier, roofing contractor or installer of solar panels you would not wish to see damage claims of this kind.

RENOLIT ALKORSOLAR is the ideal solution for reliable and long-lasting installation of solar panels on synthetic roofs. Over ten years of experience without failure are proof of this!

Independent wind tunnel tests and controls make it abundantly clear: with RENOLIT ALKORSOLAR you opt for safety and quality! Whilst complaints are common for alternative systems, RENOLIT provides a wind-proof and totally watertight solution. Many architects, solar installers and roofing contractors are already convinced.

Discover 5 significant reasons for choosing RENOLIT ALKORSOLAR.

- 1

Lightweight but very strong.

100% secure, hot-air welded fixing system and **no additional ballast.**

p9
- 2

Fully watertight.

Installation of solar panels on synthetic roofs **without perforating** the waterproofing.

p12
- 3

Quick and easy to install.

Simple installation and suitable for all types of PV and solar thermal systems.

p14
- 4

Easy to maintain.

All elements are **easily accessible** for maintenance

p18
- 5

Surprisingly versatile.

Suitable for new or existing roofs with **PVC-P** or **EVA** roofing membranes, for bonded and mechanically fastened systems and ideal as a carrier system for securing façade materials such as wood or aluminium, ... on the roof.

p20

System design.

RENOLIT ALKORSOLAR

The **RENOLIT ALKORSOLAR** fastening system is suitable for all types of PV installations and provides many additional benefits. But what does this patented system actually consist of?

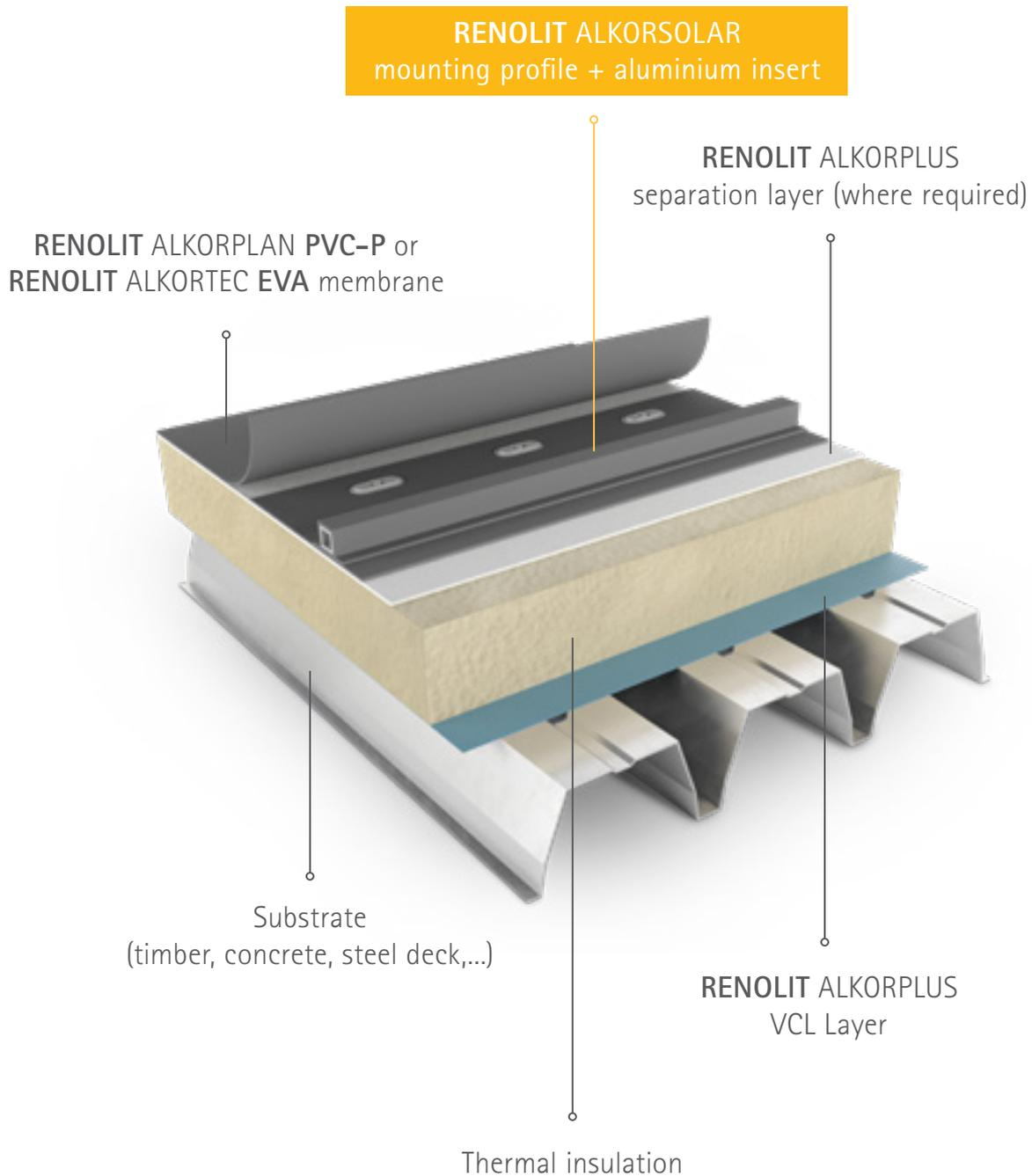

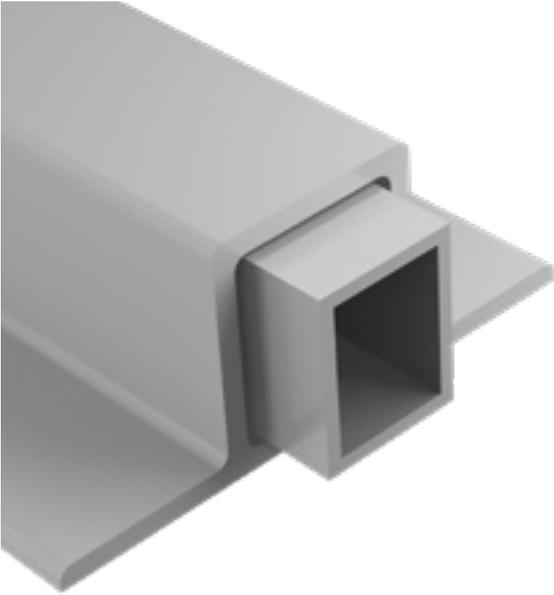

Simple and unique

The **RENOLIT ALKORPLAN** PVC-P profile, depending on the project's underlying waterproofing, forms the base of the system. Hot air welding is used to fuse the **RENOLIT ALKORSOLAR** profile to the roofing membrane for a fully integrated finish. This is the system's major strength! The profile is securely fixed in place and cannot move and is therefore unable to damage the underlying roofing membrane. The profile is also always fully compatible with the synthetic membrane below.

An aluminium box section inserted into the synthetic profile is used as a base to mechanically fasten the substructure for the panels.

This is without the slightest risk of penetrating the waterproofing membrane!

Important! For a mechanically fastened system, always ensure that the profiles are welded 5 mm adjacent to the weld seam and on **the underlying roofing membrane**.

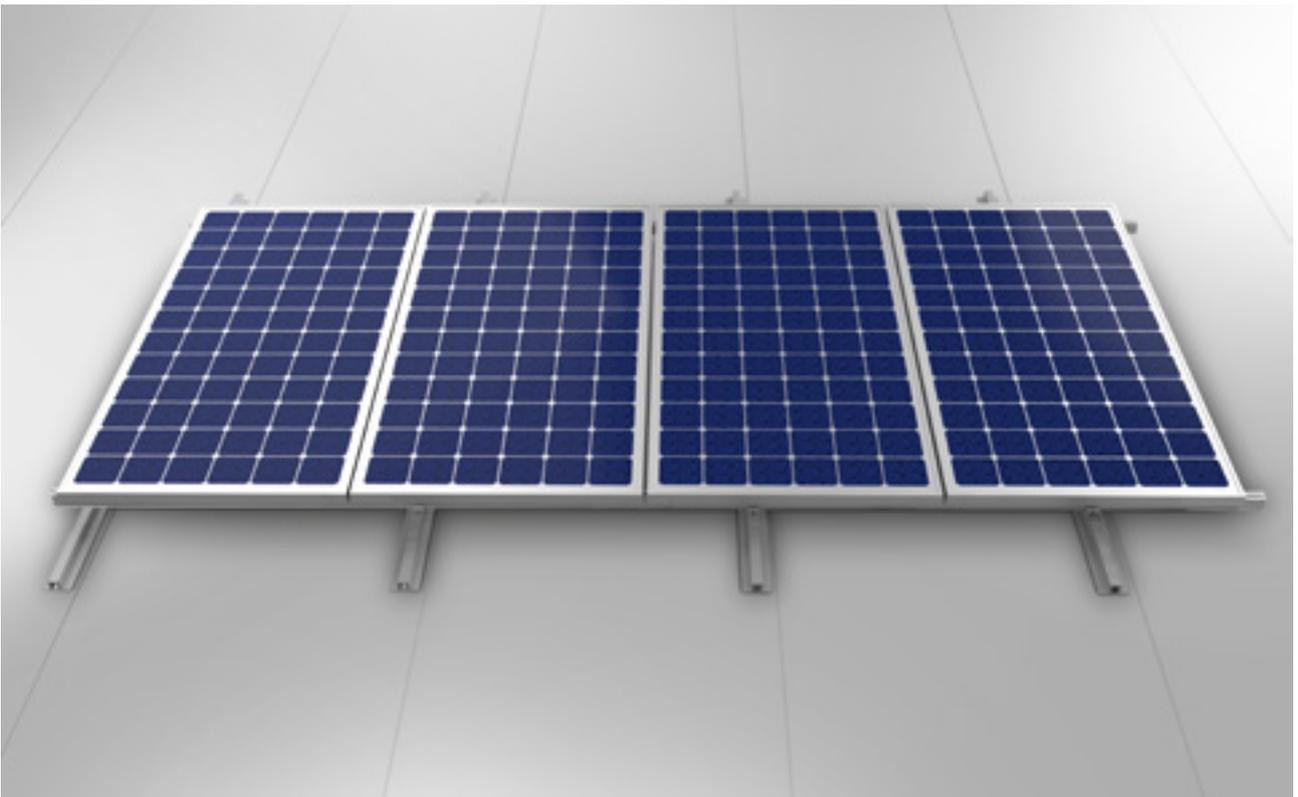

Sections of the RENOLIT ALKORSOLAR system:

1. Extruded profile: RENOLIT ALKORPLAN (PVC-P)		2. Aluminium insert: RENOLIT ALKORPLUS ₈₁₆₀₁		3. Self-tapping stainless steel fastener with bonded washer (SW8): RENOLIT ALKORPLUS ₈₁₆₀₂	
Length	3 metres	Length	3 metres	Diameter	6 mm
Basic profile	80 mm	Thickness	2 mm	Length	25 mm
Thickness PVC	3 mm	Height	25 mm	Stainless steel quality	A2
Height	33 mm	Width	20 mm		
Width	30 mm	Aluminium quality	EN6060 T6-ALMgSi 0,5 F22		

Additional accessories

4. Multifunctional mounting profile: RENOLIT ALKORPLUS ₈₁₆₃₁		5. Clamp for multifunctional profile: RENOLIT ALKORPLUS ₈₁₆₃₂		6. Interface for multifunctional profile: RENOLIT ALKORPLUS ₈₁₆₃₄	
Length	6.20 m	Length	50 mm	Length	300 mm
Height	54 mm	Aluminium quality	EN AW 6060 T66	Height	32 mm
Width	46 mm			Width	28 mm
Aluminium quality	EN AW 6063T66			Aluminium quality	EN AW 6060 T66

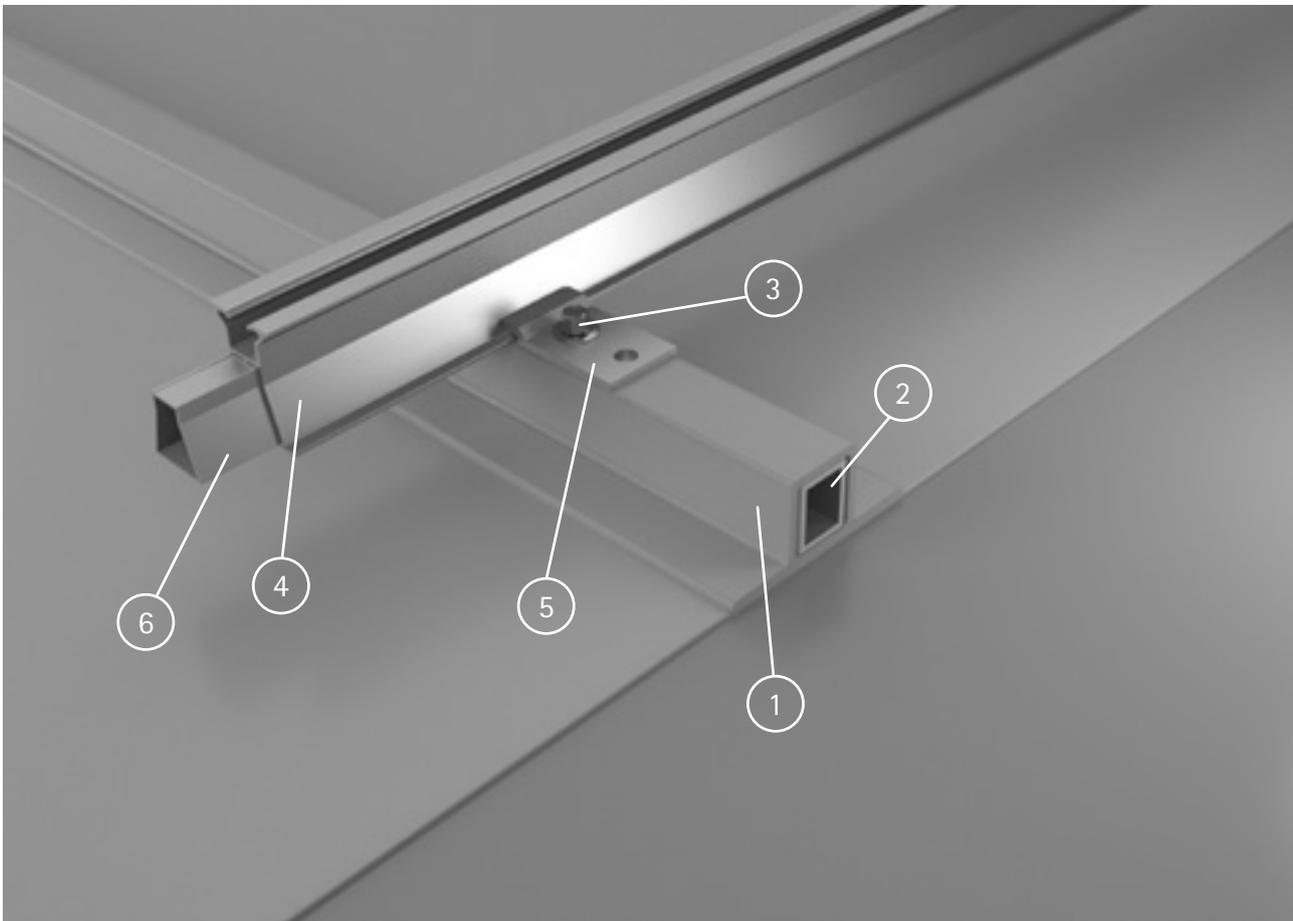

RENOLIT ALKORSOLAR sections

The RENOLIT ALKORSOLAR system as a fixing system for crystalline panels.

At present, in 90% of cases crystalline solar panels are fitted. These panels have the highest power output which makes them efficient even for smaller roof surfaces. The **RENOLIT ALKORSOLAR** system functions here as a base for the attachment of PV panels to aluminium substructure. Such aluminium structures ensure that the crystalline panels can be installed either flat or at a specific angle on the roof. For maximum solar radiation.

Tip! Increased efficiency may be achieved by applying the **RENOLIT ALKORSOLAR** system for crystalline photovoltaic elements with either brilliant white, high reflectance **RENOLIT ALKORBRIGHT** membrane or our high reflective cool grey or cool ivory **RENOLIT ALKORSMART** roofing membranes. Productivity may be increased by 4% with PV panels and 9% with solar thermal.

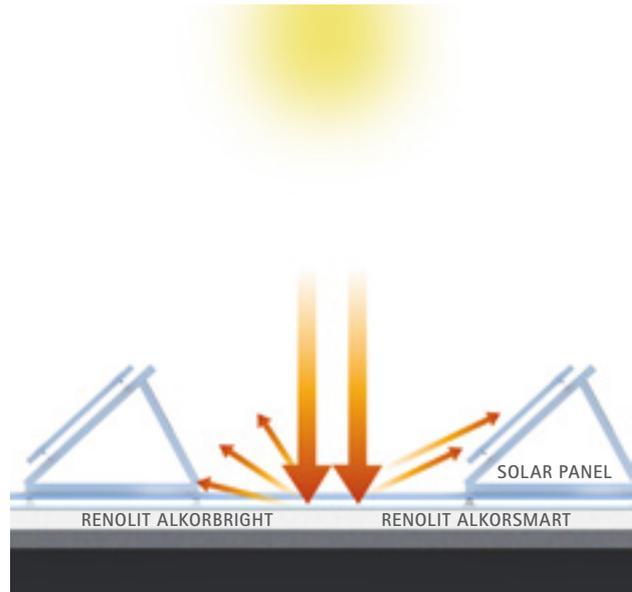

High reflectance **RENOLIT ALKORBRIGHT** roofing membranes or the **RENOLIT ALKORSMART** cool colours under the solar panels increase efficiency.





Lightweight but very strong.

RENOLIT ALKORSOLAR

For an architect it is important that the load-bearing capacity of a roof is not compromised. The addition of solar panels may bring problems. Many PV systems are weighted with ballast to prevent movement. The addition of ballast, for example 80 to 100 kg per m², can prove harmful to a roof structure and lead to serious complications and unexpected problems.

With **RENOLIT ALKORSOLAR** this problem does not occur. The synthetic profiles together with aluminium box section are very light.

Extra ballast is unnecessary since the PVC-P profiles are fused homogeneously with the roofing membrane thanks to hot air welding. This lightweight system is held securely in place and is 100% safe, even in extreme weather conditions.

RENOLIT ALKORSOLAR profiles distribute the extra weight of the PV system over the roof surface. There is no risk of point loading, damage to the waterproofing and insulation is therefore excluded.

It is a safe, lightweight system which on new build can also reduce the cost of the substructure

Please note: In addition to the weight of the PV system it is also necessary to take into account wind and snow load on the structure. A preliminary stability study is necessary.

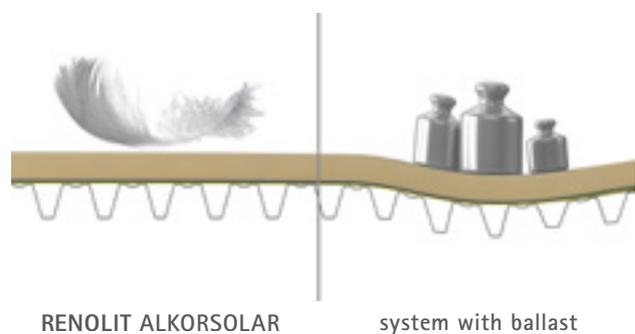

RENOLIT ALKORSOLAR is the lightweight solution

Tested at wind speeds of up to 200 km/hour..

RENOLIT ALKORSOLAR is technically proven in every aspect. During development, wind tunnel tests were undertaken at the Von Karman Institute (VKI) and tested up to a maximum of 200 km/hour (laminar). **RENOLIT ALKORSOLAR** profiles withstood the tests without any problems.

This is also proven in practice: **RENOLIT ALKORSOLAR** has been active on the market for over 10 years without the slightest issue.

... and approved.

In addition to wind tunnel tests, **RENOLIT ALKORSOLAR** has French technical approval (Avis Technique) and German DIBT approval. **RENOLIT ALKORSOLAR** is unique, being the first and only PV mounting system on the German market with DIBT approval.

Test reports and approvals are available online or on request.

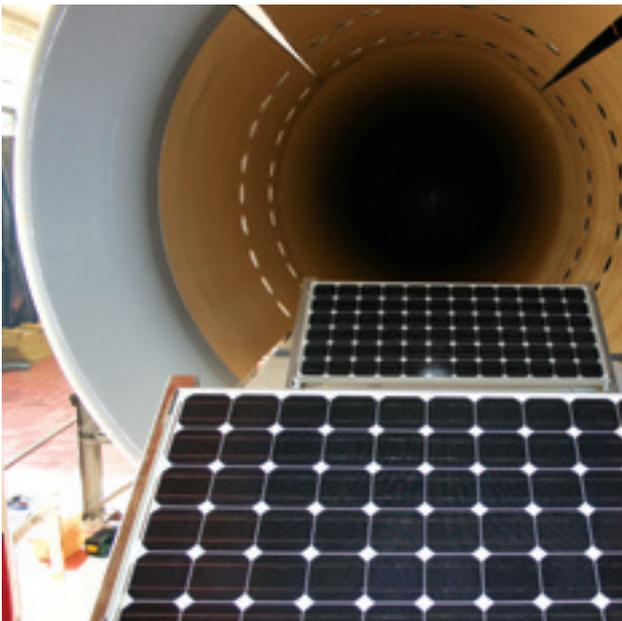

Wind tunnel test VKI







Watertight and stays watertight.

RENOLIT ALKORSOLAR

*At its height, the solar market was swamped by all kinds of inappropriate solutions for securing solar panels to roofs. With all the associated dangers. Poor installation of solar panels is often the cause of damage and subsequent leaks. The method by which solar panels are secured to a roof is therefore key. With the innovative **RENOLIT ALKORSOLAR** system safety is assured, and the roofing membrane will not be perforated.*

Result: no risk of leaks, no additional costs or damage claims!

Please note: To safeguard the integrity of the system only components purchased from **RENOLIT** Belgium can be used in the **RENOLIT ALKORSOLAR** system.





Quick and easy to install.

RENOLIT ALKORSOLAR

RENOLIT ALKORSOLAR is specially designed for quick and easy installation. The synthetic profiles are thermally fused to RENOLIT membranes and subsequently form the basis on which the multifunctional mounting profiles and finally the solar panels are secured. This is regardless of whether the panels are parallel to the roof surface or at a pitch by means of aluminium triangles. Photovoltaic elements are not directly fixed down to the roof structure, which saves a lot of time.

Hot air welding

Hot air welding of these synthetic profiles can be carried out very quickly. **RENOLIT** has developed a special **RENOLIT ALKORSOLAR** conversion kit for this purpose which may be attached on an automatic welding device. Providing a useful tool for the professional roofing contractor and making for a particular easy installation.

Are you a PV installer and not a roofing contractor?

Not a problem. When installing the **RENOLIT ALKORSOLAR** system there is no risk to the waterproofing of the roof. The PV system is simply mounted on the **RENOLIT ALKORSOLAR** system. This also means that a PV installer or roofer can continue to work using the PV system they are familiar with. Convenient and affordable!

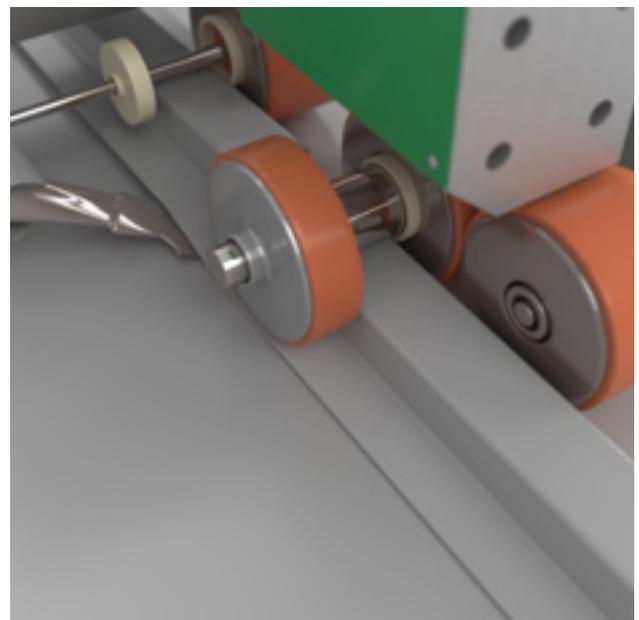

Welder with the **RENOLIT ALKORSOLAR** conversion kit

Minimum wind load

Photovoltaic elements are generally only fitted to the centre section of a roof. The corner and edge areas are not suitable because of excessive wind load.

Edge areas will only be considered if the location and height of a building meets the required standard.

In addition, the type of roof deck and façade structure are crucial. The zoning and the distance between the **RENOLIT ALKORSOLAR** profiles are determined by means of a wind load calculation.

Technical and commercial staff at **RENOLIT** will be happy to help you.

Maximum efficiency

For the output of PV panels the orientation of the building is very important. Try to avoid cast shadow of air conditioning units, skylights or even surrounding buildings because lengthy shadows can be very detrimental to the performance of the solar system. The direction of the actual PV panels is also important. It is preferable to orientate crystalline panels to the south for greatest efficiency and installed at an optimum inclination.

Depending on the orientation, slope and size of the panels a minimum spacing must be maintained. This way, cast shadow cannot substantially diminish the efficiency of the panels. Generally as a spacing 3x the height of the photovoltaic elements is used. For reasons of maintenance, it is good practise to keep clearance around skylights and air conditioning units.

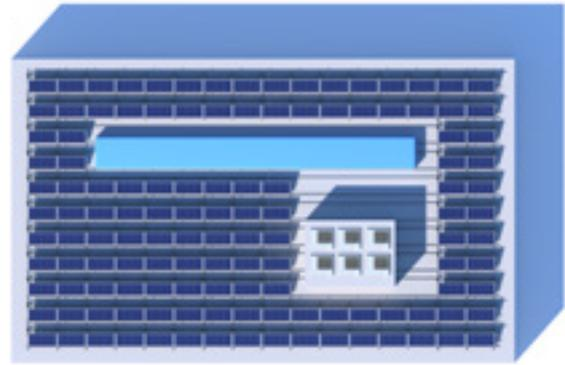

The centre section of the roof is the best place for the solar panels. No panels should be fitted in areas where shadows are cast.

Extra service

The **RENOLIT** technical team will be pleased to assist with your **RENOLIT ALKORSOLAR** project, this includes confirmation of the optimum spacing between **RENOLIT ALKORSOLAR** profiles.

Tip! Also available is the online specifications service at www.renolit.com/roofing. This handy, simple and free to use tool provides you with a ready document in a matter of clicks.

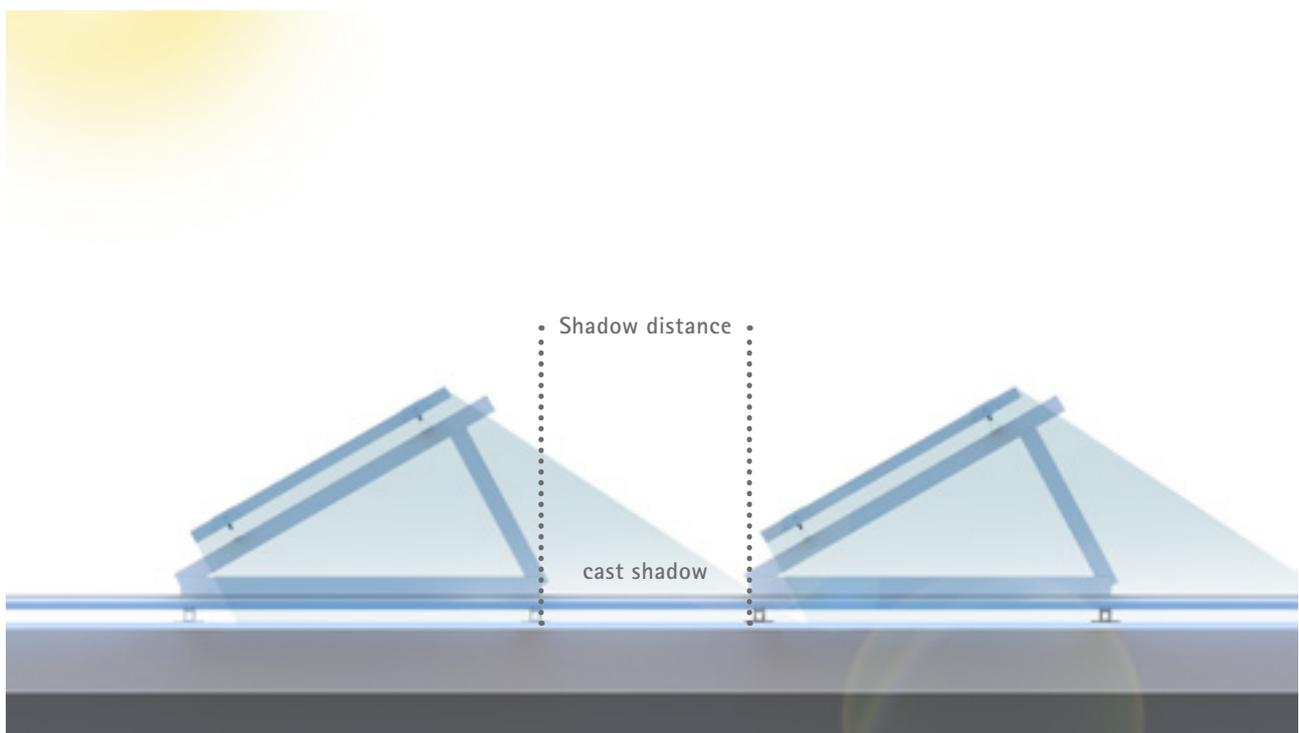

There must be a minimum distance between the panels





Flower auction building - Netherlands

Easy to maintain and repair.

RENOLIT ALKORSOLAR

*The **RENOLIT ALKORSOLAR** system stands out on account of its simplicity and reliability. If maintenance or repair work does need to be carried out, all elements of the system are easily accessible.*

Once or twice a year a maintenance check on the roof is required. Installed solar panels should not hamper this work. Thanks to the simple **RENOLIT** system, dirt that has built up on crystalline panels on an angle can easily be removed. A **RENOLIT ALKORBRIGHT** membrane under the solar installation will provide additional benefit. Grime will not stick so readily on account of the special coating and will be washed away in the rain.

Any technical intervention needed? Don't worry! If solar panels need to be replaced, this is possible with the **RENOLIT** system without the risk of damaging the waterproofing membrane. A major advantage for a PV installer as it is important for a repair to be carried out quickly and efficiently.



Replacing panels without the risk of damaging the roofing membrane.



Glasgow Fort Shopping Centre – UK

Surprisingly versatile.

RENOLIT ALKORSOLAR

*The **RENOLIT ALKORSOLAR** solution for installing solar panels or solar thermal is innovative. The many benefits serve to illustrate this. But equally important is also its wide area of application.*

The system can be installed on most synthetic roofs, PVC-P and EVA.

RENOLIT ALKORSOLAR profiles can be fitted on new build and just as easily to an existing roofing membrane. Provided, of course, that the existing waterproofing membrane is still in good condition!

And that's not all. The ingenious features of **RENOLIT ALKORSOLAR** profiles are also evident in new alternative applications for the finishing of buildings. The lightweight profiles may also be used as a carrier profile for securing cedar shingles, aluminium composite sheets, timber planking or even trellising for vegetation. Numerous beautiful aesthetic ideas demonstrate the creative possibilities. Your building gets an exclusive finishing touch with a perfect watertight guarantee.

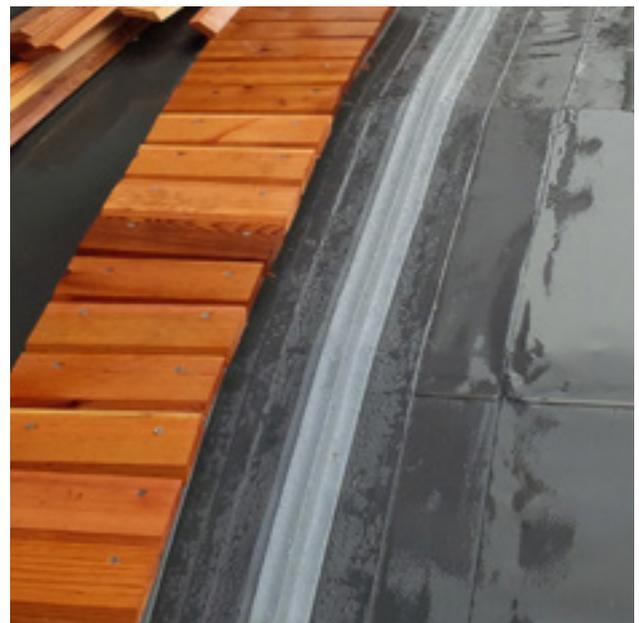

Wooden slats are secured to **RENOLIT ALKORSOLAR** profiles.

The right choice for your project.

RENOLIT ALKORSOLAR



Roof surface = RENOLIT ALKORPLAN (PVC-P) or RENOLIT ALKORTEC (EVA)

RENOLIT ALKORSOLAR can be installed in accordance with the guidelines of RENOLIT Belgium NV.

Tip:
Consider a RENOLIT ALKORBRIGHT roofing membrane under the crystalline panels. With a solar reflectance of more than 90% the use of this roofing membrane will increase considerably the output of the photovoltaic panels.



Roof surface = RENOLIT ALKORPLAN (PVC-P) or RENOLIT ALKORTEC (EVA)

YES

The roof is in good condition in accordance with the RENOLIT guidelines.*

YES NO

Is your PVC-P or EVA roof mechanically fastened?

NO YES

Special guidelines apply to a bonded system. The technical manager will be happy to help you.

A wind calculation must be undertaken. Depending on the result additional mechanical fixing may be required, sealed with cover-straps of new roof membrane.

* Thorough analysis of your roof surface is important! Let the RENOLIT team of experts help you with this.

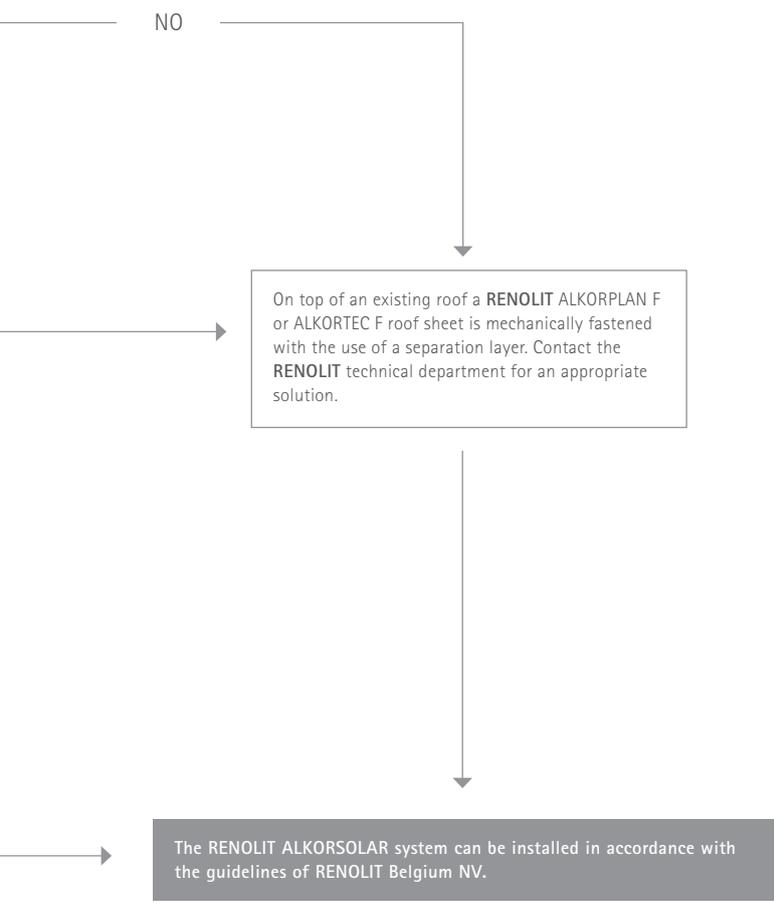



Industrial building Valéo – France
24,500 m² RENOLIT ALKORPLAN F + RENOLIT ALKORSOLAR profiles



Private residence – Belgium
RENOLIT ALKORPLAN F + RENOLIT ALKORSOLAR profiles for mounting solar thermal and solar panels

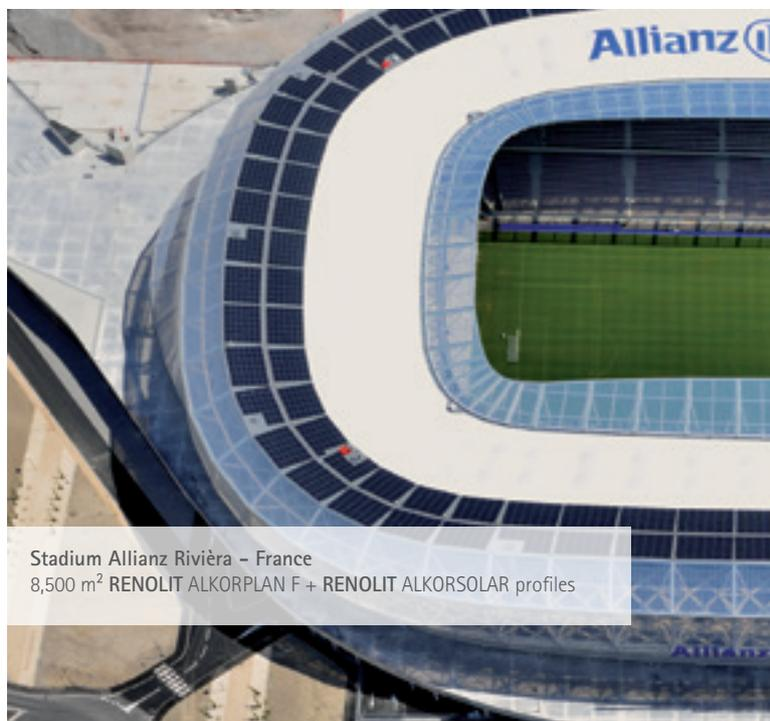

Stadium Allianz Riviera – France
8,500 m² RENOLIT ALKORPLAN F + RENOLIT ALKORSOLAR profiles

Some of our references.

RENOLIT ALKORSOLAR



Industrial building - Germany
19,935 m RENOLIT ALKORSOLAR profiles





Private residence – Belgium
RENOLIT ALKORSOLAR profiles as basis for ayous wood planking



Cemetery prayer room – United Kingdom
RENOLIT ALKORSOLAR profiles as basis for wooden tiles



Sport and recreation centre – United Kingdom
RENOLIT ALKORSOLAR profiles as basis for mounting cedar shingles and aluminium panels.



Océanopolis – France
RENOLIT ALKORSOLAR profiles as basis for aluminium sheets

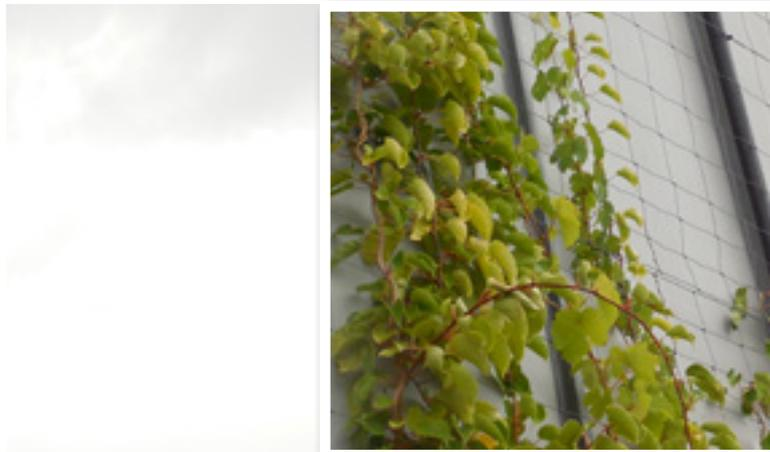

Club Kamikaze – Belgium
RENOLIT ALKORSOLAR profiles as basis for a green wall



vinyl ^{plus}



The British Board of Agrément have assessed the life expectancy of RENOLIT ALKORPLAN F used in the United Kingdom to be up to 40 years.



RENOLIT ALKORPLAN roofing products and system have a standard guarantee of 10 years, and are installed by approved contractors and installers who are trained and assessed by RENOLIT.



All RENOLIT waterproofing membranes for roofing are part of the RoofCollect® collection and recycling programme.



The only system for fixing solar panels on flat roofs that has been approved by DIBT (German Institute for Building Technology).



The RENOLIT Iberica S.A. factory in Sant Celoni (Barcelona) is approved to ISO 9001/14001.

www.renolit.com/roofing

RENOLIT Cramlington Ltd, Station Road - Cramlington, Northumberland NE23 8AQ - United Kingdom
T +44 1670 718283 - F +44 1670 719367 - renolit.cramlington@renolit.com

RENOLIT Belgium N.V. - Export Dpt. - Industriepark De Bruwaan 43 - 9700 Oudenaarde - Belgium
T +32 (0)55 33 98 51 - F +32 (0)55 31 86 58 - renolit.belgium@renolit.com

The information contained in the present commercial literature has been given in good faith and with the intention of providing information. It is based on current knowledge at the time of issue, and may be subject to change without notice. Nothing contained herein may induce the application of our products without observing existing patents, certificates, legal regulations, national or local rules, technical approvals or technical specifications or the rules and practices of good workmanship for this profession. The purchaser should verify whether import, advertising, packaging, labelling, composition, possession, ownership and the use of our products or the commercialisation of them are subject to specific territorial rules. He is also the sole person responsible for informing and advising the final end user. When faced with specific cases or application details not dealt with in the present guidelines, it is important to contact our technical services, who will give advice, based on the information at hand and within the limitations of their field of expertise. Our technical services cannot be held responsible for the conception of, nor the execution of the works. In the case of negligence of rules, regulations and duties on the part of the purchaser we will disclaim all responsibility. The colours respect the UV resistance required by EOTA, but are still subject to the natural change over time. Excluded from the guarantee: aesthetic considerations in case of partial repair of deficient membrane covered by the guarantee. The product availability differs from country to country, please refer to the RENOLIT technical department for further advice.



Rely on it.