

# ECOPHON FOCUS™ A

Ecophon Focus™ A has an exposed grid system with easily demountable tiles. For applications where a robust suspended ceiling system is required. Improves absorption in the low frequency range, Ecophon Extra Bass can be installed on top of the suspended ceiling.



# Ecophon Focus™ A

## SYSTEM RANGE



Size, mm	600x600	1200x600	1200x1200	XL 1600x600	XL 1800x600	XL 2000x600	XL 2400x600
Connect T15	•	•	•				
Connect T24	•	•	•	•	•	•	•
T24	•	•	•				
Thickness	20	20	20	20	20	20	20
Inst. Diagr.	M01, M399	M01, M399	M01	M16, M46	M16, M46	M16, M46	M16, M46

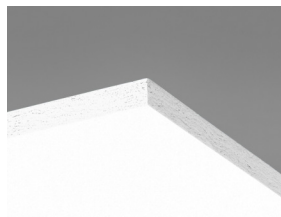

Focus A tile

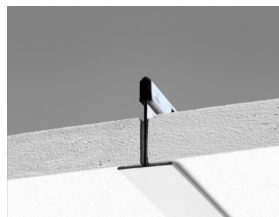

Section of Focus A system with Connect T24



Focus A system

## TYPE OF APPLICATION

- Healthcare
- Education
- Office
- Additional areas



## ACOUSTIC

### Sound Absorption

Test results according to EN ISO 354. Classification according to EN ISO 11654, and the single value ratings for Noise Reduction Coefficient, NRC and Sound Absorption Average, SAA according to ASTM C 423.

$\alpha_p$ , Practical sound absorption coefficient

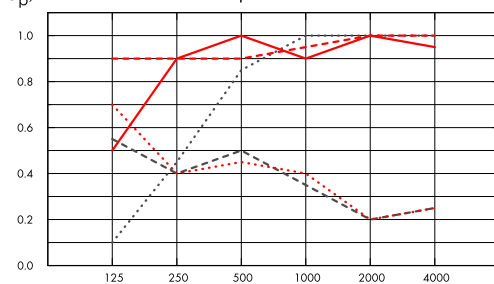

- ..... Focus A 20 mm, 50 mm o.d.s.
  - Focus A 20 mm, 200 mm o.d.s.
  - - - Focus A 20 mm + Extra Bass 50 mm, 200 mm o.d.s.
  - - - Focus A gamma 20 mm, 200 mm o.d.s.
  - ..... Focus A gamma 20 mm + Extra Bass 50 mm, 200 mm o.d.s.
- o.d.s = overall depth of system

	THK mm	o.d.s. mm	$\alpha_p$ , Practical sound absorption coefficient						$\alpha_w$	Sound absorption class
			125 Hz	250 Hz	500 Hz	1000 Hz	2000 Hz	4000 Hz		
-	20	50	0.10	0.45	0.85	1.00	1.00	1.00	0.75	C
-	20	200	0.50	0.90	1.00	0.90	1.00	0.95	1.00	A
+ Extra Bass,	70	200	0.90	0.90	0.90	0.95	1.00	1.00	0.95	A
gamma	20	200	0.55	0.40	0.50	0.35	0.20	0.25	0.30	D
gamma + Extra Bass	70	200	0.70	0.40	0.45	0.40	0.20	0.25	0.30	D

	THK mm	o.d.s. mm	NRC	SAA
-	20	50	0.85	0.83
-	20	200	0.95	0.93
+ Extra Bass,	70	200	0.95	0.93
gamma	20	200	0.35	0.36
gamma + Extra Bass	70	200	0.35	0.37
-	20	400	0.85	0.88

THK mm	AC(1.5) Articulation Class, ASTM E1111, ASTM E1110	D <sub>nfw</sub> Weighted normalized flanking level difference, ISO 10848-2	CAC dB Ceiling Attenuation Class, ASTM 1414, ASTM E413
20	190	19	21



## INDOOR AIR QUALITY

Certificate / Label	Akutex FT White Frost	
Eurofins Indoor Air Comfort*	IAC Gold	IAC
French VOC	A+	A+



## CRADLE TO CRADLE CERTIFIED®

This product is Cradle to Cradle Certified® at Bronze level (version 4.0).



## MATERIAL HEALTH

This product has received a C2C Certified Material Health Certificate™ at the Silver level (standard version 4.0). The C2C Certified Material Health Certificate™ is a verification of the health and safety of a product's composition using the Material Health requirements of the Cradle-to-Cradle Certified Product Standard.



## CARBON FOOTPRINT

Life-cycle stages A1 to C4 from EPD, in conformity with ISO 14025 / EN 15804

	kg CO <sub>2</sub> equiv/m <sup>2</sup>
Focus A	2,60
Focus A, CarbonLow (EN 15804+A2)	1,50



## CIRCULARITY

Minimum post-consumer recycled content	51%
Recyclability	Fully recyclable



## FIRE SAFETY

The glass wool core of the tiles is tested and classified as non-combustible according to EN ISO 1182.

Country	Fire standard	Class
Europe	EN 13501-1	A2-s1,d0



## HUMIDITY RESISTANCE

Class C, relative humidity 95% and 30°C, according to EN 13964:2014



## VISUAL APPEARANCE

White Frost, nearest NCS colour sample S 0500-N, 85% light reflectance. Gloss < 1.



## CLEANABILITY

Daily dusting and vacuum cleaning. Weekly wet wiping.



## ACCESSIBILITY

The tiles are easily demountable. Minimum demounting depth according to installation diagrams.



## INSTALLATION

Installed according to installation diagrams, installation guides and drawing aid. For information regarding minimum overall depth of system see quantity specification.



## PACKAGING INFORMATION

Information is indicative and subject to change.

	Edge	Panels / crt	m <sup>2</sup> / crt
600x600x20	A	28	10.08
1200x600x20	A	14	10.08
1200x1200x20	A	8	11.52
1600x600x20	A	12	11.52
1800x600x20	A	12	12.96
2000x600x20	A	12	14.40
2400x600x20	A	12	17.28



## SYSTEM WEIGHT

Weight information is indicative and subject to variation.

	kg/m <sup>2</sup>
Focus A	1,4
Focus A + Connect grid system	2,4
Focus A/Gamma	1,8
Focus A/Gamma + Connect grid system	2,8



## MECHANICAL PROPERTIES

See table about Max live load and Min load bearing capacity and Functional demands, Mechanical properties at [www.ecophon.com](http://www.ecophon.com).



## CE

Ecophon ceiling systems are CE marked according to the European harmonized standard EN13964:2014. CE marked construction products are covered by a Declaration of Performance (DOP) which enables customers and users to easily compare performance of products available on the European market.

## COLOURS AND DESIGN

### Akutex™ FT



White Frost



Deep Sea



Sage Mist

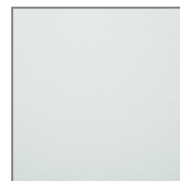

Morning Rain



Scallop Shells

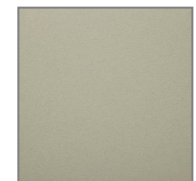

Spring Leaf



Pine Green

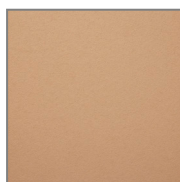

Wet Sand



Silent Steam

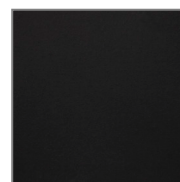

Dark Diamond



Cloudy Day

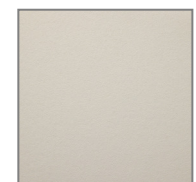

Volcanic Ash



Silver Stone

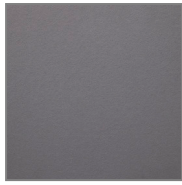

Silk Slate

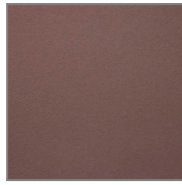

Dark Chestnut

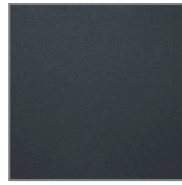

Basalt Rock

T15/T24, Suspended ceiling

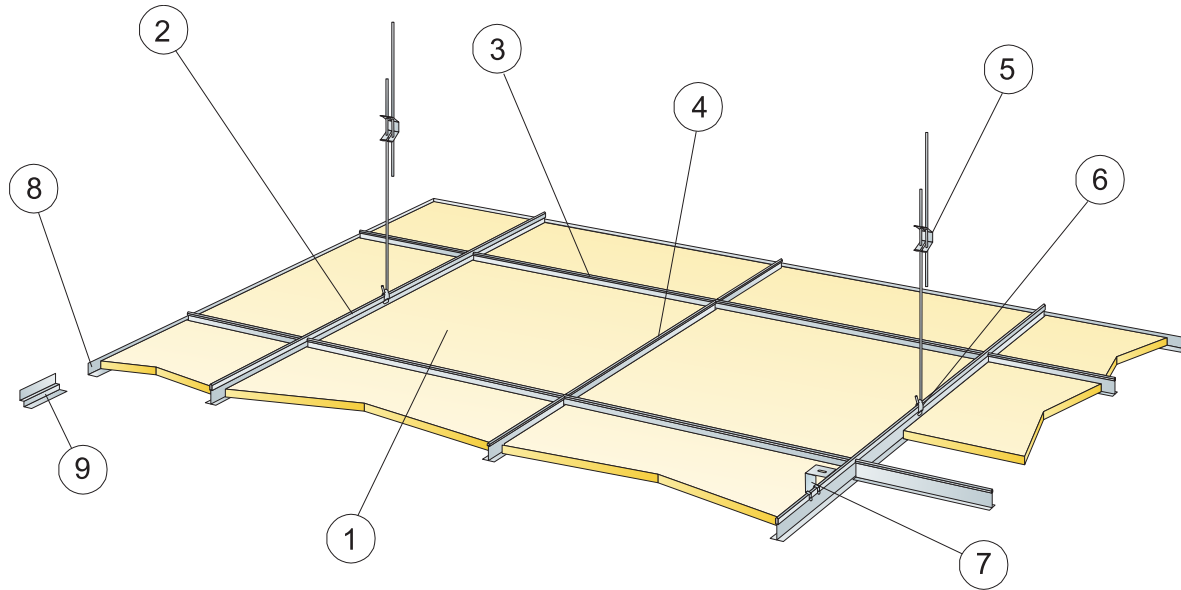

© Ecophon Group

Installation diagram (M01) for Ecophon Focus A

Quantity specification (excl. wastage)

	Size, mm		
	600x600	1200x600	1200x1200
1 Focus A	2,8/m <sup>2</sup>	1,4/m <sup>2</sup>	0,7/m <sup>2</sup>
2 Connect T24 or T15 Main runner, installed at 1200 mm centres (max. distance from wall 600 mm, can be extended up to 1200 mm if no live load between Main runner and wall).	0,9m/m <sup>2</sup>	0,9m/m <sup>2</sup>	0,9m/m <sup>2</sup>
3 Connect T24 or T15 Cross tee, L=1200 mm, installed at 600 mm centres	1,7m/m <sup>2</sup>	1,7m/m <sup>2</sup>	0,9m/m <sup>2</sup>
4 Connect T24 or T15 Cross tee, L=600 mm	0,9m/m <sup>2</sup>	-	-
5 Connect Adjustable hanger, installed at 1200 mm centres (max. distance from wall 600 mm)	0,7/m <sup>2</sup>	0,7/m <sup>2</sup>	0,7/m <sup>2</sup>
6 Connect Hanger Clip (not to be used in swimming hall environments)	0,7/m <sup>2</sup>	0,7/m <sup>2</sup>	0,7/m <sup>2</sup>
7 For direct installation: Connect Direct Bracket, installed at 1200 mm centres	0,7/m <sup>2</sup>	0,7/m <sup>2</sup>	0,7/m <sup>2</sup>
8 Connect Angle trim, fixed at 300 mm centres	as required	as required	as required
9 Connect Shadow-line trim, fixed at 300 mm centres	as required	as required	as required
Δ Min. overall depth of system, with adjustable hanger: 100 mm, with direct bracket: 50 mm			
δ Min. demounting depth: 120 mm (130 mm with 1200x1200)			
For luminaire integration in panels use Connect Bridging	as required as required		
When using panels in format 1200x1200 mm and XL-format in combination with T15 grid, secure grid with wall brackets			

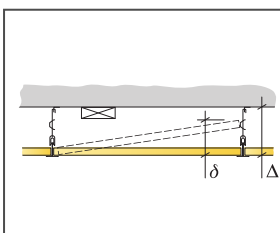

See Quantity Specification

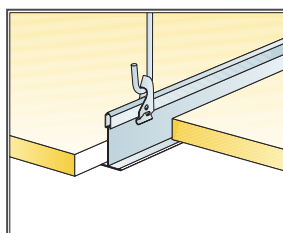

Suspension with adjustable hanger and clip

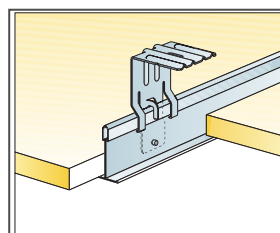

Suspension with direct bracket

Size, mm	Max live load (N)	Min load bearing capacity (N)
600x600x20	50	160
1200x600x20	50	160
1200x1200x20	50	160

Live load/load bearing capacity

Corridor installation

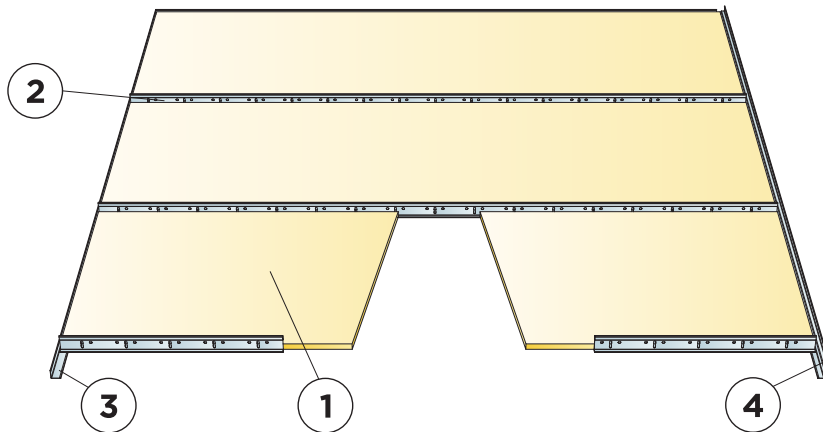

© Saint-Gobain Ecophon AB

Installation diagram (M16) for Ecophon Focus A XL in corridors

Quantity specification (excl. wastage)

	Size, mm			
	1600x600	1800x600	2000x600	2400x600
1 Focus A XL	1,05/m <sup>2</sup>	0,95/m <sup>2</sup>	0,85/m <sup>2</sup>	0,7/m <sup>2</sup>
2 Connect T24 Corridor profile, installed at 600 mm centres	1,05/m <sup>2</sup>	0,95/m <sup>2</sup>	0,85/m <sup>2</sup>	0,7/m <sup>2</sup>
3 Connect Angle trim, fixed at 200 mm centres	as required	as required	as required	as required
4 Connect Shadow-line trim, fixed at 200 mm centres	as required	as required	as required	as required
Δ Min. overall depth of system: 40 mm				
δ Min. demounting depth: 65 mm				

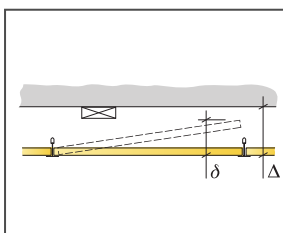

Size, mm	Max live load (N)	Min load bearing capacity (N)
1600x600x20	40	-
1800x600x20	20	-
2000x600x20	10	-
2400x600x20	0	-

Live load/load bearing capacity

XL in grid

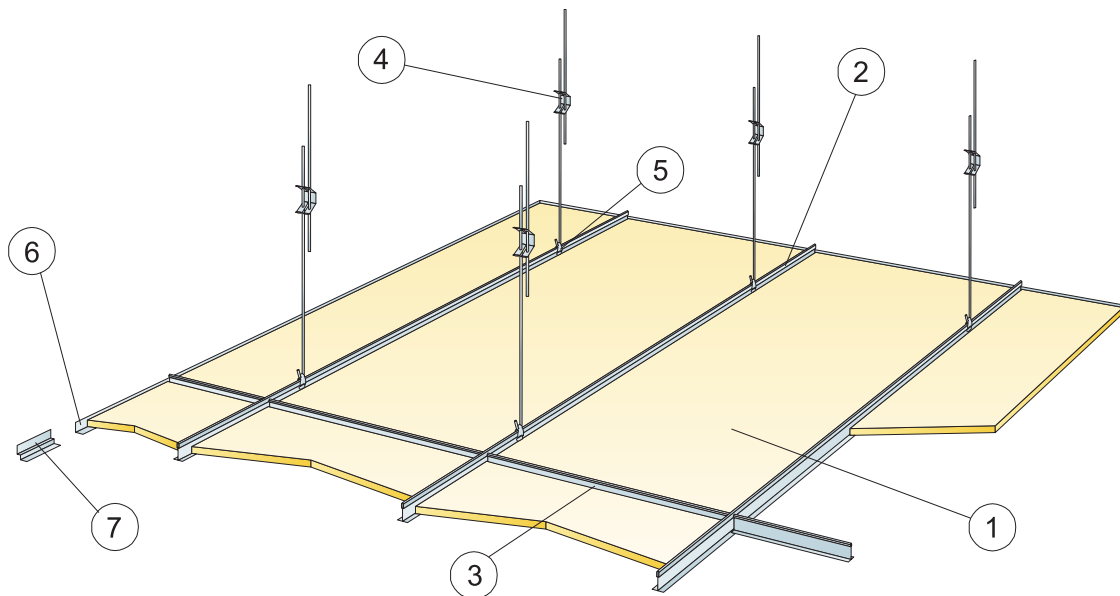

© Ecophon Group

Installation diagram (M46) for Ecophon Focus A XL

Quantity specification (excl. wastage)

	Size, mm			
	1600x600	1800x600	2000x600	2400x600
1 Focus A XL	1,05/m <sup>2</sup>	0,95/m <sup>2</sup>	0,85/m <sup>2</sup>	0,7/m <sup>2</sup>
2 Connect T24 Main runner, installed at 600 mm centres	1,7m/m <sup>2</sup>	1,7m/m <sup>2</sup>	1,7m/m <sup>2</sup>	1,7m/m <sup>2</sup>
3 Connect T24 Cross tee, L=600 mm	0,65m/m <sup>2</sup>	0,6m/m <sup>2</sup>	0,5m/m <sup>2</sup>	0,45m/m <sup>2</sup>
4 Connect Adjustable hanger, installed at 1500 mm centres (max. distance from wall 450 mm)	1,1/m <sup>2</sup>	1,1/m <sup>2</sup>	1,1/m <sup>2</sup>	1,1/m <sup>2</sup>
5 Connect Hanger clip	1,1/m <sup>2</sup>	1,1/m <sup>2</sup>	1,1/m <sup>2</sup>	1,1/m <sup>2</sup>
6 Connect Angle trim, fixed at 300 mm centres	as required	as required	as required	as required
7 Connect Shadow-line trim, fixed at 300 mm centres	as required	as required	as required	as required
Δ Min. overall depth of system: 100 mm				
δ Min. demounting depth: 100 mm				

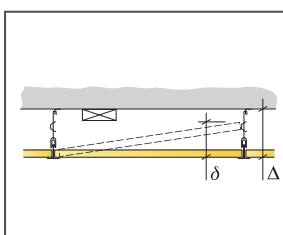

See Quantity Specification

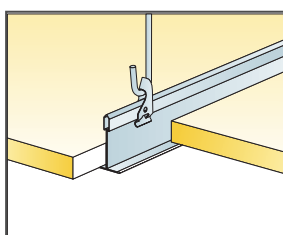

Suspension with adjustable hanger and clip

Size, mm	Max live load (N)	Min load bearing capacity (N)
1600x600x20	50	160
1800x600x20	50	160
2000x600x20	50	160
2400x600x20	50	160

Live load/load bearing capacity

Suspended ceiling with Extra Bass

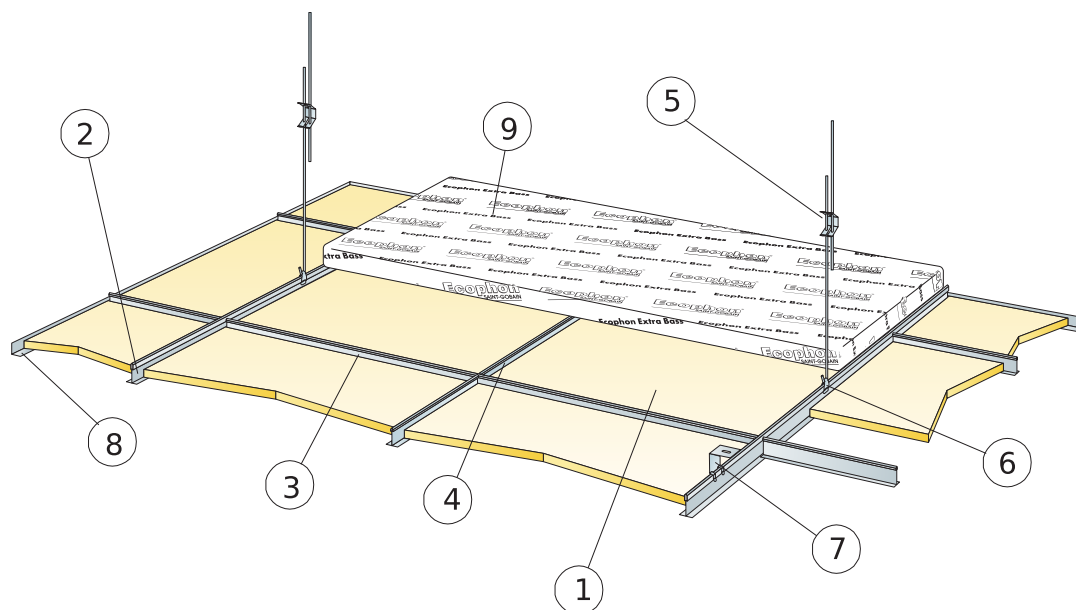

© Ecophon Group

Installation diagram (M399) for Ecophon Focus A

Quantity specification (excl. wastage)

	Size, mm	
	600x600	1200x600
1 Focus A	2,8/m <sup>2</sup>	1,4/m <sup>2</sup>
2 Connect T24 Main runner, installed at 1200 mm centres (max. distance from wall 600 mm, can be extended up to 1200 mm if no live load between Main runner and wall).	0,9m/m <sup>2</sup>	0,9m/m <sup>2</sup>
3 Connect T24 Main runner, installed at 1200 mm centres (max. distance from wall 600 mm, can be extended up to 1200 mm if no live load between Main runner and wall).	0,9m/m <sup>2</sup>	0,9m/m <sup>2</sup>
4 Connect T24 Cross tee, L=600 mm	0,9m/m <sup>2</sup>	-
5 Connect Adjustable Hanger, installed at 1200 mm centres (max. distance from wall 600 mm)	0,7/m <sup>2</sup>	0,7/m <sup>2</sup>
6 Connect Hanger Clip (not to be used in swimming hall environments)	0,7/m <sup>2</sup>	0,7/m <sup>2</sup>
7 For direct installation: Connect Direct Bracket, installed at 1200 mm centres	0,7/m <sup>2</sup>	0,7/m <sup>2</sup>
8 Connect Angle trim, fixed at 300 mm centres	as required	as required
9 Extra Bass (1200x600x50 mm)	0,7/m <sup>2</sup>	0,7/m <sup>2</sup>
Δ Min. overall depth of system: Focus A: 50 mm (Direct bracket). Focus A/with Extra bass: 100 mm.		
δ Min. demounting depth: Focus A: 130 mm, Focus A/with Extra bass: 170 mm		

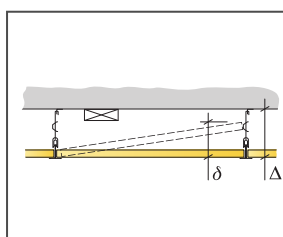

See Quantity Specification

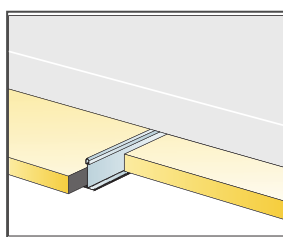

Installation with Extra Bass

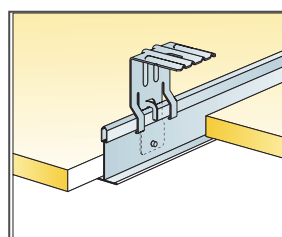

Fixing with direct bracket

Size, mm	Max live load (N)	Min load bearing capacity (N)
600x600x20	50	160
1200x600x20	50	160

Live load/load bearing capacity