

# ECOPHON FOCUS™ DG

Ecophon Focus™ Dg conceals the supporting tile edges and creates a distinctive floating appearance. Tiles are easily demountable even in areas where there is a very small overall depth of system. For applications where a unique demountable suspended ceiling is required.



# Ecophon Focus™ Dg

## SYSTEM RANGE



Size, mm	600x600	1200x600	1200x1200	XL 1600x600	XL 1800x600	XL 2000x600	XL 2400x600
T24	•	•	•	•	•	•	•
Thickness	20	20	25	20	20	20	20
Inst. Diagr.	M202	M202	M203	M204	M204	M204	M204

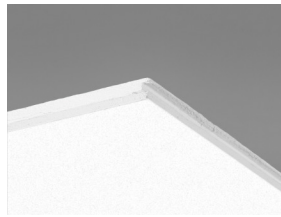

Focus Dg tile

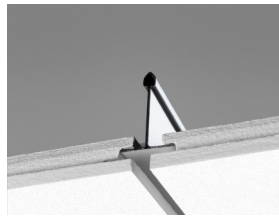

Section of Focus Dg system with Connect T24 Main runner HD

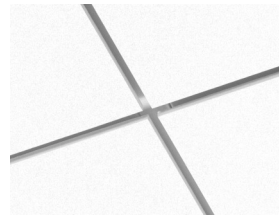

Section of Focus Dg system

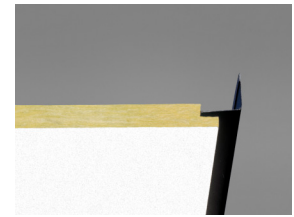

Focus Dg with Connect Angle trim Ultra matt black

## TYPE OF APPLICATION

- Healthcare
- Education
- Office
- Additional areas



## ACOUSTIC

### Sound Absorption

Test results according to EN ISO 354. Classification according to EN ISO 11654, and the single value ratings for Noise Reduction Coefficient, NRC and Sound Absorption Average, SAA according to ASTM C 423.

$\alpha_p$ , Practical sound absorption coefficient

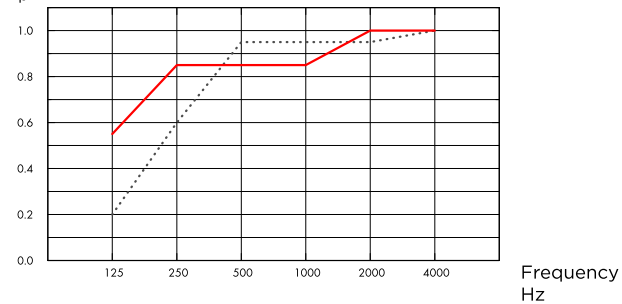

- Focus Dg 20 mm, 65 mm o.d.s.
  - Focus Dg 20 mm, 200 mm o.d.s.
- o.d.s = overall depth of system

THK mm	o.d.s. mm	$\alpha_p$ , Practical sound absorption coefficient						$\alpha_w$	Sound absorption class
		125 Hz	250 Hz	500 Hz	1000 Hz	2000 Hz	4000 Hz		
20	65	0.20	0.60	0.95	0.95	0.95	1.00	0.90	A
20	200	0.55	0.85	0.85	0.85	1.00	1.00	0.90	A

THK mm	o.d.s. mm	NRC	SAA
20	65	0.90	0.89
20	400	0.80	0.82

THK mm	AC(1.5) Articulation Class, ASTM E1111, ASTM E1110
20	180



## INDOOR AIR QUALITY

Certificate / Label	Akutex FT White Frost	
Eurofins Indoor Air Comfort®	IAC Gold	IAC
French VOC	A+	A+



## CRADLE TO CRADLE CERTIFIED®

This product is Cradle to Cradle Certified® at Bronze level (version 4.0).



## MATERIAL HEALTH

This product has received a C2C Certified Material Health Certificate™ at the Silver level (standard version 4.0). The C2C Certified Material Health Certificate™ is a verification of the health and safety of a product's composition using the Material Health requirements of the Cradle-to-Cradle Certified Product Standard.



## CARBON FOOTPRINT

Life-cycle stages A1 to C4 from EPD, in conformity with ISO 14025 / EN 15804

	kg CO <sub>2</sub> equiv/m <sup>2</sup>
Focus Dg	4,20



## CIRCULARITY

Minimum post-consumer recycled content	59%
Recyclability	Fully recyclable



## FIRE SAFETY

The glass wool core of the tiles is tested and classified as non-combustible according to EN ISO 1182.

Country	Fire standard	Class
Europe	EN 13501-1	A2-s1,d0



## HUMIDITY RESISTANCE

Class C, relative humidity 95% and 30°C, according to EN 13964:2014



## VISUAL APPEARANCE

White Frost, nearest NCS colour sample S 0500-N, 85% light reflectance. Gloss < 1.



## CLEANABILITY

Daily dusting and vacuum cleaning. Weekly wet wiping.



## ACCESSIBILITY

The tiles in size 600x600 and 1200x600 are easily demountable. The tiles in size 1200x1200 and XL sizes are demountable. Minimum demounting depth according to installation diagrams.



## INSTALLATION

Installed according to installation diagrams, installation guides and drawing aid. For information regarding minimum overall depth of system see quantity specification. The systems are not recommended for small rooms (approximately 2x2 m<sup>2</sup>). Ceilings with a large amount of integrations require careful planning, design and installation.



## PACKAGING INFORMATION

Information is indicative and subject to change.

	Edge	Panels / crt	m <sup>2</sup> / crt
600x600x20	Dg	20	7.20
1200x600x20	Dg	10	7.20
1200x1200x25	Dg	6	8.64
1600x600x20	Dg	6	5.76
1800x600x20	Dg	6	6.48
2000x600x20	Dg	6	7.20
2400x600x20	Dg	6	8.64



## SYSTEM WEIGHT

Weight information is indicative and subject to variation.

	kg/m <sup>2</sup>
Focus Dg	2,3
Focus Dg + Connect grid system	3,3
Focus Dg 25 mm	2,8
Focus Dg 25 mm + Connect grid system	3,8



## MECHANICAL PROPERTIES

See table about Max live load and Min load bearing capacity and Functional demands, Mechanical properties at [www.ecophon.com](http://www.ecophon.com).



## CE

Ecophon ceiling systems are CE marked according to the European harmonized standard EN13964:2014. CE marked construction products are covered by a Declaration of Performance (DOP) which enables customers and users to easily compare performance of products available on the European market.

## COLOURS AND DESIGN

### Akutex™ FT



White Frost



Deep Sea

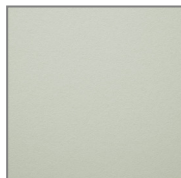

Sage Mist

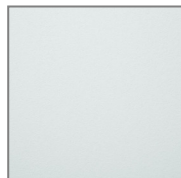

Morning Rain



Scallop Shells

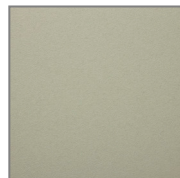

Spring Leaf



Pine Green

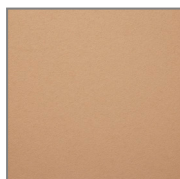

Wet Sand



Silent Steam



Dark Diamond



Cloudy Day



Volcanic Ash



Silver Stone

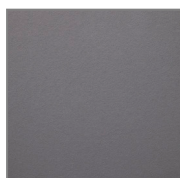

Silk Slate

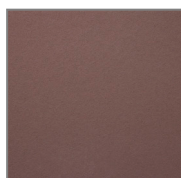

Dark Chestnut



Basalt Rock

Suspended ceiling

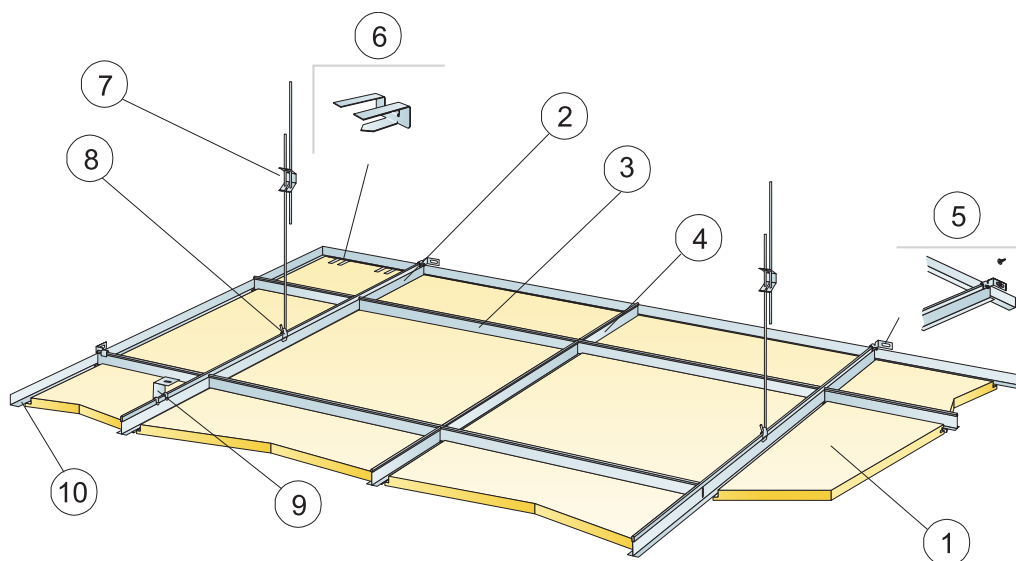

© Ecophon Group

Installation diagram (M202) for Ecophon Focus Dg 600x600, 1200x600 mm

Quantity specification (excl. wastage)

	Size, mm	
	600x600	1200x600
1 Focus Dg	2,8/m <sup>2</sup>	1,4/m <sup>2</sup>
2 Connect T24 Main runner HD, installed at 1200 mm centres (max. distance from wall 600 mm, can be extended up to 1200 mm if no live load between Main runner and wall).	0,9m/m <sup>2</sup>	0,9m/m <sup>2</sup>
3 Connect T24 Cross tee, L=1200 mm, installed at 600 mm centres	1,7m/m <sup>2</sup>	1,7m/m <sup>2</sup>
4 Connect T24 Cross tee, L=600 mm	0,9m/m <sup>2</sup>	-
5 Connect Wall Bracket for T-profiles	1/suspended row of Main runner	
6 Connect Support clip DG20	1/300-400mm on any cut edge	
7 Connect Adjustable Hanger, installed at 1200 mm centres (max. distance from wall 600 mm)	0,7/m <sup>2</sup>	0,7/m <sup>2</sup>
8 Connect Hanger Clip (not to be used in swimming hall environments)	0,7/m <sup>2</sup>	0,7/m <sup>2</sup>
9 For direct installation: Connect Direct Bracket, installed at 1200 mm centres	0,7/m <sup>2</sup>	0,7/m <sup>2</sup>
10 Connect Angle trim, fixed at 300 mm centres	as required	as required
Min. overall depth of system, with Adjustable hanger: 115 mm, with Direct bracket: 65 mm		
δ Min. demounting depth: 30 mm		
For luminaire integration in panels use Connect Bridging	as required	as required

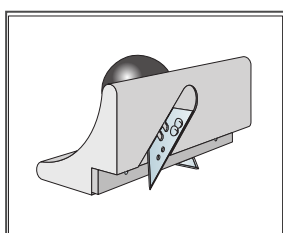
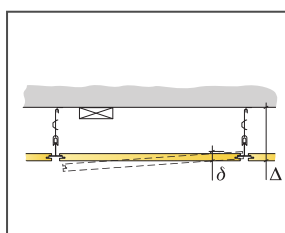

Cutting tool Dg

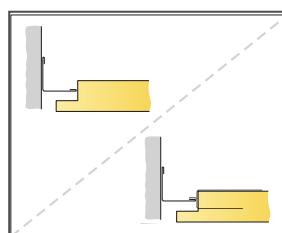

Cut edge with and without support clip

Size, mm	Max live load (N)	Min load bearing capacity (N)
600x600x20	50	160
1200x600x20	50	160

Live load/load bearing capacity

Suspended ceiling

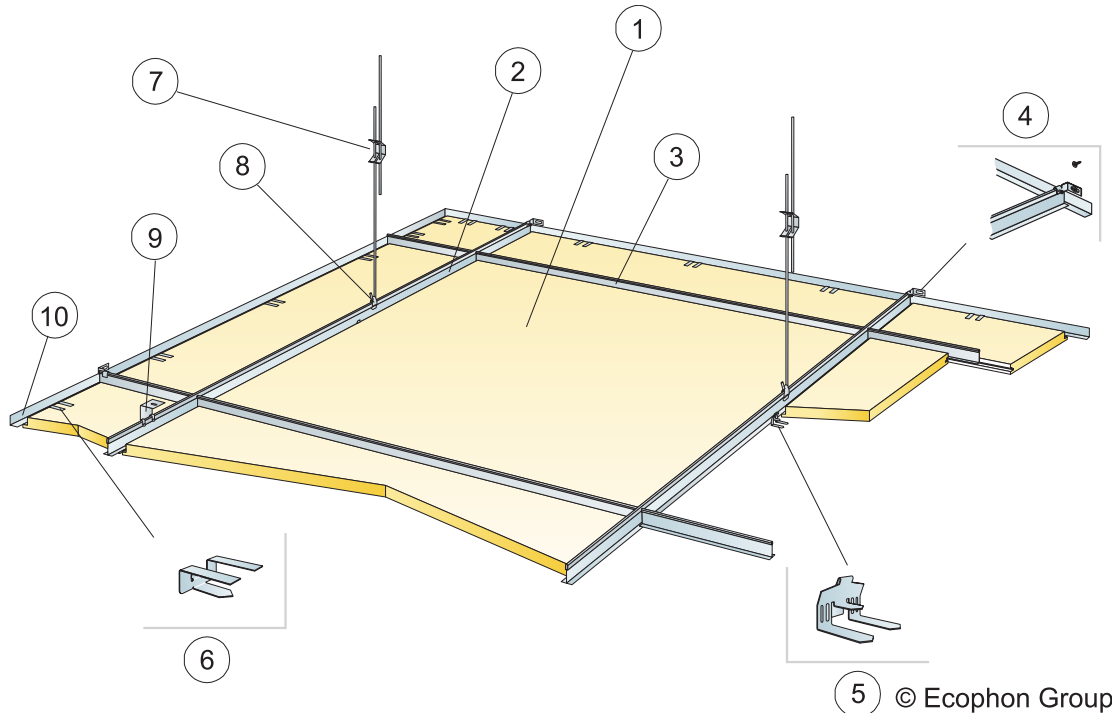

Installation diagram (M203) for Ecophon Focus Dg 1200x1200 mm

Quantity specification (excl. wastage)

	Size, mm
	1200x1200
1 Focus Dg	0,7/m <sup>2</sup>
2 Connect T24 Main runner HD, installed at 1200 mm centres (max. distance from wall 600 mm, can be extended up to 1200 mm if no live load between Main runner and wall).	0,9m/m <sup>2</sup>
3 Connect T24 Cross tee, L=1200 mm, installed at 1200 mm centres	0,9m/m <sup>2</sup>
4 Connect Wall Bracket for T-profiles	1/suspended row of Main runner
5 Connect Edge clip	1,4/m <sup>2</sup>
6 Connect Support clip DG25	1/300-400mm on any cut edge
7 Connect Adjustable Hanger, installed at 1200 mm centres (max. distance from wall 600 mm)	0,7/m <sup>2</sup>
8 Connect Hanger Clip (not to be used in swimming hall environments)	0,7/m <sup>2</sup>
9 For direct installation: Connect Direct Bracket, installed at 1200 mm centres	0,7/m <sup>2</sup>
10 Connect Angle trim, fixed at 300 mm centres	as required
Min. overall depth of system, with Adjustable hanger: 115 mm, with Direct bracket: 65 mm	
δ Min. demounting depth: 30 mm	
For luminaire integration in panels use Connect Bridging	

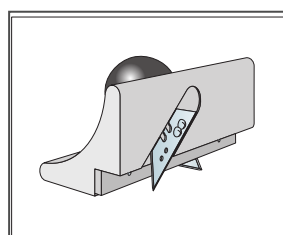
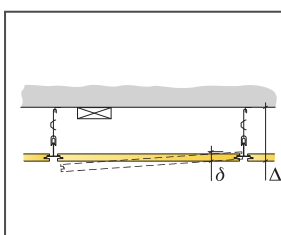

Cutting tool Dg

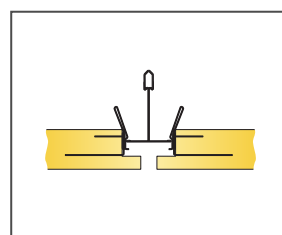

Joint between two unsupported edges with Edge clip

Size, mm	Max live load (N)	Min load bearing capacity (N)
1200x1200x25	50	160

Live load/load bearing capacity

XL in grid

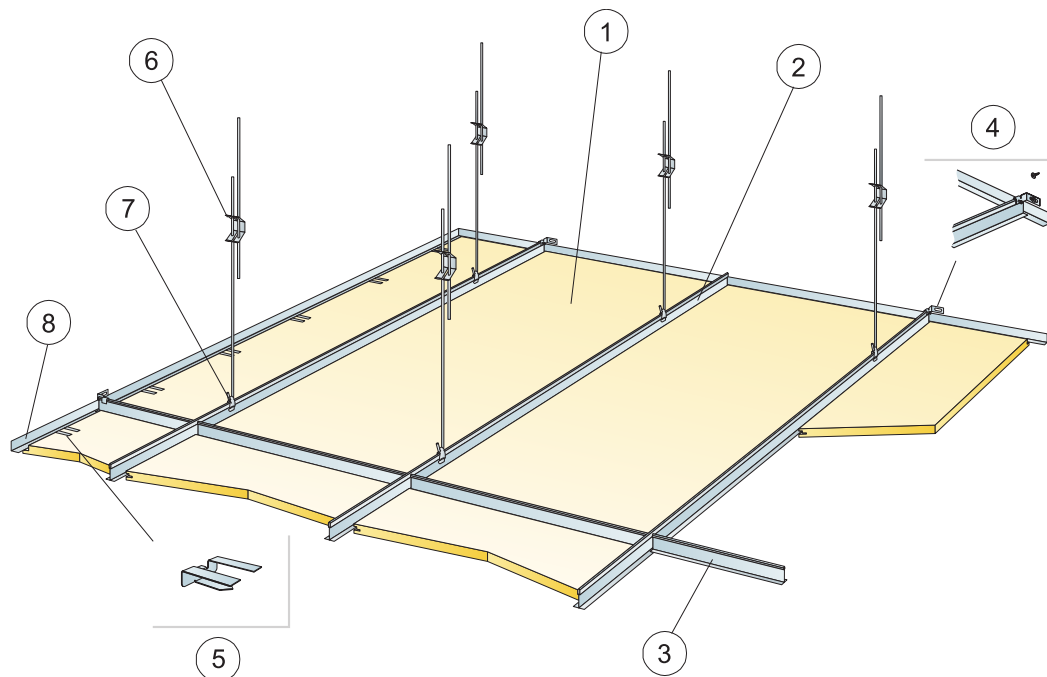

© Ecophon Group

Installation diagram (M204) for Ecophon Focus Dg XL

Quantity specification (excl. wastage)

	Size, mm			
	1600x600	1800x600	2000x600	2400x600
1 Focus Dg XL	1,05/m <sup>2</sup>	0,95/m <sup>2</sup>	0,85/m <sup>2</sup>	0,7/m <sup>2</sup>
2 Connect T24 Main runner HD, installed at 600 mm centres	1,7m/m <sup>2</sup>	1,7m/m <sup>2</sup>	1,7m/m <sup>2</sup>	1,7m/m <sup>2</sup>
3 Connect T24 Cross tee, L=600 mm	0,65m/m <sup>2</sup>	0,6m/m <sup>2</sup>	0,5m/m <sup>2</sup>	0,45m/m <sup>2</sup>
4 Connect Wall Bracket for T-profiles	1/suspended row of Main runner			
5 Connect Support clip DG20	1pc/300-400 mm on every cut perimeter tile with only 1 supporting edge			
6 Connect Adjustable hanger, installed at 1500 mm centres (max. distance from wall 450 mm)	1,1/m <sup>2</sup>	1,1/m <sup>2</sup>	1,1/m <sup>2</sup>	1,1/m <sup>2</sup>
7 Connect Hanger clip	1,1/m <sup>2</sup>	1,1/m <sup>2</sup>	1,1/m <sup>2</sup>	1,1/m <sup>2</sup>
8 Connect Angle trim, fixed at 300 mm centres	as required	as required	as required	as required
Δ Min. overall depth of system: 115 mm	-	-	-	-
δ Min. demounting depth: 30 mm	-	-	-	-

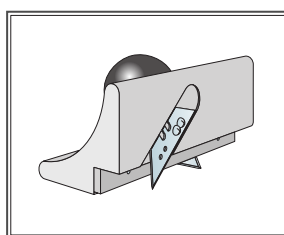
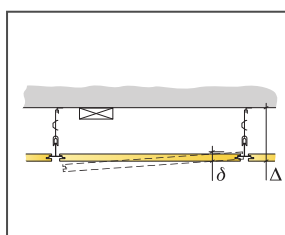

Cutting tool Dg

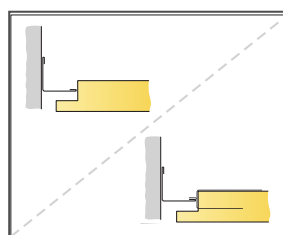

Cut edge with and without support clip

Size, mm	Max live load (N)	Min load bearing capacity (N)
1600x600x20	50	160
1800x600x20	50	160
2000x600x20	50	160
2400x600x20	50	160

Live load/load bearing capacity