

ECOPHON FOCUS™ EZ

Ecophon Focus™ Ez has a recessed visible grid with diagonal edge design, creating a new design feature to the ceiling. For applications with high demands on good acoustics and speech intelligibility.



Ecophon Focus™ Ez

SYSTEM RANGE



Size, mm	600x600
T24	•
Thickness	40
Inst. Diagr.	M393

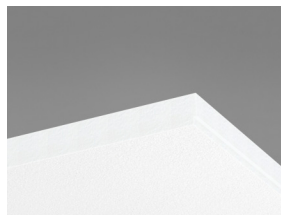

Focus Ez tile

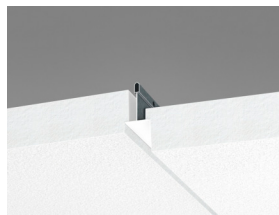

Section of Focus Ez system with Connect T24

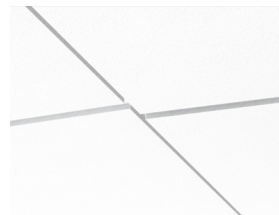

Focus Ez system with Connect T24



TYPE OF APPLICATION

- Healthcare
- Education
- Office



ACOUSTIC

Sound Absorption

Test results according to EN ISO 354. Classification according to EN ISO 11654, and the single value ratings for Noise Reduction Coefficient, NRC and Sound Absorption Average, SAA according to ASTM C 423.

α_p , Practical sound absorption coefficient

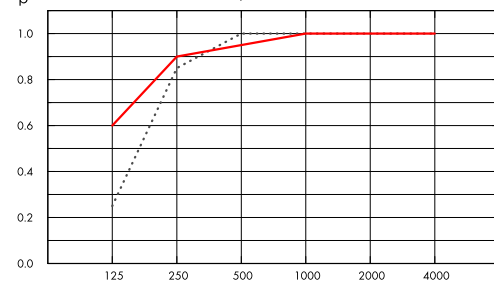

..... Focus Ez 40 mm, 60 mm o.d.s.

— Focus Ez 40 mm, 200 mm o.d.s.

o.d.s = overall depth of system

THK mm	o.d.s. mm	α_p , Practical sound absorption coefficient						α_w	Sound absorption class
		125 Hz	250 Hz	500 Hz	1000 Hz	2000 Hz	4000 Hz		
40	60	0.25	0.85	1.00	1.00	1.00	1.00	1.00	A
40	200	0.60	0.90	0.95	1.00	1.00	1.00	1.00	A

THK mm	o.d.s. mm	NRC	SAA
40	60	1.00	0.99
40	200	1.00	0.97

THK mm	AC(1.5) Articulation Class, ASTM E1111, ASTM E1110	D_{nfw} Weighted normalized flanking level difference, ISO 10848-2	CAC dB Ceiling Attenuation Class, ASTM 1414, ASTM E413
40	200	29	31



INDOOR AIR QUALITY

Certificate / Label	Akutex FT White Frost	
Eurofins Indoor Air Comfort®	IAC Gold	IAC
French VOC	A+	A+



CRADLE TO CRADLE CERTIFIED®

This product is Cradle to Cradle Certified® at Bronze level (version 4.0).



MATERIAL HEALTH

This product has received a C2C Certified Material Health Certificate™ at the Silver level (standard version 4.0). The C2C Certified Material Health Certificate™ is a verification of the health and safety of a product's composition using the Material Health requirements of the Cradle-to-Cradle Certified Product Standard.



CARBON FOOTPRINT

Life-cycle stages A1 to C4 from EPD, in conformity with ISO 14025 / EN 15804

	kg CO ₂ equiv/m ²
Focus Ez	5,9



CIRCULARITY

Minimum post-consumer recycled content	62%
Recyclability	Fully recyclable



FIRE SAFETY

The glass wool core of the tiles is tested and classified as non-combustible according to EN ISO 1182.

Country	Fire standard	Class
Europe	EN 13501-1	A2-s1,d0



HUMIDITY RESISTANCE

Class C, relative humidity 95% and 30°C, according to EN 13964:2014



VISUAL APPEARANCE

White Frost, nearest NCS colour sample S 0500-N, 85% light reflectance. Gloss < 1.



CLEANABILITY

Daily dusting and vacuum cleaning. Weekly wet wiping.



ACCESSIBILITY

The tiles are easily demountable. Minimum demounting depth according to installation diagrams.



INSTALLATION

Installed according to installation diagrams, installation guides and drawing aid. For information regarding minimum overall depth of system see quantity specification.



PACKAGING INFORMATION

Information is indicative and subject to change.

	Edge	Panels / crt	m ² / crt
600x600x40	Ez	10	3.60



SYSTEM WEIGHT

Weight information is indicative and subject to variation.

	kg/m ²
Focus Ez	3,5
Focus Ez + Connect grid system	4,5



MECHANICAL PROPERTIES

See table about Max live load and Min load bearing capacity and Functional demands, Mechanical properties at www.ecophon.com.



CE

Ecophon ceiling systems are CE marked according to the European harmonized standard EN13964:2014. CE marked construction products are covered by a Declaration of Performance (DOP) which enables customers and users to easily compare performance of products available on the European market.

COLOURS AND DESIGN

Akutex™ FT



White Frost



Deep Sea



Sage Mist

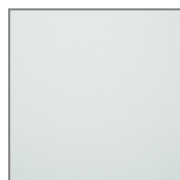

Morning Rain



Scallop Shells

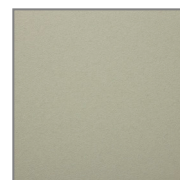

Spring Leaf



Pine Green

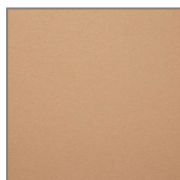

Wet Sand



Silent Steam



Dark Diamond



Cloudy Day

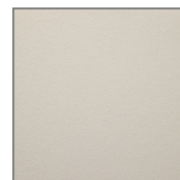

Volcanic Ash

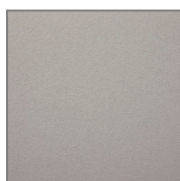

Silver Stone

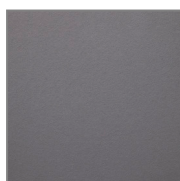

Silk Slate

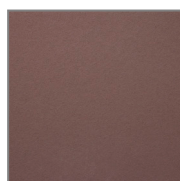

Dark Chestnut



Basalt Rock

Suspended ceiling

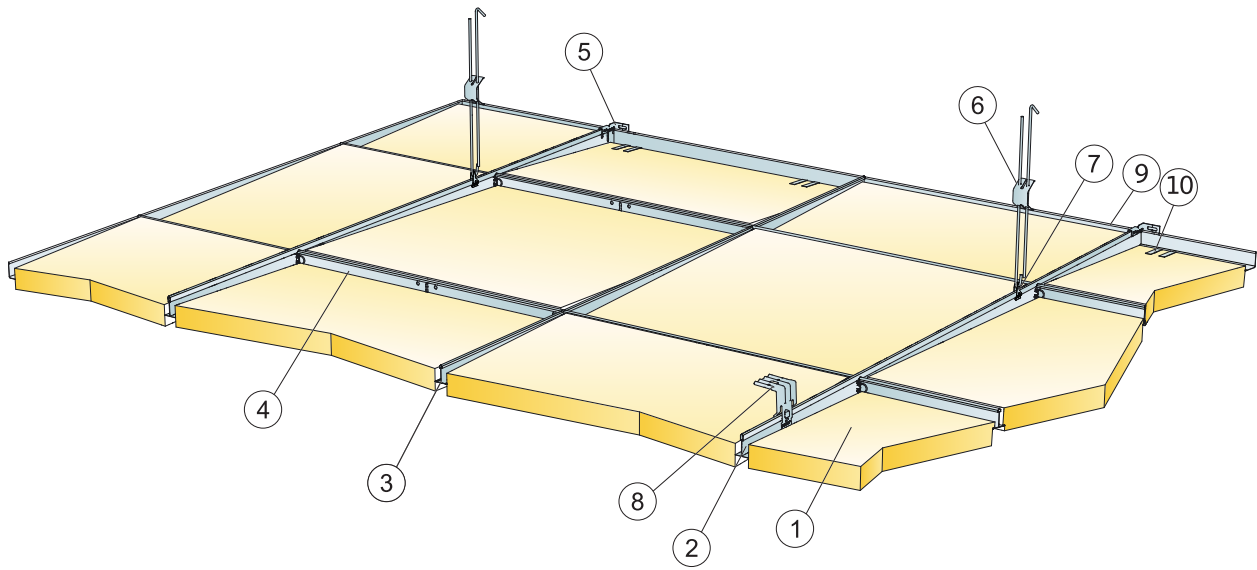

Installation diagram (M393) for Ecophon Focus Ez

Quantity specification (excl. wastage)

	Size, mm
	600x600
1 Focus Ez	2,8/m ²
2 Connect T24 Main runner, installed at 1200 mm centres (max. distance from wall 600 mm, can be extended up to 1200 mm if no live load between Main runner and wall).	0,9m/m ²
3 Connect T24 Cross tee, L=1200 mm, installed at 600 mm centres	1,7m/m ²
4 Connect T24 Cross tee, L=600 mm	0,9m/m ²
5 Connect Wall Bracket for T-profiles	1/suspended row of Main runner
6 Connect Adjustable Hanger, installed at 1200 mm centres (max. distance from wall 600 mm)	0,7/m ²
7 Connect Hanger Clip (not to be used in swimming hall environments)	0,7/m ²
8 For direct installation: Connect Direct Bracket, installed at 1200 mm centres	0,7/m ²
9 Connect Angle trim, fixed at 300 mm centres	as required
10 Connect Support clip DG25	2/300-400mm on any cut edge
Δ Min. overall depth of system, with Adjustable hanger: 110 mm, with Direct bracket: 80 mm.	
δ Min. demounting depth: 80 mm	

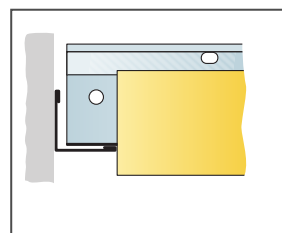
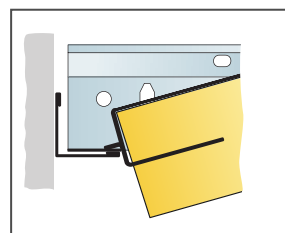
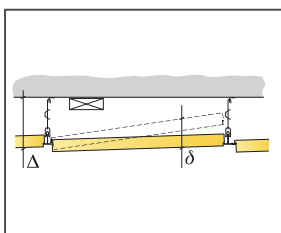

Size, mm	Max live load (N)	Min load bearing capacity (N)
600x600x40	40	160

Cut edge with Connect Support clip Dg25

Wall connection non-supported edge

Live load/load bearing capacity