

ECOPHON MASTER™ A

Ecophon Master™ A has an exposed grid system. Each tile is easily demountable. Suitable for open plan offices or other premises where strict demands are made on good acoustics and speech intelligibility, and where demountability is vital.



Ecophon Master™ A

SYSTEM RANGE



Size, mm	600x600	1200x600	1200x1200
Connect T15	•	•	•
Connect T24	•	•	•
Thickness	40	40	40
Inst. Diagr.	M56	M56	M56

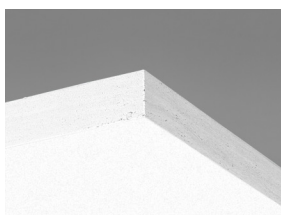

Master A tile

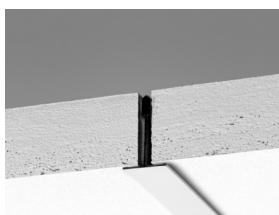

Section of Master A system

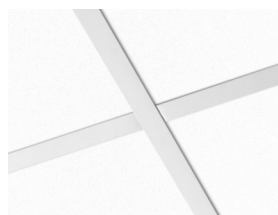

Master A system

TYPE OF APPLICATION

- Healthcare
- Education
- Office



ACOUSTIC

Sound Absorption

Test results according to EN ISO 354. Classification according to EN ISO 11654, and the single value ratings for Noise Reduction Coefficient, NRC and Sound Absorption Average, SAA according to ASTM C 423.

α_p , Practical sound absorption coefficient

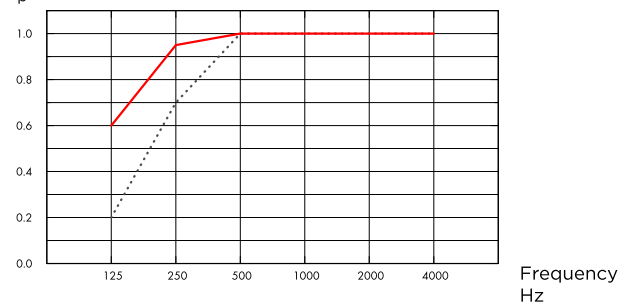

- Master A 40 mm, 50 mm o.d.s.
 - Master A 40 mm, 200 mm o.d.s.
- o.d.s = overall depth of system

THK mm	o.d.s. mm	α_p , Practical sound absorption coefficient						α_w	Sound absorption class
		125 Hz	250 Hz	500 Hz	1000 Hz	2000 Hz	4000 Hz		
40	50	0.20	0.70	1.00	1.00	1.00	1.00	1.00	A
40	200	0.60	0.95	1.00	1.00	1.00	1.00	1.00	A

THK mm	o.d.s. mm	NRC	SAA
40	50	1.00	1.00
40	400	0.95	0.93

THK mm	AC(1.5) Articulation Class, ASTM E1111, ASTM E1110	D_{nfw} Weighted normalized flanking level difference, ISO 10848-2	CAC dB Ceiling Attenuation Class, ASTM 1414, ASTM E413
40	200	28	30



INDOOR AIR QUALITY

Certificate / Label	Akutex FT White Frost	
Eurofins Indoor Air Comfort®	IAC Gold	IAC
French VOC	A+	A+



CRADLE TO CRADLE CERTIFIED®

This product is Cradle to Cradle Certified® at Bronze level (version 4.0).



MATERIAL HEALTH

This product has received a C2C Certified Material Health Certificate™ at the Silver level (standard version 4.0). The C2C Certified Material Health Certificate™ is a verification of the health and safety of a product's composition using the Material Health requirements of the Cradle-to-Cradle Certified Product Standard.



CARBON FOOTPRINT

Life-cycle stages A1 to C4 from EPD, in conformity with ISO 14025 / EN 15804

	kg CO ₂ equiv/m ²
Master A	3,70
Master A, CarbonLow (EN 15804+A2)	2,40



CIRCULARITY

Minimum post-consumer recycled content	59%
Recyclability	Fully recyclable



FIRE SAFETY

The glass wool core of the tiles is tested and classified as non-combustible according to EN ISO 1182.

Country		Class
Europe	EN 13501-1	A2-s1,d0



HUMIDITY RESISTANCE

Class C, relative humidity 95% and 30°C, according to EN 13964:2014



PACKAGING INFORMATION

Information is indicative and subject to change.

	Edge	Panels / crt	m ² / crt
600x600x40	A	20	7.20
1200x600x40	A	10	7.20
1200x1200x40	A	6	8.64
625x625x40	A	20	7.81



SYSTEM WEIGHT

Weight information is indicative and subject to variation.

	kg/m ²
Master A	2,5
Master A + Connect grid system	3,5



VISUAL APPEARANCE

White Frost, nearest NCS colour sample S 0500-N, 85% light reflectance. Gloss < 1.



CLEANABILITY

Daily dusting and vacuum cleaning. Weekly wet wiping.



ACCESSIBILITY

The tiles are easily demountable. Minimum demounting depth according to installation diagrams.



INSTALLATION

Installed according to installation diagrams, installation guides and drawing aid. For information regarding minimum overall depth of system see quantity specification.



CE

Ecophon ceiling systems are CE marked according to the European harmonized standard EN13964:2014. CE marked construction products are covered by a Declaration of Performance (DOP) which enables customers and users to easily compare performance of products available on the European market.



MECHANICAL PROPERTIES

See table about Max live load and Min load bearing capacity and Functional demands, Mechanical properties at www.ecophon.com.

COLOURS AND DESIGN

Akutex™ FT

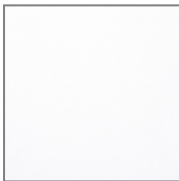

White Frost

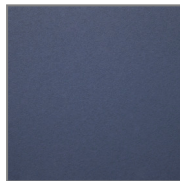

Deep Sea



Sage Mist

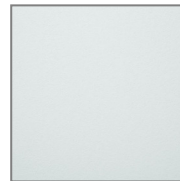

Morning Rain



Scallop Shells

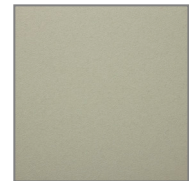

Spring Leaf



Pine Green

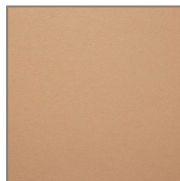

Wet Sand



Silent Steam



Dark Diamond



Cloudy Day

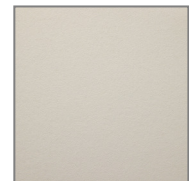

Volcanic Ash

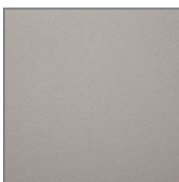

Silver Stone



Silk Slate

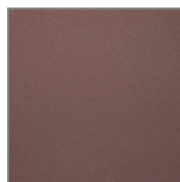

Dark Chestnut



Basalt Rock

Suspended ceiling

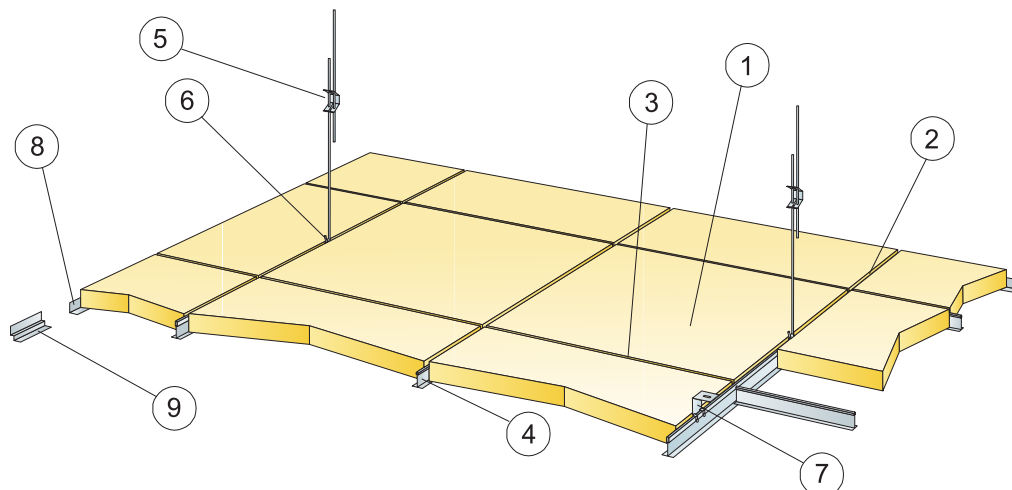

© Ecophon Group

Installation diagram (M56) for Ecophon Master A

Quantity specification (excl. wastage)

	Size, mm		
	600x600	1200x600	1200x1200
1 Master A	2,8/m ²	1,4/m ²	0,7/m ²
2 Connect T24 or T15 Main runner, installed at 1200 mm centres (max. distance from wall 600 mm, can be extended up to 1200 mm if no live load between Main runner and wall).	0,9m/m ²	0,9m/m ²	0,9m/m ²
3 Connect T24 or T15 Cross tee, L=1200 mm, installed at 600 mm centres	1,7m/m ²	1,7m/m ²	0,9m/m ²
4 Connect T24 or T15 Cross tee, L=600 mm	0,9m/m ²	-	-
5 Connect Adjustable Hanger, installed at 1200 mm centres (max. distance from wall 600 mm)	0,7/m ²	0,7/m ²	0,7/m ²
6 Connect Hanger Clip (not to be used in swimming hall environments)	0,7/m ²	0,7/m ²	0,7/m ²
7 For direct installation: Connect Direct Bracket, installed at 1200 mm centres	0,7/m ²	0,7/m ²	0,7/m ²
8 Connect Angle trim, fixed at 300 mm centres	as required	as required	as required
9 Connect Shadow-line trim, fixed at 300 mm centres	as required	as required	as required
Δ Min. overall depth of system, with adjustable hanger: 100 mm, with direct bracket: 50 mm			
δ Min. demounting depth: 170 mm, 200 mm with 1200x1200 mm			

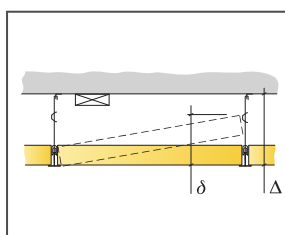

See Quantity Specification

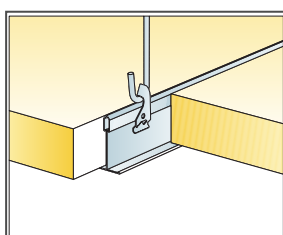

Suspension with adjustable hanger and clip

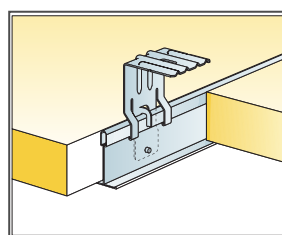

Suspension with direct bracket

Size, mm	Max live load (N)	Min load bearing capacity (N)
600x600x40	40	160
1200x600x40	40	160
1200x1200x40	40	160

Live load/load bearing capacity