

WASHTROUGH: SOLX1800SBM

SOLX1800SBM | 2030010663

PRODUCT GROUP : Wash basins | ARTICLE FAMILY : Wash troughs | ARTICLE GROUP : SOLX1800++

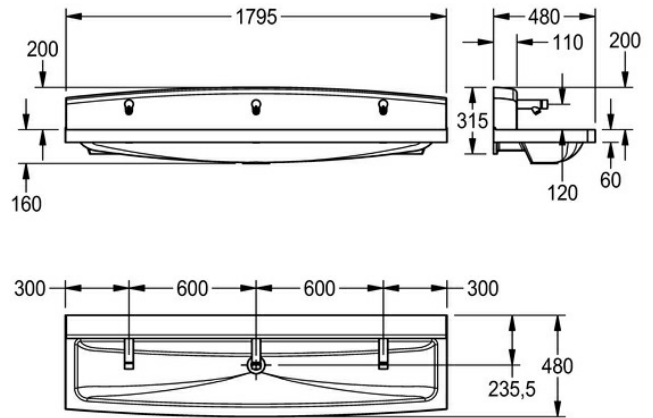

Washtrough made from Miranit resin bonded mineral material, with an alpine white gelcoat surface finish that's smooth, pore-free and temperature resistant up to 80°C. Washtroughs include a 32mm waste kit with overflow. Available with or without splashback, there is also a choice of either self-closing or electronic, touch free taps.

CE Certified

3 Person washtrough and tap landing, supplied with manual self closing mixer taps waste and overflow.
Colour: Alpine white.

3 wash places dimensions: 1800 x 480 x 170mm

TECHNICAL DATA

gross weight	60.00 kg
material	mineral material
material code	Miranit
net weight	58.00 kg
number of waste holes	1
overall depth	480.00 mm
overall height	360.00 mm
overall width	1,800.00 mm
rear upstand	no
splash back	yes
number of tap holes	3
tap ledge	no
type of mounting	wall mounting
number of wash places	3
waste hole position	centre back
waste hole projection	235.50 mm
waste kit included	yes
waste size	DN 32

WASH TROUGH: SOLX1800SBM

SOLX1800SBM | 2030010663

PRODUCT GROUP : **Wash basins** | ARTICLE FAMILY : **Wash troughs** | ARTICLE GROUP : **SOLX1800++**

SPARE PART



**SELF-CLOSING BIB TAP:
AQUA205W**

2000065911
