

Uniclass L6813	EPIC F83
CI/SfB	Y (L34)

Sika®-1 Waterproofing System

Waterproofing Above and Below Ground for both New and Refurbishment Works

Construction



- ▲ Simple 'No Sump No Pump' Technology
- ▲ 90 year Track Record
- ▲ Environmentally Friendly
- ▲ Designed for the Life of the Structure



For more information on Sika visit www.barbourproductsearch.info

The Components of Sika®-1 Water

The Sika®-1 Waterproofing System can be designed to “keep water in” or to “keep water out”.

With rising groundwater in many areas, coupled with the ever increasing commercial need to optimise land usage by creating and re-creating habitable basement areas, there is a need for effective and durable waterproofing in both new and refurbishment works.

Similarly, with ever stricter controls on water quality, many existing structures, for the retention of potable water or for the protection of ground water from effluents, will need upgrading.

Applied internally or externally, the cementitious **Sika®-1 Waterproofing System** has provided the answers for over 90 years. Using neither sumps or pumps the **Sika®-1 Waterproofing System** forms an integral part of the structure to which it is applied, and is designed to last the lifetime of that structure.



▲ Keeping Water Out

- ▲ Basements
- ▲ Underground Car Parks
- ▲ Metro Stations and Subways
- ▲ Utility Vaults
- ▲ Marine Structures
- ▲ Tunnels

▲ Keeping Water In

- ▲ Reservoirs
- ▲ Water Tanks
- ▲ Waste Water Treatment Plants
- ▲ Secondary Containment Bunds
- ▲ Swimming Pools
- ▲ Sewers and Pipelines

Sika®-1 Mortar Technology

Dense impervious mortar is produced by minimising capillaries and using pore blocking techniques.

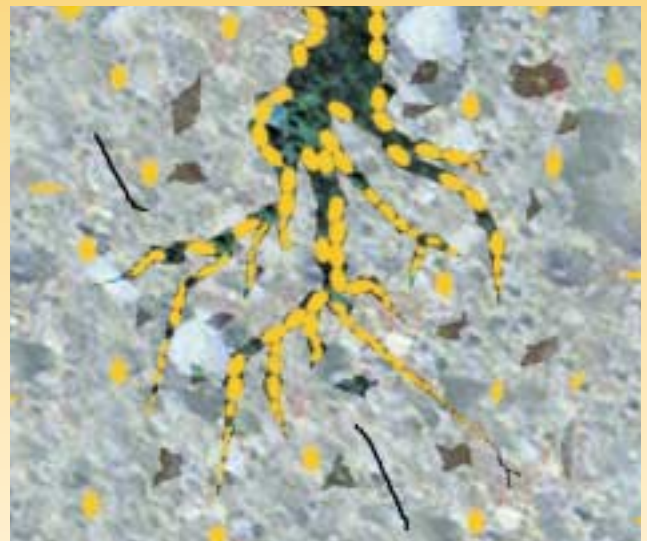

proofing System



The **Sika®-1 Waterproofing System** consists of a specialist liquid admixture and pre-bagged quality controlled mortars.

Sika®-1 mortars consist of kiln dried pre-batched precision graded aggregates and cements, in 3 easily identifiable grades with simple colour striping to ensure site quality control.

Sika®-1 admixture is a colloidal silicate liquid, diluted and incorporated into the mortar mix producing a complete waterproofing system.

Durability



“Under normal conditions of use, the **Sika® -1 Structural Waterproofing System** will provide an effective barrier to the transmission of liquid water for the life of the building to which it is applied”.

As quoted in British Board of Agrément Certificate. Number 00/3761 Section 15.

Jointing Technology

Construction joints and movement joints must be sealed using the **SikaDur®-Combiflex® System**

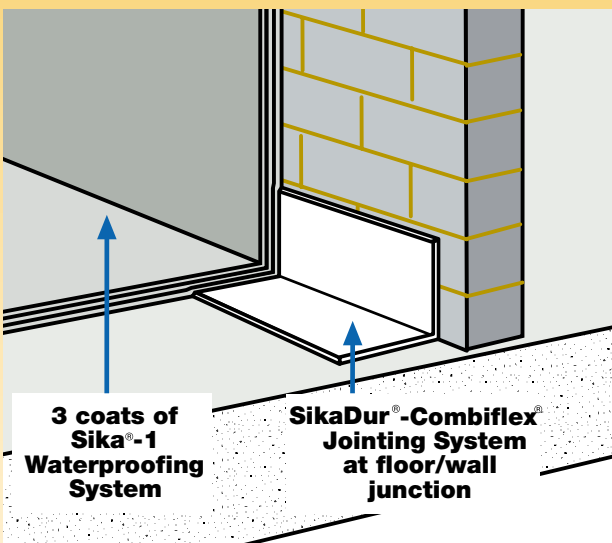

Penetrations

Pipe entries, service ducts etc must be sealed incorporating **SikaSwell®** hydrophillic profiles and **Sikaflex®** Sealants

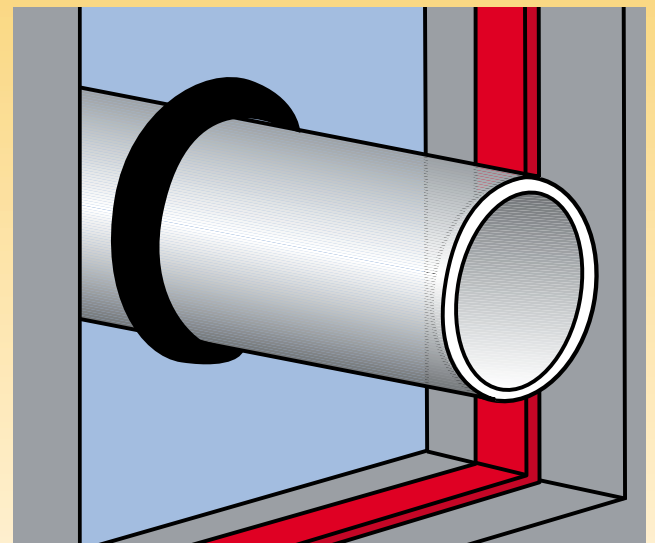

Sika® -1 Waterproofing System

Note: Full installation guide and detailing sheets for **Sika® -1 Waterproofing System** are available on request



1. All materials must be stored in clean dry conditions



2. Suitably qualified and experienced contractors should be used.



3. All surfaces must be thoroughly mechanically prepared.



7. Immediately prior to installation of **Sika® -1 Waterproofing System**, saturate the surface with clean water.



8. The first wall coat of **Sika® -1 Spritz Mortar** is "cast" vigorously onto the wall at 6mm thickness.



9. The 2nd and 3rd wall coats of **Sika® -1 Render and Finishing Mortar** are trowel applied to a minimum 6mm per coat.



13. A **Sika® -1 Bonding Coat Mortar** is brush applied as a slurry to the prepared floors.



14. The 2nd and 3rd coats of **Sika® -1 Screed Mortar** are applied to the floor by trowel and lapped onto wall finishes.

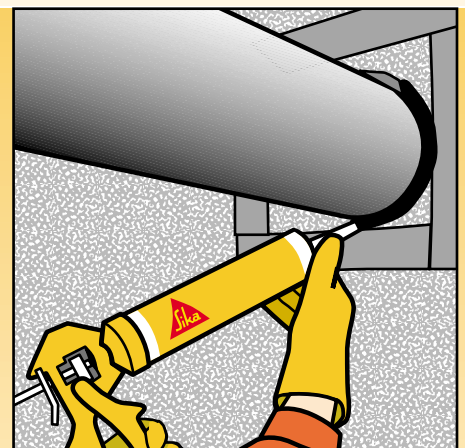

15. All service entries must be filled with **Sika® -1 Waterproofing System** and sealed using high performance sealants **Sikaflex® -11FC+**, **SikaSwell®** or **SikaDur® - Combiflex® System**.

Application Guide

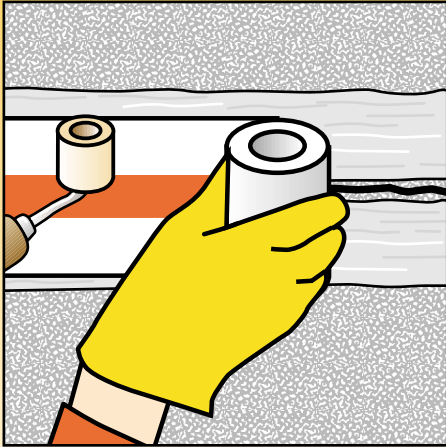

4. All joints should be protected by **SikaDur®-Combiflex® System** incorporated within the render.

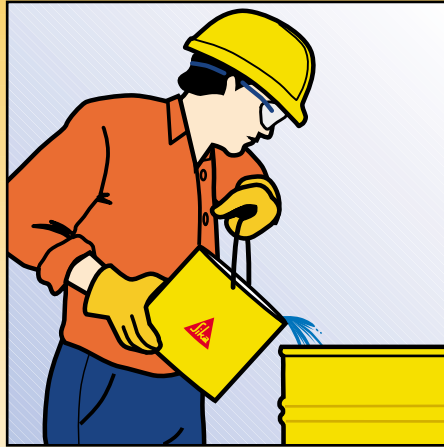

5. **Sika®-1** Waterproofing admixture should be diluted 1:10 with fresh clean water to make up a gauging solution.

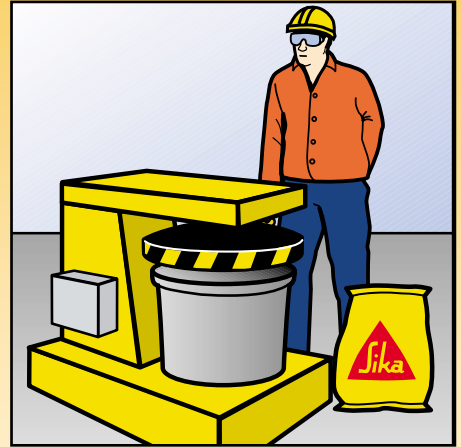

6. **Sika®-1** pre batched **Mortars** must be mixed in forced action mixers using **Sika®-1** gauging solution.

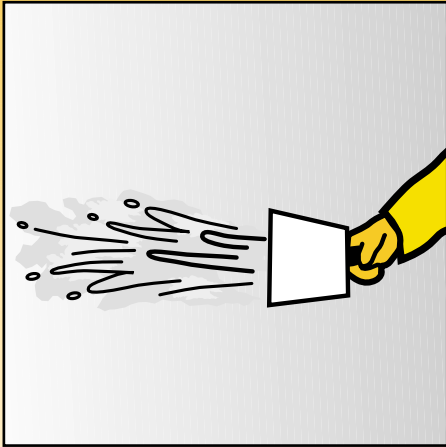

10. Keying between trowelled mortars is achieved by application of splatter coats of **Sika®-1 Spritz Mortar**.

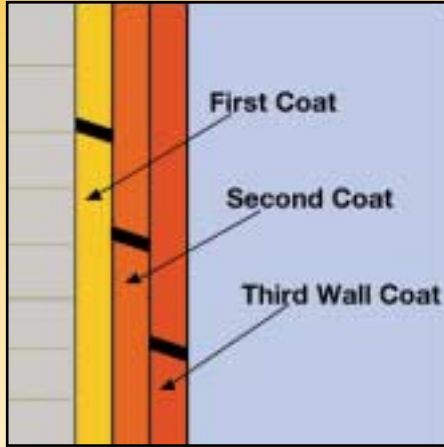

11. Dry joints in wall finishes should be lapped by a minimum of 100mm. Similarly wall finishes should be lapped onto floors.

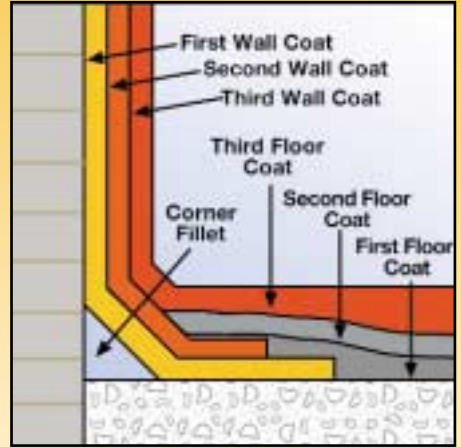

12. If no **SikaDur®-Combiflex® System** joint is used at floor/wall interface, a **Sika®-1 Render Mortar** corner fillet must be included.

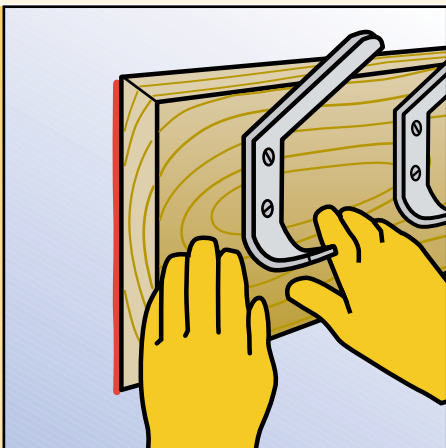

16. Fixings must be secured using **SikaDur®-31**, **Sika Powerfix®** resin adhesives, or **Sikaflex®-11FC+** polyurethane adhesive sealants.
Do Not Drill into system



17. Final plaster finishes suitable for decoration can be produced with **SikaMur® Finish**.

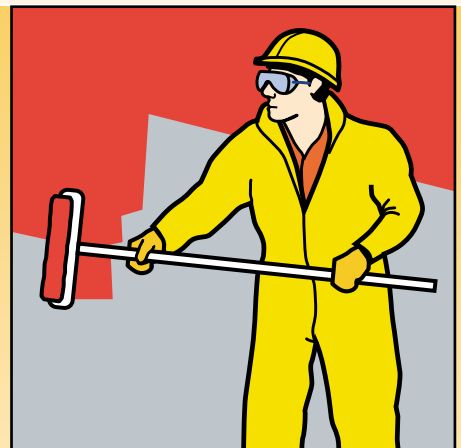

18. For additional demands such as mechanical and chemical resistance, or crack bridging etc; use compatible **SikaGard®** or **Sikafloor®** coatings.

The Requirements for Waterproofing Basements

(BS 8102 - 1990). Code of Practice for Protection of Structures Against Water from the Ground



Grade
1

Typical Structure & Requirements

Basic utility.
Basement Car Parks.
Plant rooms (excluding electrical equipment).

BS 8102:
Grade 1: Slight seepage and damp patches are tolerable.

Sika® Solutions

- **Sika®-1 Waterproofing System**
- **SikaDur®-Combiflex® System**



Grade
2

Residential and Commercial Basements
Workshops, plant rooms and retail storage where a drier environment is required.

BS 8102:
Grade 2: No water penetration but moisture vapour tolerable.

- **Sika®-1 Waterproofing System**
- **SikaDur®-Combiflex® System**



Grade
3

Ventilated residential and working areas including offices, restaurants and leisure facilities.

BS 8102:
Grade 3: A dry environment is required and water penetration is intolerable.

- **Sika®-1 Waterproofing System**
- **SikaDur®-Combiflex® System**



Grade
4

Use for archives, storage of sensitive material, i.e. computer rooms.

BS 8102:
Grade 4: A totally dry environment. Vapour impermeable.

- **Sika®-1 Waterproofing System**
- **SikaDur®-Combiflex® System**
- **Sika® EpoCem® Systems**
- **SikaDur® Liquid Damp-Proof Membrane**
- **SikaGard® Coatings**



Additional performance requirements

- ▲ Hygienic and easy to clean
- ▲ Approved for contact with drinking water
- ▲ Crack bridging
- ▲ Chemically resistant
- ▲ De-icing salt resistant
- ▲ Waste water resistant

Sika® Solutions

- **Sika®-1 Waterproofing System and joint sealing systems as Grade 3 and 4 above.**
Plus:
- **Sika® EpoCem® Systems**
- **SikaTop® cementitious render** dependent on the specific requirements.
- **SikaGard® coatings**

Sika® Vapour Barrier Systems

- ▲ Impermeable Moisture Barriers
- ▲ Solvent Free
- ▲ Fast Track Construction
- ▲ Unique Sika® Epocem® Technology



Where total vapour impermeability is demanded in addition to structural waterproofing as part of a Grade 4 system under BS 8102, this can be achieved by using a **Sika®** Vapour Barrier System.

Sika® Vapour Barrier Systems comprise **SikaGard®-720 EpoCem®** for walls and **Sikafloor®-81 EpoCem®** for floors sealed with solvent free **SikaGard®** and **Sikafloor®** epoxy resin coatings.

SikaGard® and **Sikafloor® EpoCem®** provide a temporary moisture and vapour barrier allowing the application of the appropriate **SikaGard® / Sikafloor®** solvent free epoxy resin coating to produce a permanent and moisture vapour resistant finish.

Similarly, this system can be used on new concrete structures where residual moisture levels are too high for the installation of finishes.

Alternatively, **SikaDur® Liquid Damp-Proof Membrane** can be installed where there is no current anticipated water pressure to help achieve a Grade 4 installation under BS 8102 – please contact Sika for full technical advice.

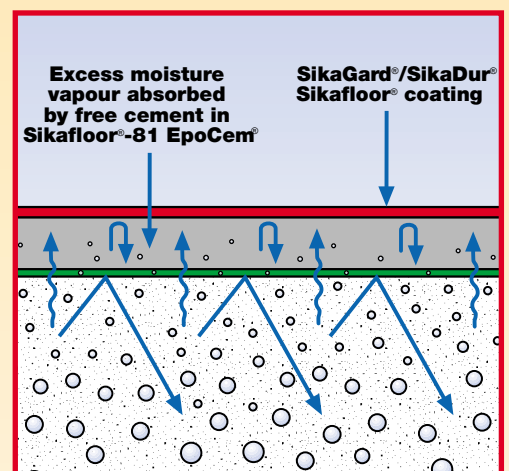

Sika®-1 Waterproofing System Case Studies

Deptford Town Hall London

Problems

- ▲ Now part of Goldsmiths College, the Old Town Hall at Deptford has a basement constructed from brickwork which provided an ideal area for conversion into a national archive for the storage and study of historic fabrics.
- ▲ As with many 19th Century basements, over the years, the original waterproofing had become ineffective with evidence of damp and water ingress causing severe deterioration to the building fabric.



Requirements

- ▲ Complete internal waterproofing system.
- ▲ Proven 'last the lifetime of the building' system to protect valuable artefacts.
- ▲ Totally controlled environment to Grade 4 use in accordance with BS 8102.
- ▲ Smooth plaster finish ready to accept decoration.



Sika® Solutions

- ▲ All exposed brickwork repaired, re-pointed and bush hammered to provide a rough surface.
- ▲ Existing concrete floor mechanically cleaned.
- ▲ **SikaDur®-Combiflex System** to all potential movement joints.
- ▲ **Sika®-1** three layer waterproofing system to floors and walls.
- ▲ 2 coats of **SikaDur® Liquid Damp Proof Membrane** to provide vapour barrier.
- ▲ Finished surface provided by **SikaMur® Dry** and **SikaMur® Finish** renovating plasters.
- ▲ All materials installed to provide Grade 4 of BS 8102



Sika®-1 Waterproofing System Case Studies

Wellington Arch War Memorial London

Built in 1928 to commemorate
the Battle of Waterloo

Refurbishment Project completed 2000

Problem

- ▲ Previously used for storage by Park Rangers from the nearby Hyde Park the memorial had been left unoccupied for years allowing water penetration into the basement and subsequent deterioration of the internal building fabric.

Requirements

- ▲ As part of a full scale renovation for the millennium by English Heritage, the leaking basement was to be converted to a clean, dry visitor centre.
- ▲ Provide a permanently dry underground structure for commercial use, including offices and toilets. In accordance with Grade 3 BS 8102.
- ▲ To ensure water tight connections between new suspended floor slabs and existing walls
- ▲ Maintain the historic character of this listed structure.

Sika® Solutions

- ▲ Full mechanical preparation of all barrel vaulted basements
- ▲ **Sika®-1** three layer waterproofing system to floor and walls
- ▲ Installation of **SikaDur® Combiflex® System** at wall to floor connections.
- ▲ **Sikaflex®-11FC+** fast curing one part polyurethane elastic sealant adhesive for fixing skirtings and architraves.
- ▲ All materials installed to provide Grade 3 of BS 8102.



Sika®-1 Waterproofing System Case Studies

The Vaults Trinity Street Cambridge

Refurbishment Project completed 2000

Problem

- ▲ Availability of quality commercial properties in this University City are at a premium and optimum use of all floor space is crucial. This often involves using existing basements for a wide variety of uses.
- ▲ The original solid brick masonry walls had no form of external waterproofing, relying solely on the interlocking brickwork.

Requirements

- ▲ To convert a damp, dreary brick vaulted basement into a light airy Café Bar
- ▲ Complete internal waterproof system
- ▲ To accept ceramic floor tiles
- ▲ Suitable for internal decorative finish
- ▲ Last the lifetime of the building
- ▲ Provide Grade 3 use in accordance with BS 8102.

Sika® Solutions

- ▲ All existing lime wash coatings mechanically removed and existing brickwork mortar joints raked out and re-pointed.
- ▲ Exposed brickwork bush hammered to provide a rough textured surface.
- ▲ **Sika®-1** three layer waterproofing system to floor and walls, suitable to accept final finishes.
- ▲ Completed systems provided waterproofing in accordance Grade 3 of BS 8102.



Other Sika Damp-Proofing Solutions

Sika® Damp-Proofing Slurry

- ▲ Pre-bagged polymer modified cement mortar slurry
- ▲ Simple, just add water, technology
- ▲ Brush, trowel or spray application
- ▲ Two layer application to provide permanent damp-proof finish
- ▲ Acts as a waterproof lining for ponds, tanks, pools etc.



Sika® Inertol 49W Thick

(Sika® Liquid Asphaltic Compound)

- ▲ One pack phenol-free coating complying with BS 3416 Type II
- ▲ Waterproof treatment to foundation walls, and general concrete / steel structures above and below ground
- ▲ Provides a DPM for ground floors



SikaMur® Ventilating Plaster System

- ▲ Internal and external re-plastering of masonry walls
- ▲ Prevents migration of soluble salts following flood damage or DPC injection
- ▲ Limestone based - ideal for Heritage works
- ▲ Fine finish plaster to produce a smooth surface for decoration



Additional Sika® Technologies and Solutions



Sika® Waterstopping Systems



Range of quick setting liquid additives for leak sealing and rapid plugging.



SikaBond®



Permanently elastic polyurethane bonding systems for solid wood and parquet flooring.



Range of one component polyurethane based construction joint sealants with classifications to ISO 11600 selection criteria



SikaTack® Panel System



Elastic bonding of façade cladding. Suitable for most pressure ventilated curtain walling. No visible mechanical fixings and suitable for aluminium or timber framework. Elastic bonding allows for load transmission and avoids stress fatigue at screw fixings



SikaFloor®

Range of high performance flooring systems for the most demanding industrial and commercial installations



Sika® Membran System

Highly elastic vapour barrier system for use in glass curtain walling or infill windows. Polyurethane elastic adhesives allow re-positioning of membrane. Internal and external grades for insulated cavities.

Construction

The information, and, in particular, the recommendations relating to the application and end-use of Sika products, are given in good faith based on Sika's current knowledge and experience of the products when properly stored, handled and applied under normal conditions. In practice, the differences in materials, substrates and actual site conditions are such that no warranty in respect of merchantability or of fitness for a particular purpose, nor any liability arising out of any legal relationship whatsoever, can be inferred either from this information, or from any written recommendations, or from any other advice offered. The proprietary rights of third parties must be observed. All orders are accepted subject to our current terms of sale and delivery. Users should always refer to the most recent issue of the Technical Data Sheet for the product concerned, copies of which will be supplied on request.



INVESTOR IN PEOPLE

Environmental



Protection

Quality



Production

Sika Limited

Watchmead, Welwyn Garden City,
Herts, AL7 1BQ
Fax: 01707 329129
Telephone: 01707 394444
e-mail: sales@uk.sika.com

Sika Ireland Limited

Unit 3 Ballymun Industrial Estate,
Dublin 11, Ireland
Fax: (01) 8620707
Telephone: (01) 8620709
e-mail: info@sika.ie



For more information on Sika visit www.barbourproductsearch.info