

Versatile solutions

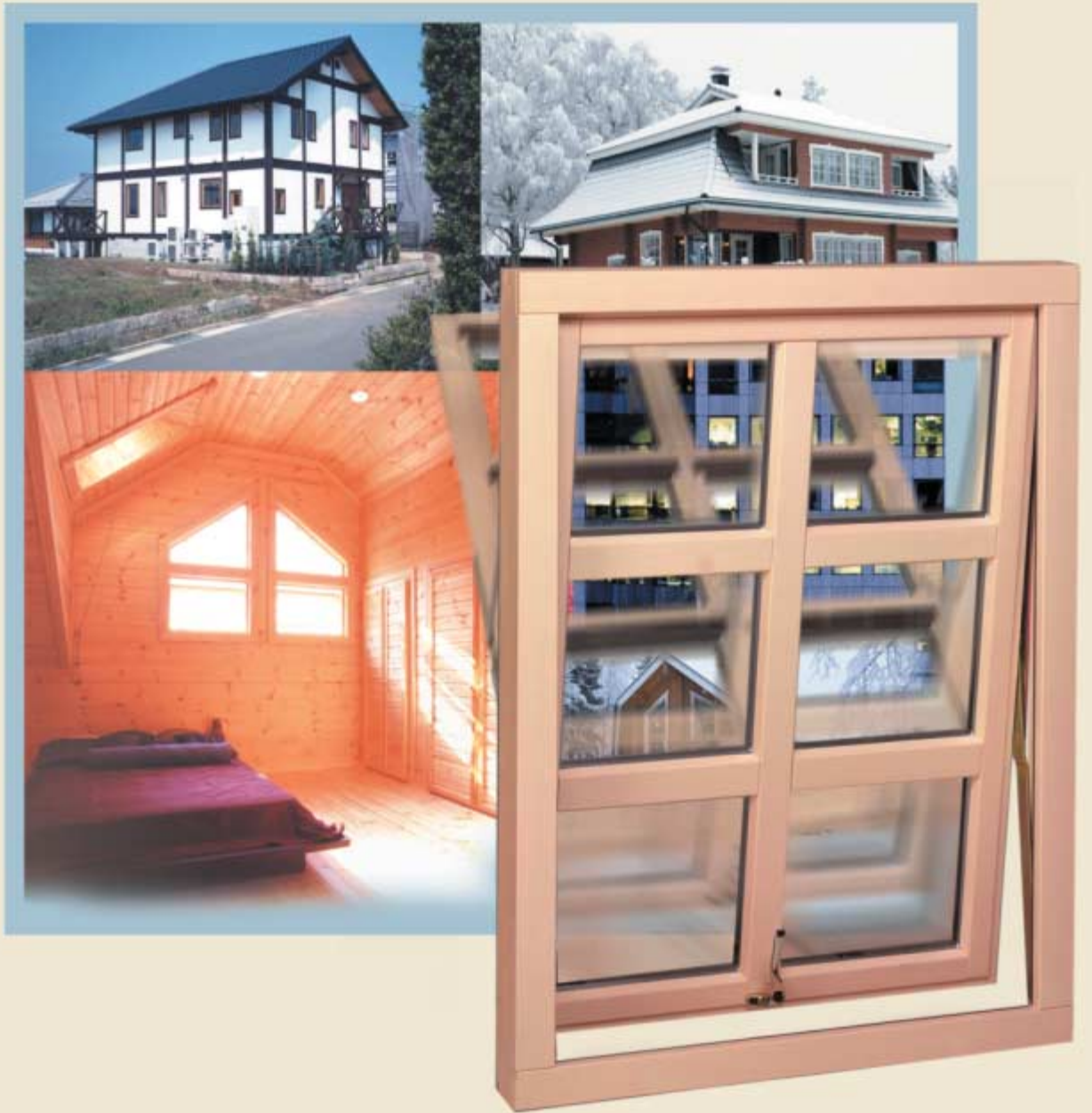

SKAALA[®]

OUTWARD OPENING
WINDOW SYSTEM

Skaala windows, easy to live with, safe, and energy efficient

Functional perfectness

Skaala Outward opening windows fulfil and surpass the many demands that the changing European climate makes on a window. Besides weather resistant, they are energy saving and safe.

Skaala windows have been developed in accordance with the principles that Skaala has followed from the very beginning.

This includes the use of first class materials, full architectural freedom, perfect tightness, optimum safety and, above all, that the products are easy to use.



Skaala Outward opening window – Many options for different needs

Skaala is one of leading window and door manufacturers in Scandinavia. Because the functionality and requirements of window vary country by country, Skaala has developed this window system for specific markets where an outward opening window is required through tradition, or choice. The firm structure of three layer laminated Nordic pine prevents twisting and offers accurate dimensions. Together with top class fitting system, it qualifies even in big windows, in all surroundings, year after year. Every window has been precisely adjusted at the factory. The one handle system leaves also more space for the elegant wood surface.



Unified profile system - different functions

The five different opening systems gives you wide choice and a freedom to design to you or your clients building requirements and lifestyle:

Top Turn 180 (TT180)

Top hung reversible windows.
Safe and smooth operating action.
Integrated restrictor and stay for vent opening.
Window heights 600 -1600 mm.
Casement weight 60 kgs.

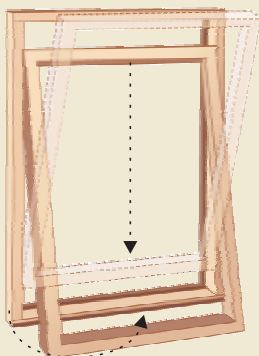

Side Turn 90° (ST90°)

Side hung easy clean windows.
Casement directly supported by the cill.
Smooth action with adjustable friction.
Fire egress opening.
Window widths 400 -900 mm.
Casement weight 50 kgs.

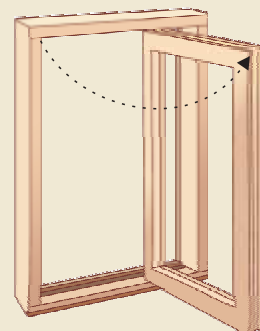

Top Turn 45° (ST45°)

Top hung easy clean windows.
Window heights 300-500mm.
Projecting top hung windows.
Window heights 500-1600mm.
Smooth action with adjustable friction.
Integrated restrictor and stay for vent opening.
Casement weight 40-60 kgs.

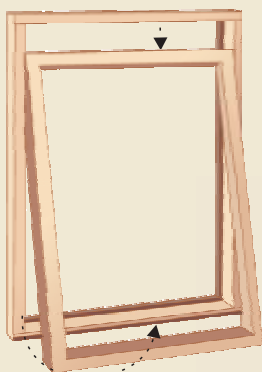

Side Turn (ST)

Handed hinge.
Self locating on UNI groove.
Fire egress opening.
Window widths 400 -900 mm.
Casement weight 40 kgs.

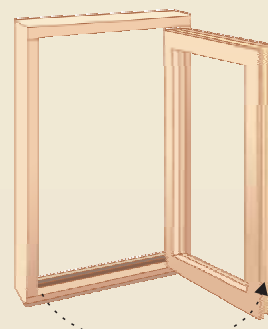

Side Turn 180 (ST180)

Side hung reversible windows.
Safe and smooth operating action.
Restrictor and reverse catch.
Fire egress opening.
Window widths 400 -1200 mm.
Casement weight 50 kgs.

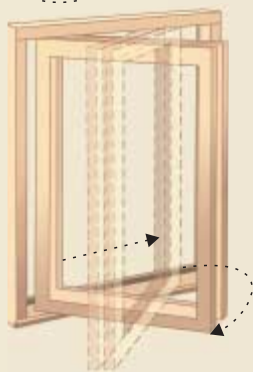

Skaala - tailored to suit every house

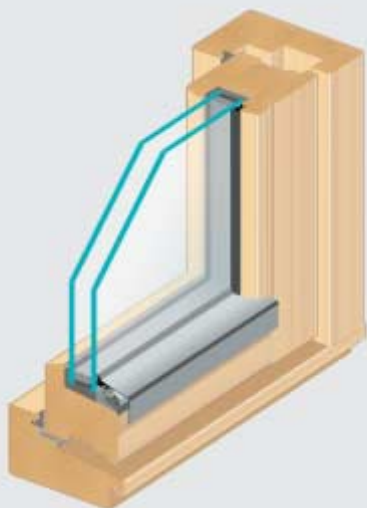

Top Turn 180 (TT180), viewed from outside

Test results, air permeability

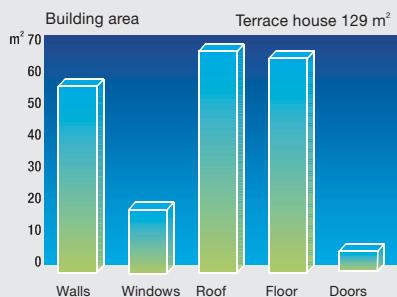
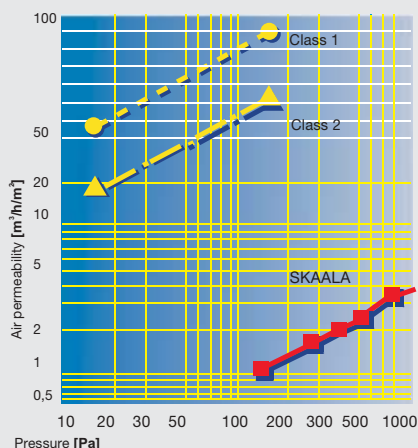

On U-Value ~1,0 W/m² the loss of energy of the windows lessens to the same level with other parts of the building.

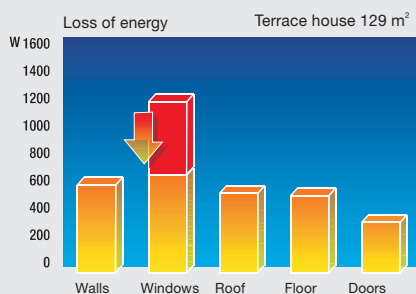

Source: Pilkington

The Skaala outward opening windows are always tailor-made, not only for new houses but also for old buildings in need of restoration. For your windows you can choose any dimensions, appearance or colours.

1. Timber and structure

The three layer laminated Nordic pine ensures that the window remains strong, stable and durable. There is no plugging on the exposed surfaces.

2. Fittings

PN Uni gear, type according to function (TT180, TT 45, ST180, ST90, ST): Standard handle included into delivery. Standard colour brass, white or gray.

3. Sealing

One sealing

4. Glazing

Full flexibility in selection of glass. Sealed double glazed unit as a standard.

- Low E-glass
- Low E-glass+argon
- Toughened / laminated
- Obscure
- Sound insulation
- Solar control

Glazing from outside. Secured with sturdy list, silicon and sealing.

With the spacer in the glazing unit you can give your windows a harmonious and individual expression.

Standard colours: brown, white, and natural. Other colours on request.

5. Surface treatment Oil-based preservative always as a base. Full factory finish available: stain, lacquer and paint. Modern technology provides a better guarantee for an excellent and durable finish. There is also the additional ecological benefit of minimised waste.

6. Ventilator as an option

(UK as a standard).

7. Standard and lockable handles as required

8. Accessories

Child safety restrictors, extension sills, mosquito nets, windowbenches inside.

9. Astragals

Skaala provides three astragal options: traditional solid glazed bars, applied to the glass astragals and clip-on astragals.

10. Mix & Match

Fixed windows that are compatible with the outward opening windows can be delivered either integrated or separately.

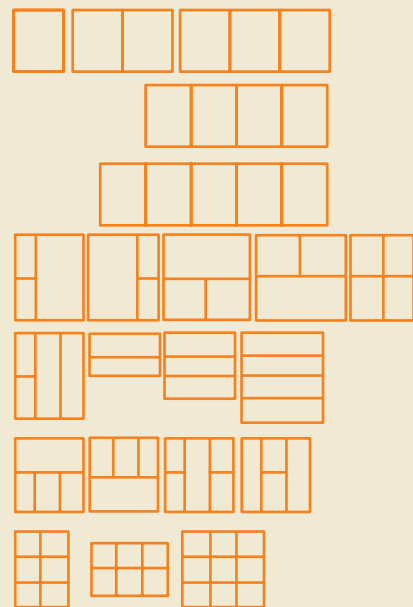

Skaala - naturally!

Another commitment of Skaala is Customer Designed Deliveries. The whole production process is built on the customers' requirements and every window model that has been ordered from Skaala is individually handled and accurately delivered according to schedule.

The raw material of all wooden parts is the slow-growing Finnish pine, a renewable natural resource from the well

maintained forests. The surface treatment system is one of the most modern in Europe, which enables Skaala to use both water and oil-based materials with great flexibility.

Skaala product range is tested to fulfil European norms and requirements.

The whole process is managed by certified Quality System EN ISO 9001.

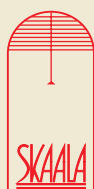

Certificated Quality System

Skaala Windows and Doors

P.O.Box 17
FIN-62375 Ylihärmä
Telephone +358-(0)6-4822 000
Fax +358-(0)6-4846 950
www.skaala.fi
name.surname@skaala.com