

YOUR  
**ENTRY**  
EXPERTS.



MEDIUM LEVEL SECURITY



# SPEEDLANE COMPACT.

THE **SHORTEST** 'NO-NONSENSE' SECURITY SPEED GATE

The newest addition to the Boon Edam premium range of speed gates solves the issue of introducing security and safety into small and valuable areas of real estate spaces. The Speedlane Compact delivers all you fundamentally need in a security lane; while confidently delivering all that is required to make your visitors feel welcome and secure - every day.





## OVERVIEW

The Speedlane Compact is a trendy and functional addition to increasing security levels in your valuable area. Ease of efficiency in moving people safely onto the next point of their journey is in no way compromised by this speed gate's small footprint. Advanced algorithms and technology ensure smooth and accurate passage.

Speed gates are gaining in popularity as busy work and public spaces have to remain safe and secure. The Speedlane Compact offers excellent support to guards and staff responsible for authorised entrances to secured areas.

## PREMIUM MINIMALISM AND STYLISH SOPHISTICATION

The Speedlane Compact has been designed with simplicity and sophistication in mind. The minimalist lines of the cabinets fit into almost any area without drawing unnecessary attention to themselves.

Contoured cabinets, position and operation of directional LED lights guide even an untrained user through the passage with pleasant ease. However, as simple as the product is to use, the premium integrated technology still offers excellent tailgating detection and safety sensors as standard features.

## UNCOMPLICATED EASY AND EFFECTIVE

The Speedlane Compact has one word which resonates so perfectly with it - ease. Ease of integration with many access control systems and technology provides a lot of flexibility when considering adding it to your total security solution.

The speed gate is easy to install, to maintain, and the short delivery turnaround times are very attractive.

This medium security solution does what it needs to do with quiet confidence. There is no need for excess here. This is basic, done well.

## KEY FEATURES

- Intuitive user guidance
- Tailgating, safety and object detection sensor sets, as standard
- Easy installation
- Generous interior space cabinet for flexible ACS integration
- Premium quality materials
- Smooth, swing motion glass barriers
- Short V-shaped cabinet with ergonomic design and small footprint
- Flexible lane configurations (including a wide lane for disabled and large object access)
- Universally understood and proven display symbols
- Additional flexible options available to fine-tune or 'Level Up'

### KEY BENEFITS

- Relieves pressure from security or reception staff
- Coordinates beautifully with existing building décor and design
- Short cabinet length optimises the use of valuable floor space
- Built to last

### SUGGESTED SEGMENTS

- Corporate offices
- Universities and education facilities
- Gyms and sports centres
- Casinos
- Retail (Stop 'n Shop)

### SCALABLE FLEXIBILITY IS THE FUTURE

The ability to integrate a large variety of secondary security technology into our speed gates is the ideal way in which to fine-tune by 'Leveling Up' their entrance security when increased protection is required.







Meeting your security goal easily and within your budget is the reason why we work together with you to ensure that by using these options, you end up with a product that outperforms the others safely, beautifully and profitably.



### PART OF THE BIGGER PICTURE

Boon Edam products form part of the overall security of a facility, especially when we are talking about the introduction of medium-level security in the form of speed gates. The Speedlane Compact provides the vehicle to integrate a huge array of modern and technologically advanced devices to mitigate risk. We work closely with suppliers of devices such as card readers, barcode scanners, keypads, video surveillance, etc., and have spent years building good relationships to help our customers get even more out of their Boon Edam entrance solutions.

You can level up in any of these categories:

-  THROUGHPUT
-  SECURITY
-  SAFETY
-  AESTHETICS
-  TECHNOLOGY
-  COMFORT
-  SERVICE

# LEVEL UP



If our standard specifications do not quite suit your needs, we open up opportunities for you to 'Level Up' where it counts most. You can also do this according to your most motivating value driver.

The specification table shows you our standard product options, and to the right of these, you can easily see, and consider, any compatible 'Level Up' options for fine-tuning the Speedlane Compact.



## TECHNICAL SPECIFICATIONS

 THROUGHPUT	STANDARD	LEVEL UP OPTIONS
Throughput	20 - 30 People per minute	
Cabinet Width	150 mm	
Cabinet Height	990 mm	
Cabinet Length	1200 mm	
Passage Width	615 mm	Wide: 915 mm
Overall Lane Width	1065 mm (for a single lane)	Wide: 1365 mm
Wing / Barrier Height	890 mm	High: 1800 mm
 SECURITY	STANDARD	LEVEL UP OPTIONS
Unauthorised User Detection	Complete sensor set	
Booking Signal	Adjustable booking signal	
Sound Alarm	Sound module	
Tailgating Detection	Standard Range	
 SAFETY	STANDARD	LEVEL UP OPTIONS
Fail Safe Operation	In case of power outage	
Fire Alarm Connection	Emergency egress settings depending on local regulations and or customer request	
Safety Sensors	Complete sensor set	
 AESTHETICS	STANDARD	LEVEL UP OPTIONS
Cabinet Material	Stainless steel	
Cabinet Colour	Standard stainless steel	Other Colours: On special request Branding: On special request
 TECHNOLOGY	STANDARD	LEVEL UP OPTIONS
Power Supply	110-240 VAC, 50 / 60 Hz	<b>INTEGRATION OPPORTUNITIES:</b> <ul style="list-style-type: none"> <li>Lifeline Boost Mount (3 options)</li> <li>BoonTouch External Control Panel (up to 6 lanes)</li> </ul>
Operating Power	60W	
Operating Temperature	-15°C to +50°C	
Weight	100 kg	
Access Control Systems	Dry contacts for virtually any access control device	
Card Reader Mount	Under the top of the cabinet. Max. dimensions: 90 x 200 x 70 mm (W x L x H)	
 COMFORT	STANDARD	LEVEL UP OPTIONS
Disabled Access	Wide passage width option suitable for disabled access	Winglock Swing access gate Passage width 915 mm
Intuition	Feedback signals / Intuitive symbol design	
Stand-by Power Consumption	Stationary 50W	

## 6 WORKING PRINCIPLE

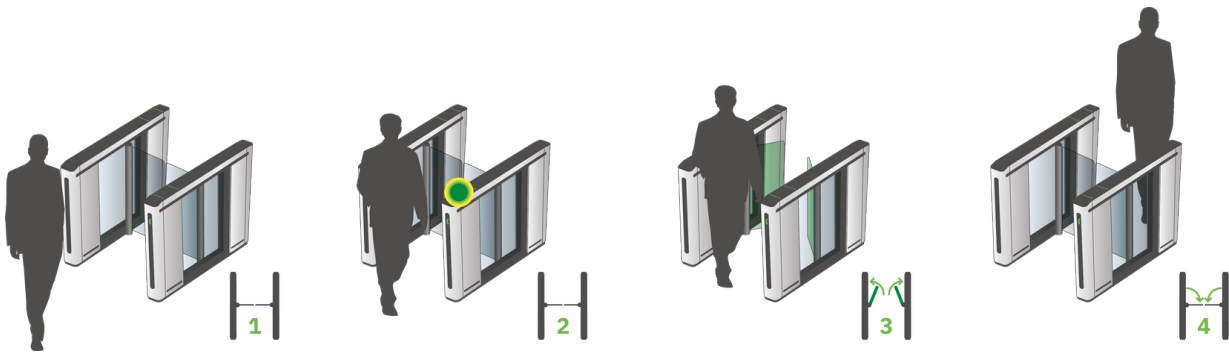

## TECHNICAL DIMENSIONS

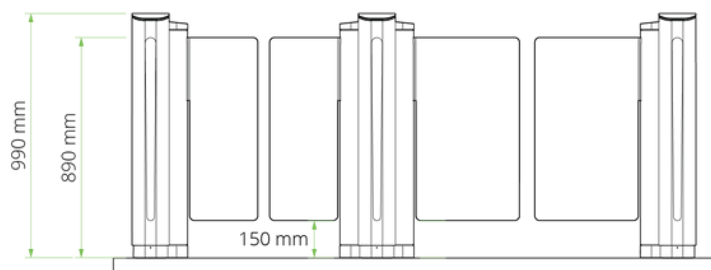
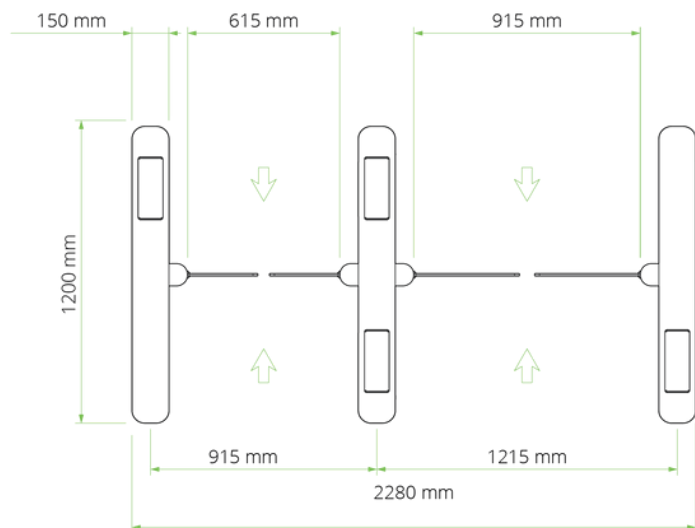
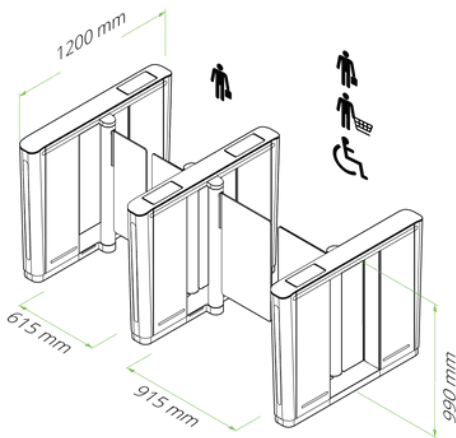
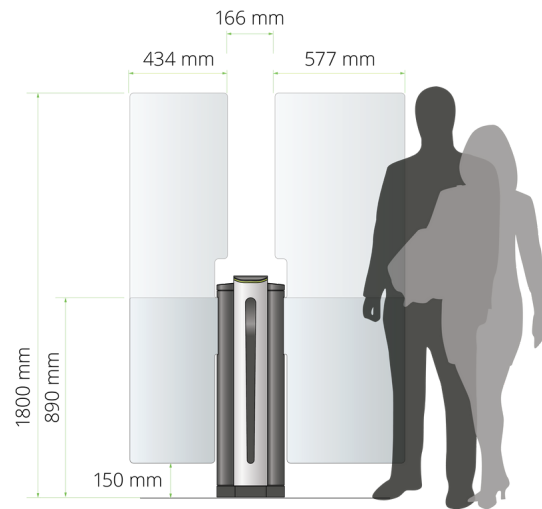

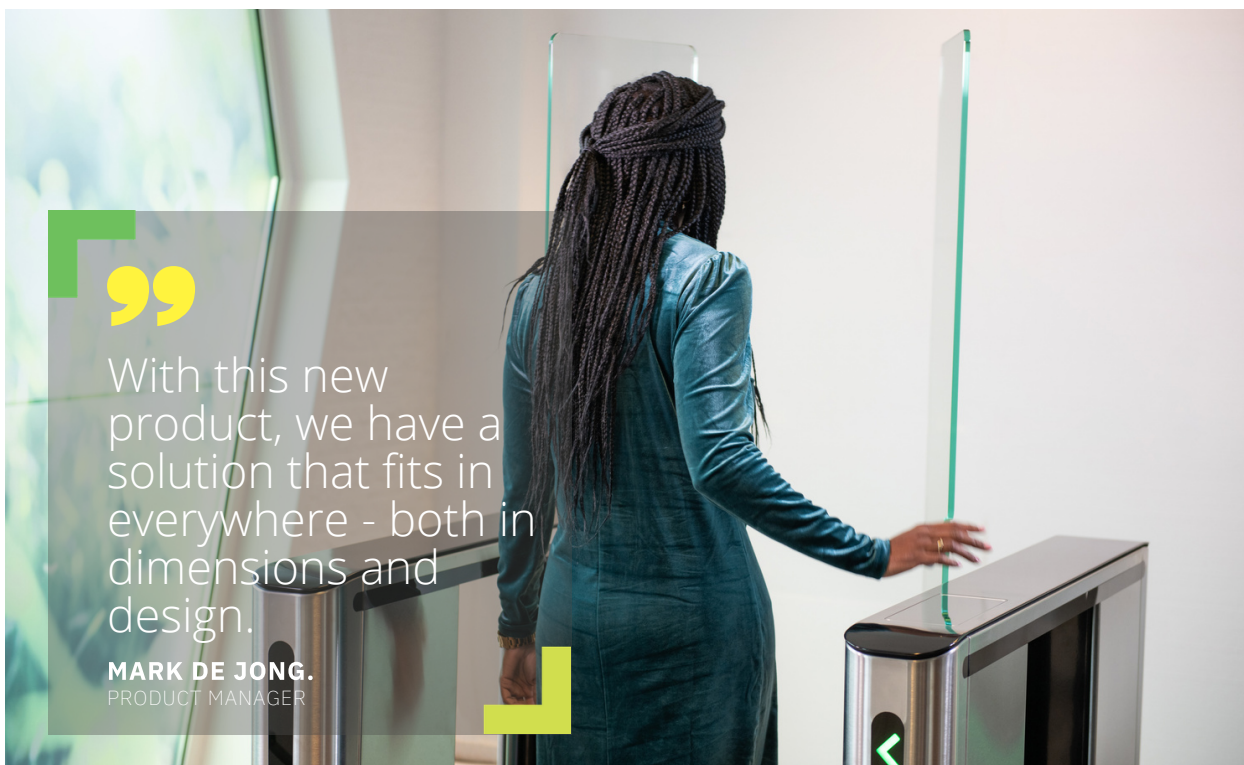

“  
With this new product, we have a solution that fits in everywhere - both in dimensions and design.

**MARK DE JONG.**  
PRODUCT MANAGER

## SERVICE AND MAINTENANCE

With hundreds or thousands of visitors passing through an entry every day, continued and reliable operation is vital. Regular service and maintenance can prevent unexpected hardware breakdowns. Boon Edam's service and maintenance teams across the world are experienced in the effects the local conditions have on the wear and tear of your entry solutions and can offer specialised service and maintenance contracts that correspond to those conditions perfectly.

## COMPLIANCE

The goal of an organisation is to safeguard the valuable assets inside – both people and property. As is often the case, industries must comply with relevant local and global laws, policies and regulations, to achieve the important goal of overall safety and security. Failure to meet the appropriate measures and criteria set out in these regulations could result in catastrophic incidents and substantial fines.

Boon Edam security entrances are trusted solutions that allow organisations to meet compliance regulations related to restricting access to areas within a building. We take compliance and safety very seriously and ensure that our products are manufactured, installed and maintained to keep up the strict criteria required in all our countries. We are always improving and always committed to making sure our products are compliant and certified. More information can be found on our website under 'About Us'.

### **The Speedlane Compact complies with the following European standards:**

- Machine Directive (2006/42/EC)
- EMC Directive (2004/108/EC)
- RoHS Directive (2011/65/EU)



# OUR REACH IS GLOBAL.

---

We have been in business for more than 140 years manufacturing premium aesthetic and security entrance solutions in the Netherlands, United States of America and China. We can confidently say that we cover every corner of the globe with subsidiary companies in major cities across the globe. Furthermore our global export division not only partner with our distributors, but also offer direct sales and service to every territory. This wide net allows us to have a strong global footprint as well as a personal grasp of local markets and their unique entry requirements.

To find your closest Boon Edam expert, please go to:  
[www.boonedam.co.uk/contact](http://www.boonedam.co.uk/contact)



**Boon Edam Limited.**  
T 01233 505 900  
E [uk.sales@boonedam.com](mailto:uk.sales@boonedam.com)  
I [www.boonedam.co.uk](http://www.boonedam.co.uk)

  
**BOON EDAM**  
YOUR ENTRY EXPERTS.