

ProFin[®] BL24/49

Push-on facing plates in 24 mm and 49 mm and associated connectors for modular Gutjahr balcony systems.

DESCRIPTION

Aluminium powder-coated, push-on facing plate for ProFin[®]DP drainage profiles which form part of the Gutjahr external tiling system from BAL. For full installation advice and technical assistance the please refer to Part A Technical Design Guide or contact the BAL TECHNICAL ADVISORY AND SPECIFICATION SERVICE.

Product Properties and Benefits

- Push-on facing plate in combination with ProFin[®] DP11/DP21/DP30 base profile for covering constructions up to 79mm high.
- Seepage water is concealed and drained behind the facing plate.
- Separating the facing plate from the base profile reduces the risk of damage from shear stress on the seal.
- Can be used with all Gutjahr surface drainage systems and DiProtec[®] sealing tape technology.

PRODUCT INFORMATION

Composition: ProFin[®] BL24/49 profile, Corner 90° and connectors are constructed from power coated aluminium.

Colour: Alumetallic. Other colours available on request.

Size: 1 length = 3 m. 1 corner unit = 185 mm x 185 mm

Additional Information:

- Height of structure: depending on type of construction and covering.

ProFin[®] BL 49
Facing Plate

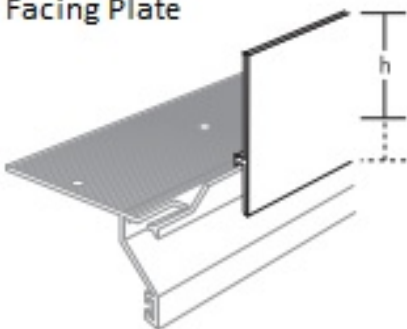



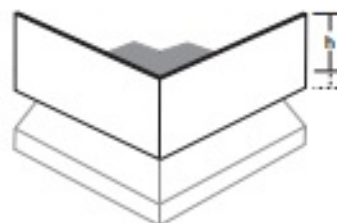

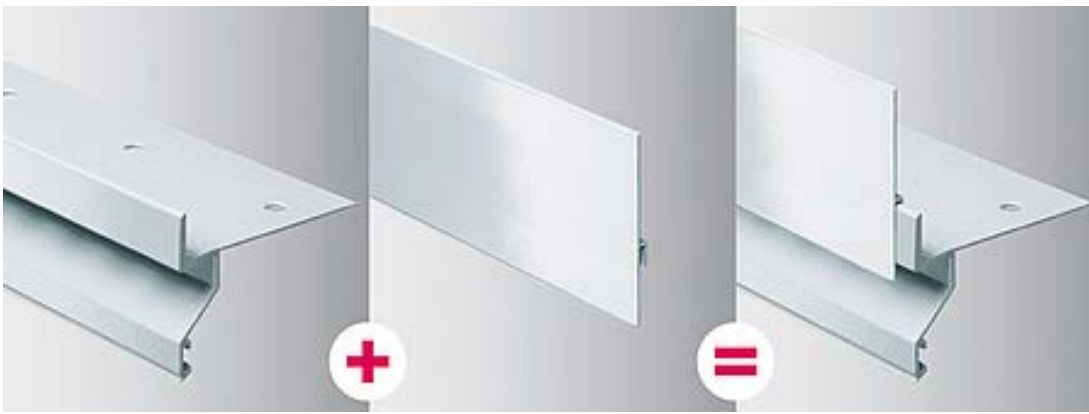



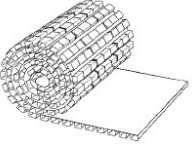

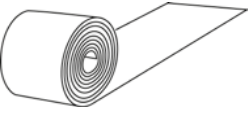
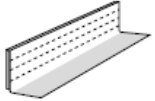

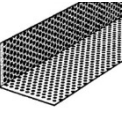

ProFin[®] BL 49
Corner 90°





OPTIONAL SYSTEM COMPONENTS

<p>AquaDrain® EK or T+ drainage mat</p> 	<p>DiProTec® AB-KV sealing tape</p> 	<p>AquaDrain® SK joint tape</p> 	<p>AquaDrain® Edge insulation tape</p> 
<p>AquaDrain® TM or FLEX drain grate</p> 	<p>AquaDrain® Lochwinkel screed angle</p> 	<p>ProRin® BR guttering</p> 	<p>ProFin® DP edge profile and BL facing plate</p> 
<p>BAL Tank-it</p> 	<p>MorTec® DRAIN</p> 	<p>BAL Quickset Cement</p> 	<p>BAL Rapidset Flexible Fibre</p> 
<p>BAL Stone and Tile PTB</p> 	<p>BAL Micromax2 Grout</p> 	<p>BAL Micromax Sealant</p> 	<p>MorTec® SOFT silicone sealant</p> 

N.B Please consult BAL Technical Advisory and Specification Service (TAS) or a member of the BAL specification support team for a full and comprehensive product specification to meet your project requirements.

TECHNICAL ADVISORY SERVICE

For free expert guidance on use of this product, or any aspect of tiling, contact the BAL TECHNICAL ADVISORY AND SPECIFICATION SERVICE on Tel: 01782 591120 or 0845 600 1 222 or Fax: 01782 591121.

SHELF LIFE

No shelf life when stored under normal conditions..

Protect from frost, damp and sunlight.

QUALITY AND ENVIRONMENTAL STANDARDS

Manufacturing quality assurance standards conform to BS EN ISO 9001. Satisfies the environmental management requirements and operational scope of ISO 14001.

6 YEAR GUARANTEE

Since 1990, GUTJAHR has been the only manufacturer to offer extended warranties for its drainage systems, e.g. 6 years for balconies, patios and outdoor steps with AquaDrain® drainage.

No liability can be accepted for any loss or damage arising from incorrect use of products or poor workmanship, over which BAL has no control. *Contact BAL Marketing Department for full details.*

CONDITIONS OF SALE

Sold subject to the Company's Conditions of Sale. *Available on request. For sales and technical queries, contact:*

BUILDING ADHESIVES LTD

Longton Road, Trentham, Stoke-on-Trent, ST4 8JB,

England www.bal-adhesives.com

Sales Tel: +44 (0) 1782 591160

Fax: +44 (0) 1782 591131

Technical Tel: +44 (0) 1782 591120 or +44 (0) 845 600 1 222

Fax: +44 (0) 1782 591121

Unit 622, Phase III

Northwest Business Park

Ballycoolin, Dublin 15, Ireland

Tel: +353 (0) 1 880 9210

Fax: +353 (0) 1 880 9211

NOTE: BAL reserves the right to update instructions, technical data and other information at any time without notice.