

Wetroom Innovations

Uniclass L22231	EPIC B83
C1/SfB	
942	X

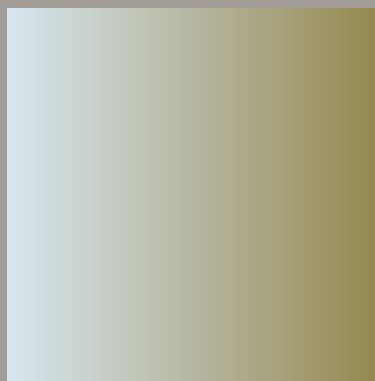

A luxury wetroom
from a simple kit

Finest quality, biggest range, best service and pricing

THE HOME OF 'WETROOM IN A BOX'

You can find all you need to know about installing wetrooms using kits from Wetroom Innovations on the following pages...



Tiled wetfloor



Raised wetfloor



Vinyl wetfloor

■ **WET-DECK FLOOR FORMERS** Page 3

The one-piece trays, Underlay and Maxxus give an even gradient to the drainage point. This guarantees consistent water-flow, ensuring peace of mind when showering.

■ **DRAINAGE** Page 5

All drains have the option of a stainless steel grid or a tile insert top and are quickly accessible, making cleaning and maintenance very simple. When gravity drainage is not an option there is a pumped system available.

■ **SIMPLE KITS** Pages 6 – 8

Simply the biggest choice on the market.

■ **WATERPROOFING** Page 9

The option of BSA self-adhesive membrane or Granfix tanking kit.

■ **BETA SCREENS** Page 13

Our own brand, the most minimal screen on the planet! Made in England in 6mm, 8mm or 10mm thicknesses. Made to measure at stock prices. Stock widths 150mm to 1400mm.

■ **MAXXUS LINEAR SHOWER DECK** Page 11

■ **UNDERFLOOR HEATING** Page 16

The perfect solution for a warm tiled floor; it also dries the tiles faster.

■ **ULTIMATE TILE BACKER BOARD** Page 16

Fully waterproof for floors and walls; general construction board; insulant for underfloor heating (UFH).

WET-DECK FLOOR FORMERS

3rd generation wet deck

MAXXUS wetfloor former is designed to facilitate level-access showering in timber or concrete. It relieves floor space permitting greater access, mobility, freedom and a lighter, more open and contemporary ambience.

For the unique Purus Minimax patented drain - the world's shallowest drain incorporating a trap, the unique NOOD no-odour trap without a water seal.

THE STRONG ONE

MAXXUS has been tested under static load at 1000mm centres. Super-strong MAXXUS, made from vacuum formed GRP, will comfortably support a sustained load of 75 stone (470kilo) load over 16" (400mm) joist centres without deflection.

- Needs no under-boarding.
- Fast 1 hour installation.

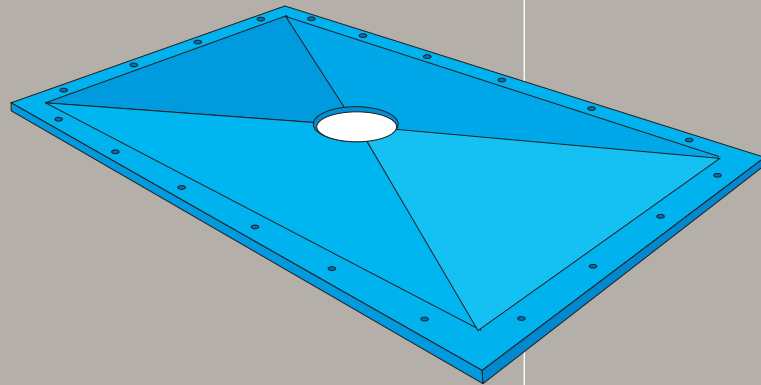
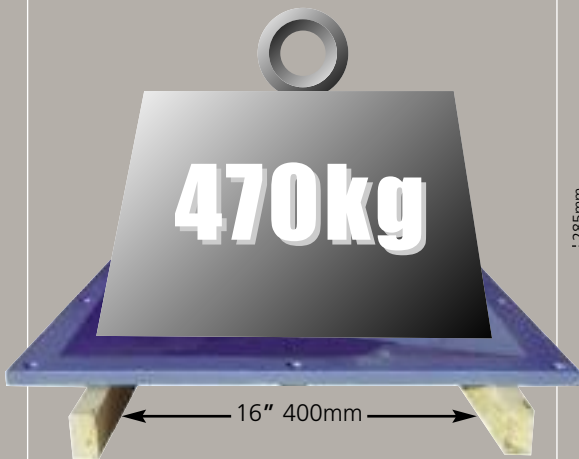

MT934
900mm x 900mm

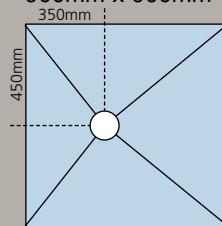

MT930
1000mm x 1000mm

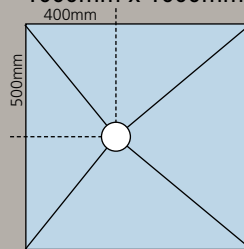

MT931
1135mm x 770mm

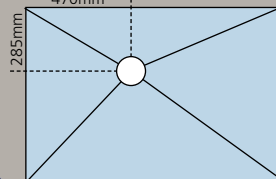

MT932
1300mm x 800mm

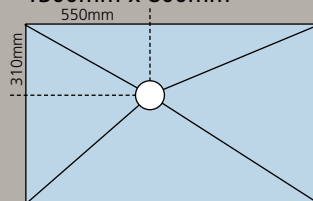

MT1808
1800mm x 800mm

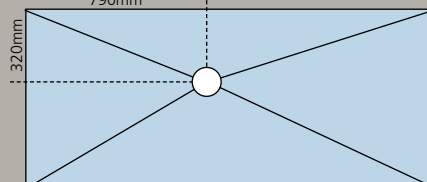

MT933
1500mm x 800mm

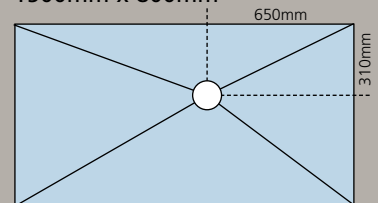

MT935
1400mm x 900mm

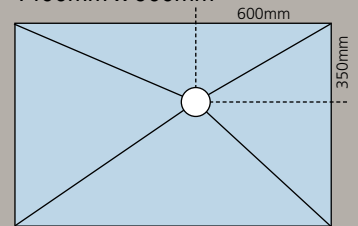

MT936
1200mm x 1200mm

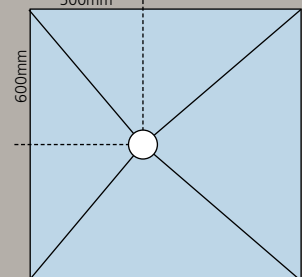

MT1411
1450mm x 1150mm

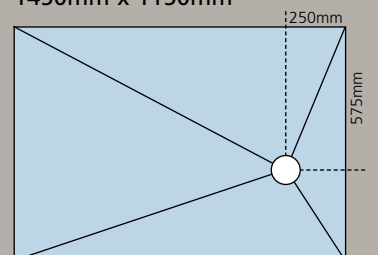

When value matters

MAXXUS

MAXXUS

BENEFITS:

- Simply rotate to place the drain hole in the ideal position.
- May be trimmed down to any size.
- Totally flat underside for easy fixing.
- Recessed screw holes allow easy fixing.
- No release agent to inhibit bonding of adhesives, tanking or membranes.
- Level-access floor, no step.
- **25 year guarantee.**
- **PURUS drains are BBA approved.**

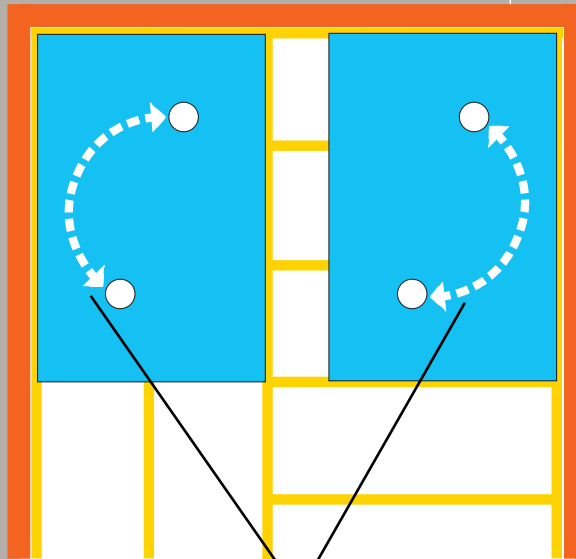

Typical application of MAXXUS over a joist floor (MAXXUS can be rotated to avoid the joists)

Optional drain location - rotate MAXXUS to avoid joists

MAXXUS and MINIMAX ... a winning combination

New to the UK after 2 years development, resolving the issues of high quality and best value for money.

VINYL or **TILED** finish with the same Minimax drain.

- Square stainless steel grating can be supplied for tiling.
- Circular grate for vinyl can be upgraded to stainless steel.



Stainless steel square grating - Drop



Stainless steel square grating - Tile Insert



Stainless steel square grating - Art Deco

- Flows 48 litres per minute.
- Projection beneath tray only 76mm.
- BBA approved.
- Pipe reducer to 40mm incl.



Designer grids to suit MAXXUS or Underlay. 138mm x 138mm x 5mm

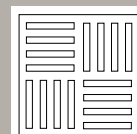

Oblo

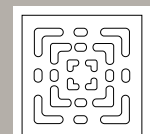

Elle

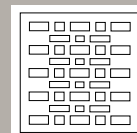

Deco



Circ

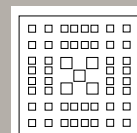

Equa



Array

DRAINAGE

MINI ODEN 50

Conventional water-seal drain flows 40 litres per minute. Pipe reducer to 40mm incl.



MINI BRAGE 50

Vertical outlet drain flows 40 litres per minute. Pipe reducer to 40mm incl.



MINI BRAGE 110

Vertical drain connects to soil pipe.



MINIMAX one part

Depth 70mm. May be pumped.



Note: All the above are suitable for tiled (with addition of square grid and frame – see page 4) or vinyl floors with round plastic grate included.

Minimax 2-part



Tile Insert or invert for Steel



Platinum top



When value matters

SIMPLE WETROOM KITS – fast 1 hour install

MAXXUS

For tiling and Vinyl

KITS USING:

- ML – GRANFIX TANKING KIT**
- MB – BSA™ SHEET MEMBRANE**

Wetroom-in-a-box

- 3rd Generation Deck.
- Rigid, structural over joists - no under boarding needed.
- Maxxus is 22mm thick.
- Maxxus has a 50mm flat perimeter border.
- Drain flow is 47 litres per minute.

Kit contents:

- 1 - Maxxus for level access.
- 1 - Minimax drain c/w stainless grid. Horizontal or Vertical outlet (please specify).
- 1 - Pipe reducer 2" to 1½" (50mm to 40mm).

Plus either:

- 1 - 8k tanking liquid Granfix (covers 10m²).
- 1 - 1 litre Primer for porous surfaces.
- 1 - 10m Tape for wall/floor joint and other gaps.
- 2 - Internal corners.
- 2 - Pipe collars.
- 1 - 75mm or 100mm brush.

or

- 1 - BSA Self-adhesive Membrane 1000mm wide.
- 1 - 10 metre joint tape.
- 1 - Adhesive sealant cartridge.
- 2 - Internal corner pieces.
- 1 - 1 litre Primer.
- 1 - Roller to ensure adhesion of membrane.

Note: If supplied for vinyl flooring a stainless steel grid and tanking kit is not required.

6 Designer grid options available. Will take the optional drains Mini Brage and Mini Oden (see page 5).

ML934 / MB934

900mm x 900mm

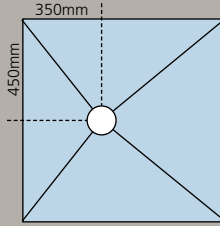

ML930 / MB930

1000mm x 1000mm

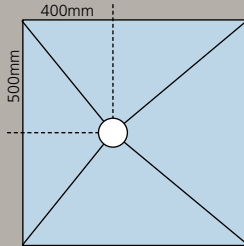

ML931 / MB931

1135mm x 770mm

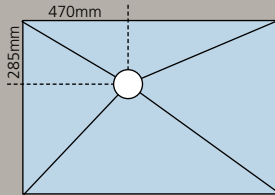

ML932 / MB932

1300mm x 800mm

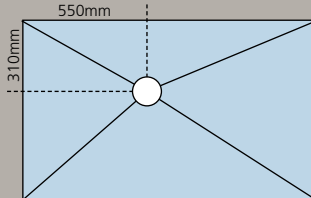

ML933 / MB933

1500mm x 800mm

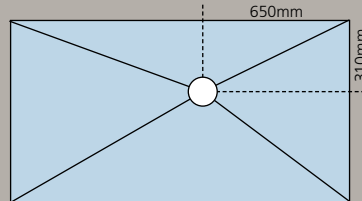

ML935 / MB935

1400mm x 900mm

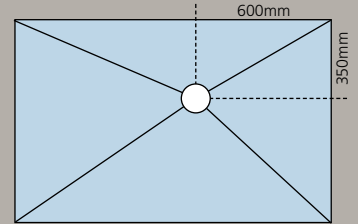

ML936 / MB936

1200mm x 1200mm

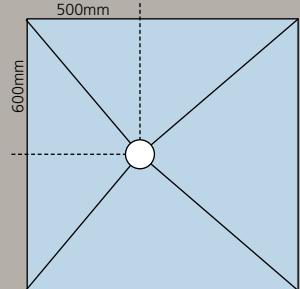

ML1411 / MB1411

1450mm x 1150mm

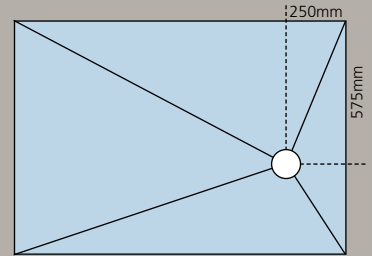

ML1808 / MB1808

1800mm x 820mm

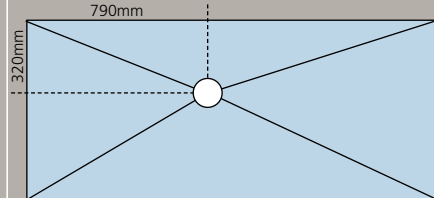

PLASTIC PLY

1.2m² pack
(4 sheets 600mm x 500mm)
Thickness 2mm mesh

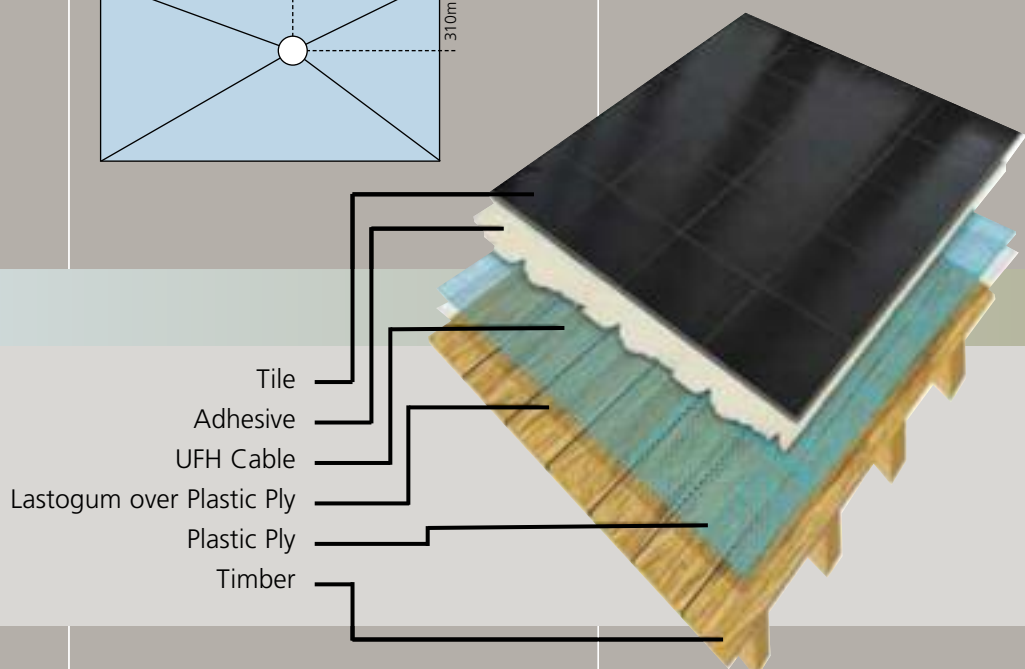

SIMPLE WETROOM KITS – Marmox

Marmox Underlay Selection

Suits concrete and timber joist floors (needs under-boarding). For tiling only (minimum size 25mm x 25mm).

- Fully waterproof.
- Lightweight to handle.
- Ready for tiling.
- Centre or offset drainage.
- Can be cut to size.



Centre drain

Size (mm)	Thickness	Weight
800 x 800	20mm	3.5kg
900 x 900	20mm	4.2kg
1000 x 1000	20mm	5.0kg
1200 x 900	20mm	5.2kg
1200 x 1200	20mm	7.0kg
1500 x 1500	24mm	10.5kg

Offset drain

Size (mm)	Thickness	Weight
1000 x 1000	20mm	5.0kg
1300 x 800	20mm	5.2kg
1500 x 800	24mm	6.0kg
1200 x 900	20mm	5.2kg
1200 x 1200	20mm	7.0kg
1850 x 900	24mm	8.5kg

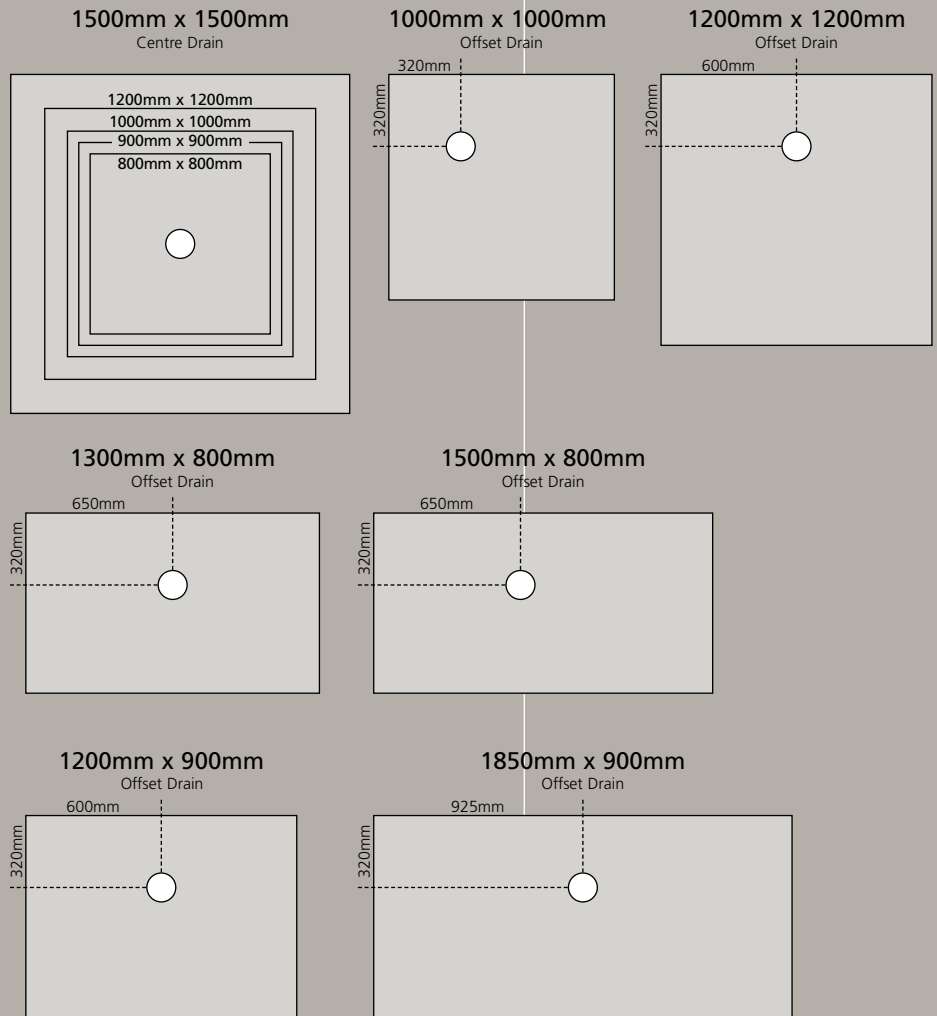

CUSTOM-MADE SERVICE

Wet decks made to any size, drain hole located anywhere.
(underlay product only)

PLASTIC PLY

- Decouples tiling from timber substrate, helping to prevent tile-cracking.
- Levels off a floor where Maxxus deck(22mm thick) abuts 18mm boards or plywood.
- Eliminates over-boarding with plywood.
- Suitable for smooth concrete or timber.

A revolutionary solution for fixing tiles to timber or plywood floors. Prevents problems of tile damage by reducing the effects of timber shrinkage, warping and rotting. Easy to cut and install with a self-adhesive backing.

When value matters

SIMPLE WETROOM KITS – PCS

PCS Underlay Selection

Suits concrete or timber joist floors (needs under-boarding). For tiling only (minimum size 25mm x 25mm).

1000mm x 1000mm x 20mm

Offset Drain

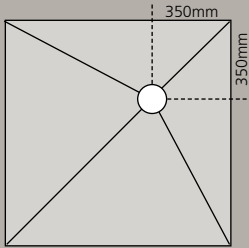

1200mm x 800mm x 20mm

Offset Drain

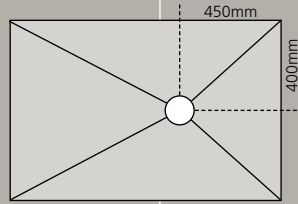

1200mm x 800mm x 20mm

Centre Drain

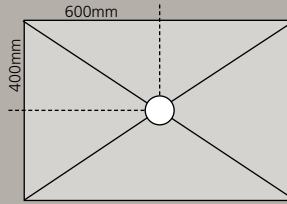

1500mm x 1500mm x 20mm

Centre Drain

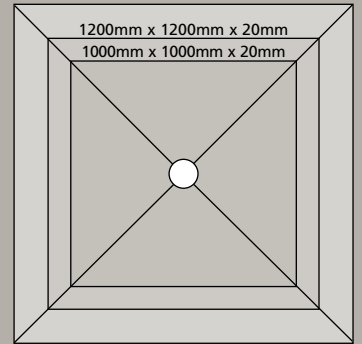

1200mm x 900mm x 20mm

Centre Drain

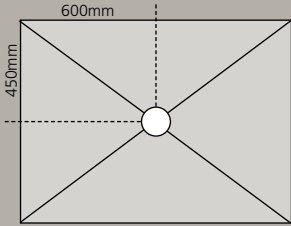

1200mm x 900mm x 20mm

Offset Drain

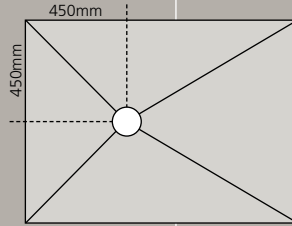

1200mm x 1000mm x 20mm

Offset Drain

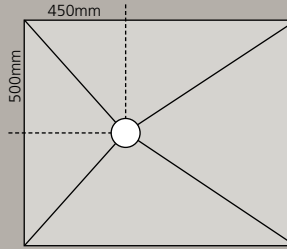

1200mm x 1200mm x 20mm

Offset Drain

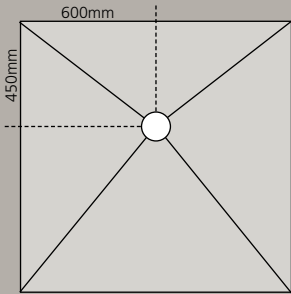

1500mm x 1050mm x 25mm

Offset Drain

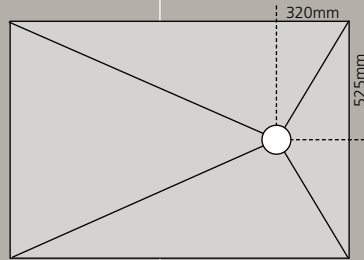

1500mm x 800mm x 25mm

Offset Drain

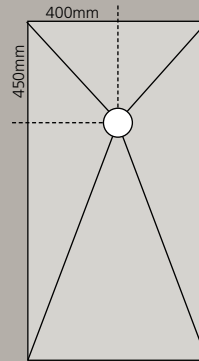

1800mm x 800mm x 25mm

Offset Drain

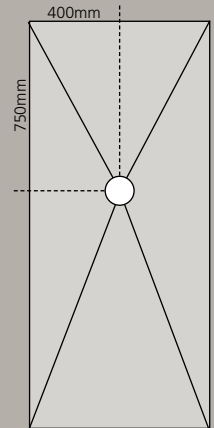

1650mm x 900mm x 25mm

Centre Drain

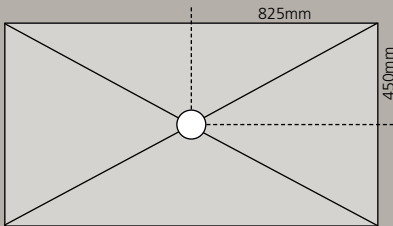

1950mm x 950mm x 30mm

Offset Drain

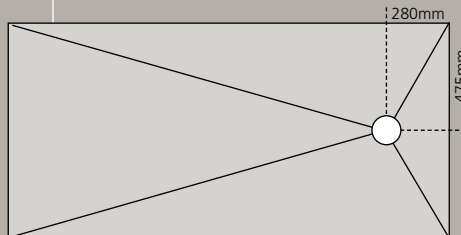

CUSTOM-MADE SERVICE

Wet decks made to any size, drain hole located anywhere. (underlay product only)

WATERPROOFING

GRANFIX – TANKING SYSTEMS FOR WETROOMS AND BATHROOMS

- Used to provide a flexible water-proof membrane (tanking) before tiling over with a flexible bag-powder (cementitious) tile adhesive.
- A 2-coat application will protect even when cracks up to 1mm open in the substrate.
- Will cover any substrate, but use primer over timber, plasterboard or any porous surface.
- Non-toxic, clean brushes in water.
- Can be trowelled, but will cover 10m² by brush or roller.



Granfix Kit contents:

- 1 - 1 Bucket 8k
- 1 - 1 litre Primer
- 1 - 10m tape
- 2 - Internal corners
- 2 - Pipe collars
- 1 - 1 Brush 75mm

INSTALLATION METHOD

- 1 Prime the substrate if porous. Primer is water-based and can be thinned to produce 2 litres. Allow to dry.
- 2 Apply first coat of Granfix in one direction only. Start high in the corner of the wall, bedding a 1.7m length of tape into the first coat. Complete the wall area.

Apply pre-formed corner in place, then more tape into wall/floor joint, overbrushing as you go. Use pipe collars for copper shower-supply pipes. Allow to dry overnight or may be overbrushed after 3 hours.

- 3 Apply second coat Granfix in the opposite direction (ie: at 90 degrees). Dries clear.

Note: Fully compatible with all electric underfloor heating systems laid over the tanking membrane.

BSA™ SELF-ADHESIVE BITUMEN MEMBRANE

For the tanking of internal wetroom walls and floors.

- Retains water within the 'wet area', preventing leakage to rooms below.
- Suitable for homes, hotels, flats, sports facilities, changing rooms, hospitals.
- Remains flexible, allowing for movement in the building structure.

Comprising of a 2mm thick self-adhesive, cold-applied membrane with unique adhesive band on front face (90mm wide) to promote secure adhesion. Perfect for stone, brick, timber, concrete, plasterboard, and existing tiling (if securely fixed). No drying period, can be tiled immediately using bag-powder, flexible tile adhesive.

- Use in bathrooms, shower areas, wetrooms, balconies, kitchens.
- Maximum tile/adhesive/grout load combined 20 kg/m² = 10mm tile thickness.
- Geo-textile surface for improved tile adhesive bond.
- No putty needed - flexible adhesive applied for gap-filling.
- Roller applied to bed the BSA.
- Suits any electric UFH system.
- Kits of 10m² or 5m², 1000mm wide.

BSA Kit Contents:

- 1 - Roll membrane.
- 1 - 10 metre joint tape.
- 1 - 1 litre Primer.
- 1 - Adhesive sealant cartridge.
- 2 - Internal corners.
- 1 - Roller.

INSTALLATION METHOD

Firstly, apply tape to wall/floor joint, corners and places where membrane edges meet. The membrane is applied to floor, followed by sealing the joints with a skeleton gun. It may be preferred to apply to floors only, dressing up walls by 100mm only, then tanking the walls with the tanking kit. This overcomes the tile loading limitation.



When value matters

LIVING LINEAR WET TRAY



LIVING LINEAR WET TRAY & PURUS CHANNEL DRAIN

For cutting-edge performance, efficiency and style. Enjoy a contemporary on-trend wetroom aesthetic.

- Suits timber or concrete floors.
- Level access (no step) tiled finish for mosaic or large format tiling.
- 30 tons per sq metre density load bearing.
- 30lit/min or 60lit/min fast-flow drain gully.
- Grating choice of Twist, Drop or Tile Insert.
- 22mm thickness.
- DIY or professional installation.
- Very simple tanking kit covers 10m².

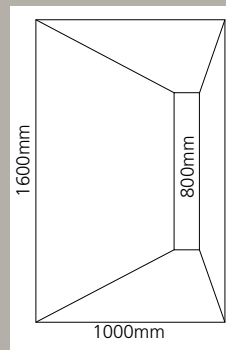
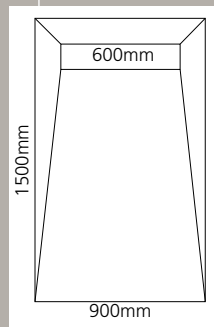
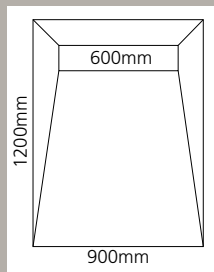
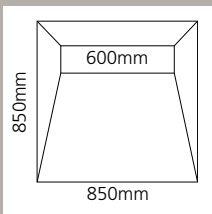

PURUS CENTRE LINEAR



CENTRE LINEAR FLOOR FORMER & PURUS CHANNEL DRAIN

For cutting-edge performance, efficiency and style. Enjoy a contemporary on-trend wetroom aesthetic.

- Suits timber or concrete floors.
- Level access (no step).
- Mosaic or large-format tiling.
- 30lit/min or 60lit/min fast-flow drain gully.
- Grating choice of Twist, Drop or Tile Insert.
- 18mm thickness.
- Very simple tanking kit covers 10m².

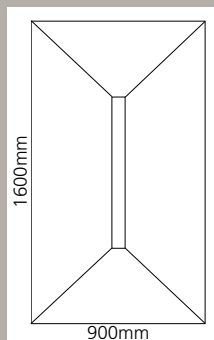
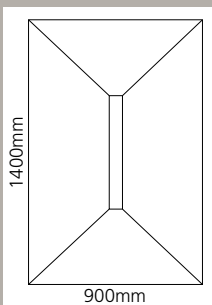

MAXXUS LINEAR SHOWER DECK

MAXXUS

The unique Channel Deck incorporates the 800mm Purus Line channel drain and the patented NOOD* (no odour) trap.

- For tile only.
- Can be reduced in size.
- 1 hour installation.
- 22mm thickness.
- 7 gratings available, plus unique tile insert version.
- Height-adjustable to suit tiling level via integral raising screws.
- Pipe outlet options: 40mm (via reducer) 50mm and 75mm diameters. Vertical or horizontal outlets available.
- **BBA approved drains.**

* NOOD is a patented ultra-high flow drain that prevents back-flow and eliminates smells should a water seal trap evaporate.

- There is no flat perimeter border. Needs no support legs as drain clamps into deck aperture.

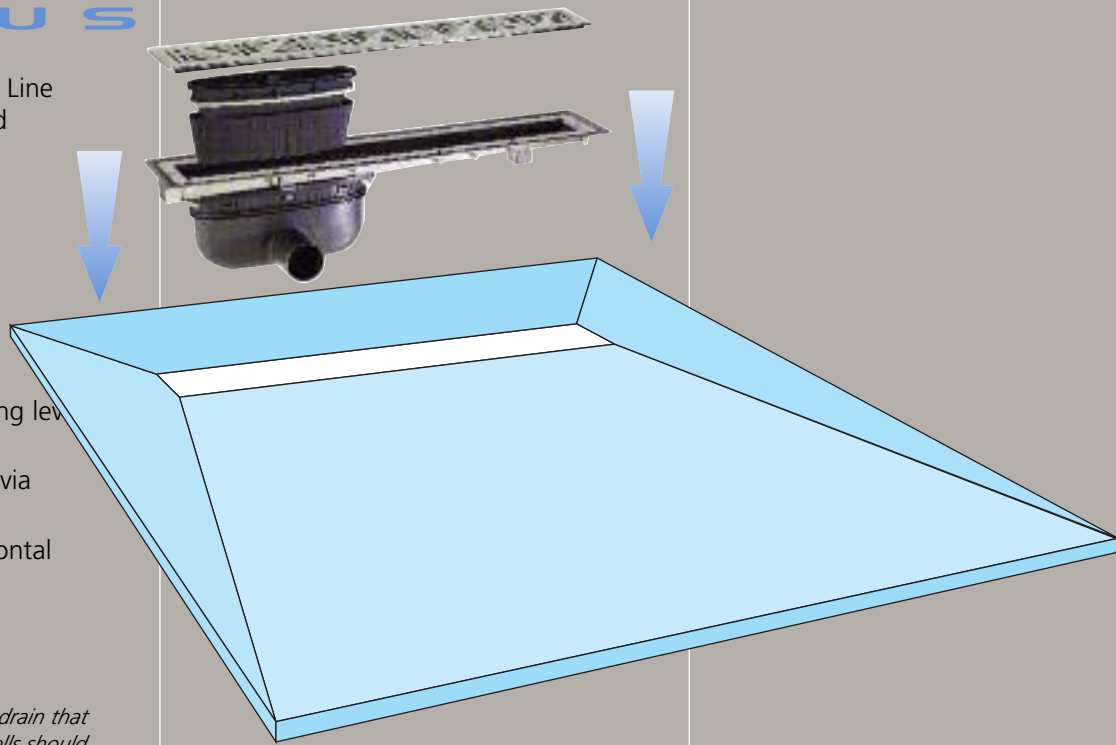

6821937

1200mm x 900mm

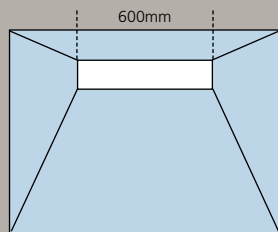

6821938

1200mm x 1200mm

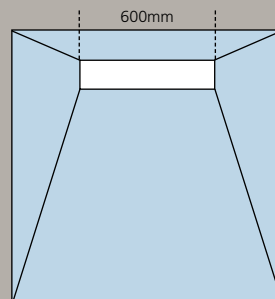

6821985

1400mm x 900mm

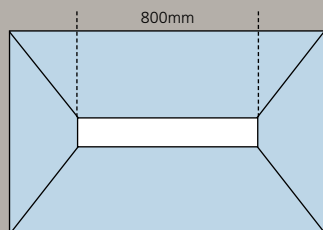

6821986

1600mm x 900mm

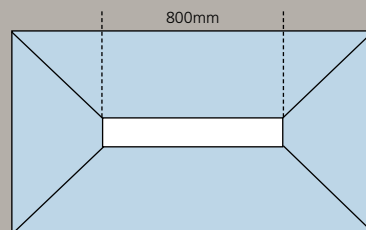

BETA SCREENS AND DOORS

Frameless for trays or wetfloors

Pioneers of the pared-back wetroom aesthetic, BETA is the most minimal screen on the planet. All British* Lifetime warranty. 6mm, 8mm or 10mm thick. 2000mm high or specials at no extra cost.

- **Wall Fixing** - Super slim edge channel (with gasket) or 3 edge clamps.
- **Top Brace** - Slim 8mm rod 1200mm long or bent 800mm long.
- **Toe Pedestal** - Unique, adjustable, gaps of 5mm, 17mm, 65mm or 130mm.

Optional short ceiling fixing or 44mm diameter floor to ceiling pole.

See BETA brochure for full details of BETA options. Specials at no extra cost.

*All British means glass and 85% of hardware.

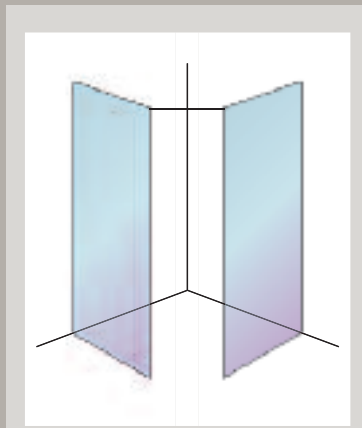
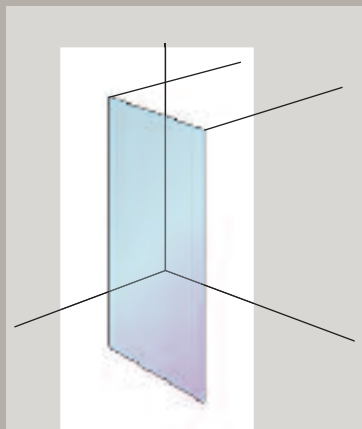
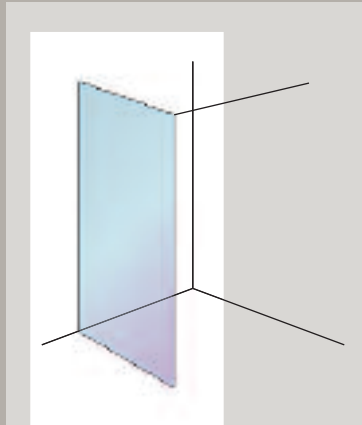

Standard Screen

Widths available:

- | | |
|--------|--------|
| 150mm | 200mm |
| 300mm | 400mm |
| 500mm | 600mm |
| 700mm | 800mm |
| 900mm | 1000mm |
| 1100mm | 1200mm |
| 1400mm | |

Dual Entry Screen

Widths available:

- 900mm
- 1000mm
- 1100mm
- 1200mm
- 1400mm

Corner Entry Screen

Any width from 200mm to 1500mm

Door

Choice of knob, dual towel rail handle or finger hole pull.

Widths available:

- 700mm
- 750mm
- 800mm

Special sizes at no extra cost.

GLO-SCREENS

We manufacture all-British frameless minimalist shower screens. All screens are illuminated by a glo-strip along the wall edge in thicknesses of 6mm, 8mm or 10mm. Available in clear or satinised (obscure) glass; widths 150mm – 1400mm (in 100mm increments) x 2000mm height. Bespoke options at no extra cost.



Glo-screen Pattern A3 to special order



Glo-screen white



Glo-screen red



Glo-screen green



Glo-screen blue

FELICI BY BETA



Flipper Walk-In Panels

8mm clear glass.
For trays or tiled wetfloors.
Comprises fixed screen with 180° hinged flipper panel.

Sizes:

700mm x 2000mm

with 330mm flipper panel

900mm x 2000mm

with 330mm flipper panel

Hardware included:
Wall edge channel, top brace, hinges, 500mm towel rail, bottom seal 330mm long, joint flap seal.

Note: There is a hinge gap of 6mm between the two panels.

When value matters

LINKE LINE LINEAR CHANNEL DRAINS

All – stainless made in Britain with Purus NOOD gulley.
Heavyweight unit (700mm, weight 2.5k) BS EN1253

Product Technical Data Information

Lengths: 500mm, 700mm, 950mm,
 1050mm, 1300mm.

- All stainless steel body and grating top.
- Top access removable NOOD trap restricts odours and back-flow, even in the event of a dry trap.
- Adjustable grating height – 10mm tile up to 17mm max.
- 50mm outlet with 40mm solvent weld reducer.
- Profile depth of metal body = 25mm.
- Applications: bathrooms, shower spaces, wetrooms.
- Suitability: tiling only.
- **BBA approved gulley.**





Linke Line Steel Top

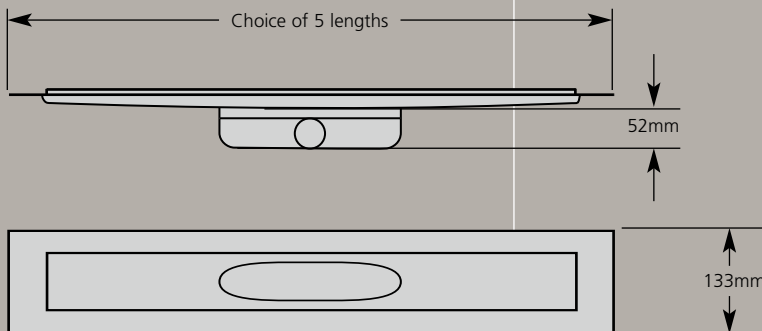

Linke Line Tile Insert

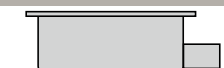

NOOD (no odour) Gulley Options

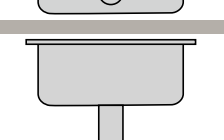
-  Low (52mm side outlet)
-  105mm (end parallel outlet)
-  105mm (side outlet)
-  105mm (vertical outlet)



Support Legs (concrete)

All 50mm outlets come with 40mm solvent-weld reducer

Purus outlet/gulley

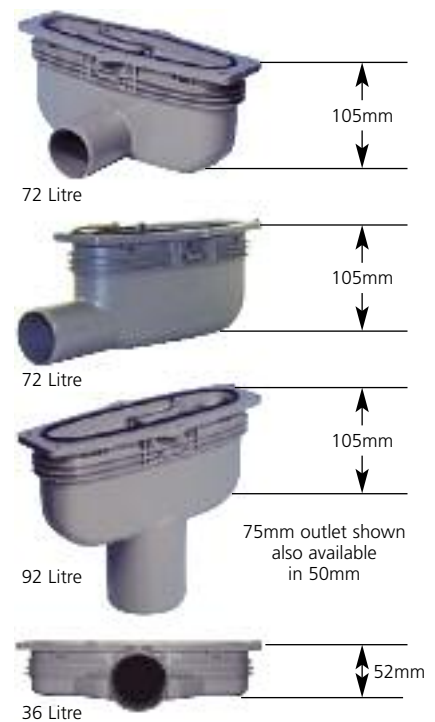

UNDERFLOOR HEATING (UFH)



UFH mat and thermostat



Our underfloor heating comprises a 500mm wide mat system with self-adhesive backing. Rated 160W/m², 3.5mm thick and perfect for use as full regular room heating. For timber and concrete sub-floors, usually installed beneath tiling. Twin conductor elements give very low electromagnetic fields and require connection at one end only. To ensure electrical safety the cable is earthed using a metallic screen and may be laid directly in the wet area for luxurious showering and an aid to dry tiling afterwards.

Includes floor sensor and digital thermostat with 7-day, 24-hour timer with up to four on/off settings per day.

Kits 1m² up to 21m². Manufactured to ISO9001 standard; 10 year warranty. Maximum performance is achieved with floor insulation to prevent heat migrating downwards – see tile backer board below. By using TBB a warm floor can be achieved in as little as 20 minutes compared to several hours without their use.

ULTIMATE TILE BACKER BOARD (TBB)



TBB is an insulated backer board fully waterproof for walls and floors, unlike heavy cement-based moisture-resistant boards. 4mm to 60mm thickness. Has the correct hard surface that cannot be pierced with a finger nail. Insulated core for improved U-value. Minimises tile cracking when substrate moves or shrinks owing to stability engendered by glass fibre re-inforcement mesh. The perfect wetroom lining and tanking board – offers instant membrane when joints are sealed.

Install beneath UFH to prevent heat-loss below the floor. You can also use Tile Backer Board as a general construction board to build vanity units and partitions for tiling. Also available: special bath infill panels, boxing for soil pipes, curved boards, fixing washers and dowels.

Density: 30tons per sq. metre

Thickness (mm)	Width (mm)	Length (mm)	Weight (kg)	R value (m.k/w)
4	600	1200	2.3	0.10
6	600	1200	2.4	0.16
10	600	1200/2400	2.7/5.4	0.28
12.5	600	1200/2400	2.8/5.6	0.36
20	600	2400	3.1/6.2	0.59
30	600	2400	3.4/6.8	0.91
40	600	2400	4.0/8.0	1.22
50	600	2400	4.2/8.4	1.53
60	600	2400	4.5/9.0	1.84

MR. STEAM GENERATORS



Build a home steamroom

Take home bathing to a new level of luxury, sophistication and satisfaction with a home spa/steamroom. Enjoy steam bathing in a compact shower enclosure as part of a wetroom.

Enjoy the benefits of steam

The warmth opens the skin pores leaving it soft and supple, engendering a sense of cleanliness, wellness and fitness. The perspiration aids removal of impurities; the steam aids the relief of tired muscles.

Features

- Compact, easy to install with fast snap-in connectors
- Self-diagnostic LED indicators
- Electronic water-level control
- CE certified
- Lifetime limited warranty

Note: For best results and fast warm-up, line all walls and ceiling with insulated tile backer board (TBB) – see page 15.

Including thermostatic controller.



Max room volume m ³	Kilowatt	Code
2.83	5.0	M9
4.25	6.0	M15
6.37	7.5	M22
10.20	9.0	M40
13.40	10	M1E
16.20	12	M2E
19.10	15	M3E
24.70	20	M4E
30.40	25	M5E
36.10	30	M6E