

## MADE-TO-MEASURE STAINLESS STEEL



GEC Anderson worktops are MADE-TO-MEASURE in one continuous piece, to the exact shape and size prescribed and with NO JOINS at sink bowl(s), edges or upstands. Worktops are flat (not sloping or fluted) with 18 mm bonded substrate, for strength, rigidity and ease of fixing. Installation is simple and rapid with no further work on site required.

With timber base cabinets, simply screw-fix to bonded substrate from below.

Alternatively, specify stainless steel **Legs** (see page 6). Alternatively, use stainless steel **Cantilever Brackets** (see page 6).

Alternatively, use GEC Anderson stainless steel **Base Cabinets** (see page 7).

- **Sink bowls** are positioned where required, in any combination or arrangement
- **Cut-outs** (eg. for tapholes, hobs, columns etc.) as required
- **Edge details** are specified by you depending on individual end-user needs and requirements
- **Maximum length:** 5 metres.  
*Maximum return for L-shapes and U-shapes:* 2.3 metres
- **Maximum size for textured finish:** 2.4 x 1.15 metres

- Sinks
- Worktops
- Cabinets
- Panels
- Doors
- Shelving

MADE-TO-MEASURE stainless steel sinks, worktops, cabinets, panels, doors and shelving are produced to meet your precise requirements and dimensions using GEC Anderson brushed satin finish stainless steel (EN 1.4301).

### Options

*Textured finish stainless steel and EN 1.4401 acid-resisting grade stainless steel.*

### Product Specification Data

Please read in conjunction with GEC Anderson brochure: *Sinks, Worktops, Cabinets, Shelving & Sanitaryware*

**SINGLE BOWLS**

**SINK BOWLS**

Sink bowls are fully integrated with worksurface – exactly where required and in any position or combination – with no joins. Special sizes are also available. Sink bowls can be supplied individually (eg. to inset or undermount).

When selecting sink bowls and combination units, please note:

■ **Minimum distances/ spaces required:**

- From any edge to bowl: 35mm (70mm when mounted on stainless steel legs)
- Between two or more single bowls integrated into same worktop: 35mm
- For tapholes: 80mm

■ **Manufacturing tolerances:**

- +/- 2mm
- **Bowl sizes:** provided as internal measurements excluding flange. Non-standard sizes available to order

■ **Depth:** Measured at deepest point by outlet. Bowls slope approx. 20mm towards outlet

■ **Outlets:**

- Standard:** Ø89mm with basket strainer waste (BSW) and overflow (except for SD52, T10, LE70 and V211: Ø38mm)

**Option**

- Ø38mm plug-waste and overflow

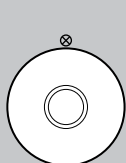

**LR31** (Ø313 x 150) **30**

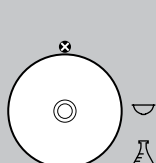

**V211** (Ø300 x 130) **20**

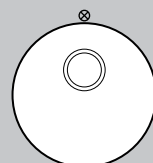

**LR38** (Ø380 x 160) **30**

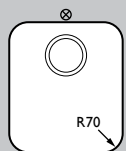

**LE30+** (300 x 344 x 175)

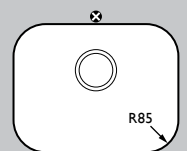

**LE43+** (436 x 339 x 160)

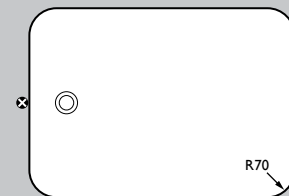

**LE70+** (700 x 500 x 300) **30**



**LE34+** (340 x 400 x 160) **20**

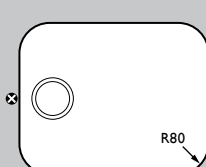

**LE50+** (500 x 400 x 200) **30**

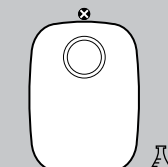

**T29+** (290 x 400 x 165)

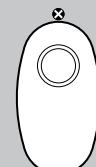

**T22+** (220 x 400 x 170)

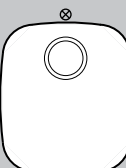

**LE35+** (350 x 400 x 165)

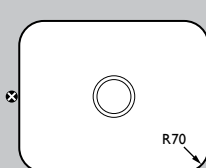

**BE50+** (500 x 400 x 200) **30**

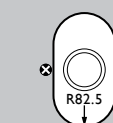

**T16+** (165 x 300 x 130) **20**

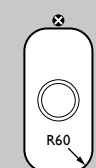

**T18+** (180 x 380 x 160)



**LE42+** (420 x 400 x 180)

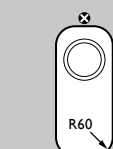

**T15+** (150 x 344 x 120)



**T10+** (100 x 250 x 125) **10**

**KEY**

**10 20 30** Available with either 10, 20, 30mm flat flange for inseting  
NB. 1511 and 1521 have self-rim edge

- ⊗ Overflow position
- ⊗ Optional overflow

+ Available as inset with 50mm bevelled flange

Available in EN 1.4401 acid-resisting grade stainless steel

All dimensions in millimetres

**BOWL FIXINGS AND FLANGES FOR BOWLS SUPPLIED INDIVIDUALLY**

**Above surface**  
**A or C** – including fixing clamps

**Below surface**  
**B** – no fixing clamps

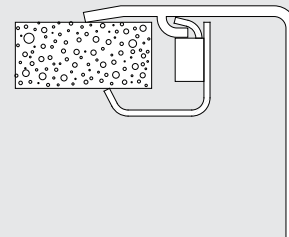
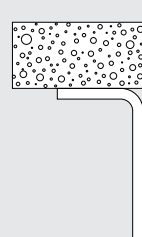
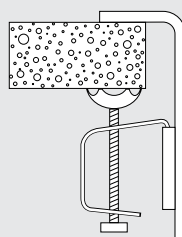

**A** Above

**B** Below

**C** Above (50mm bevelled flange)

**SQUARE BOWLS**

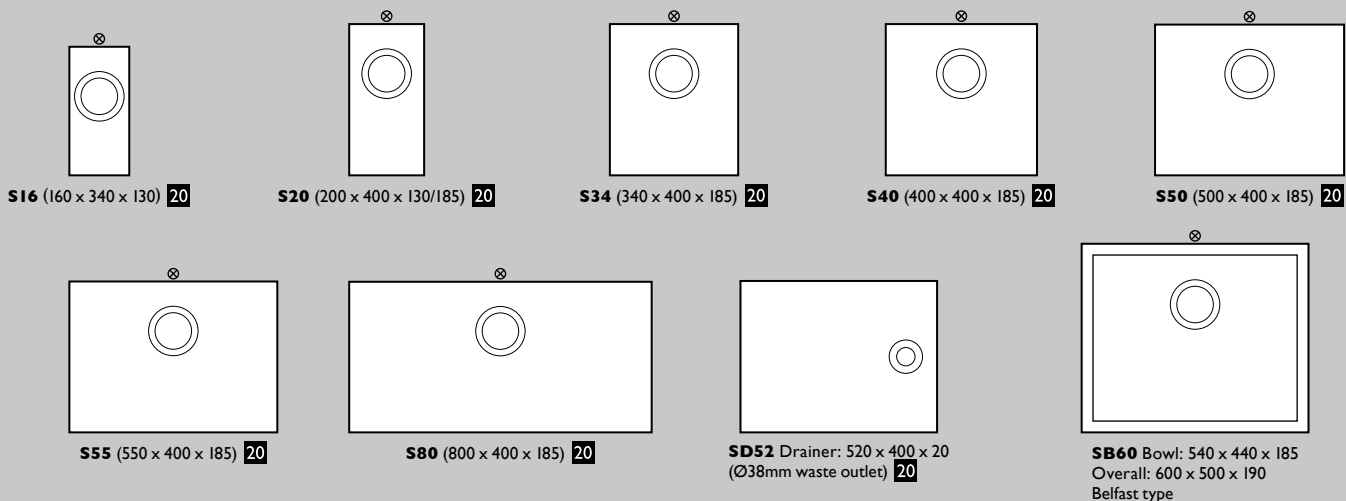

**COMBINATIONS (Slop sink available to left or right of bowl)**

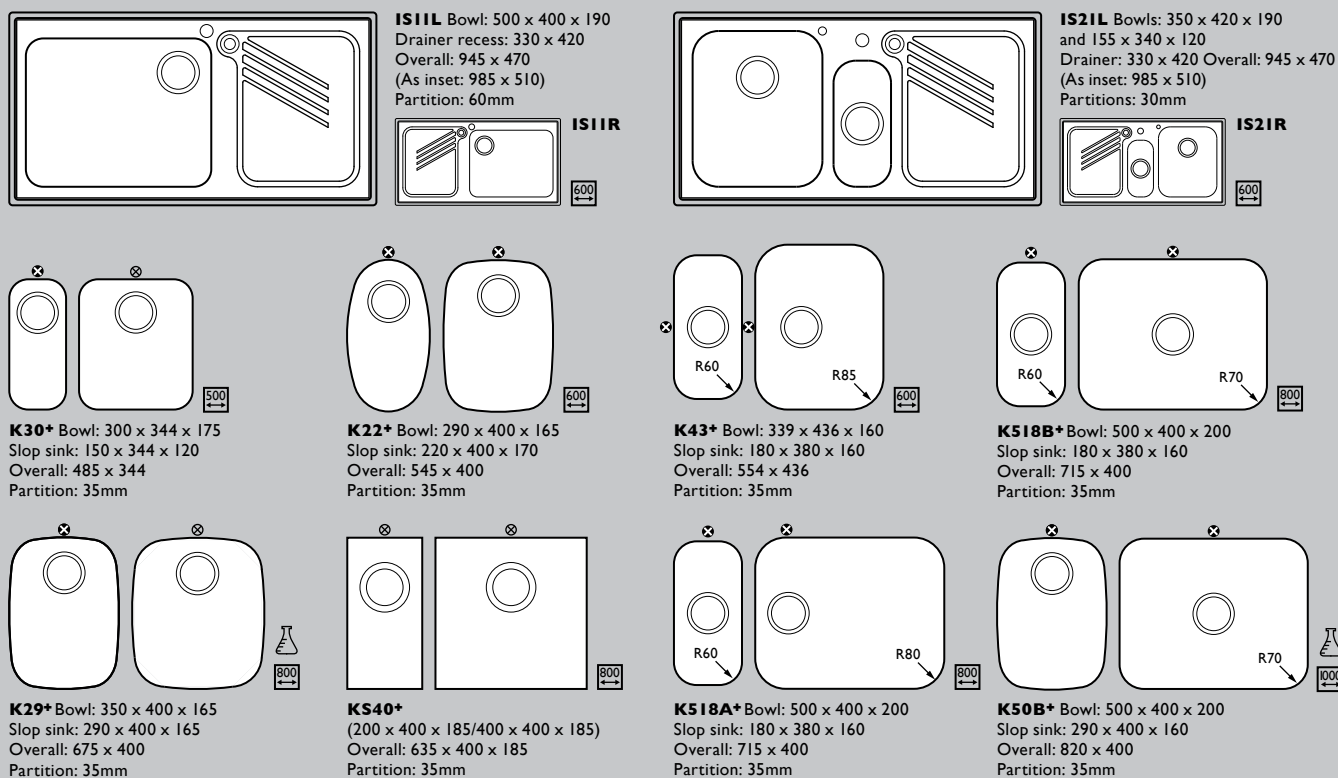

**DOUBLE BOWLS**

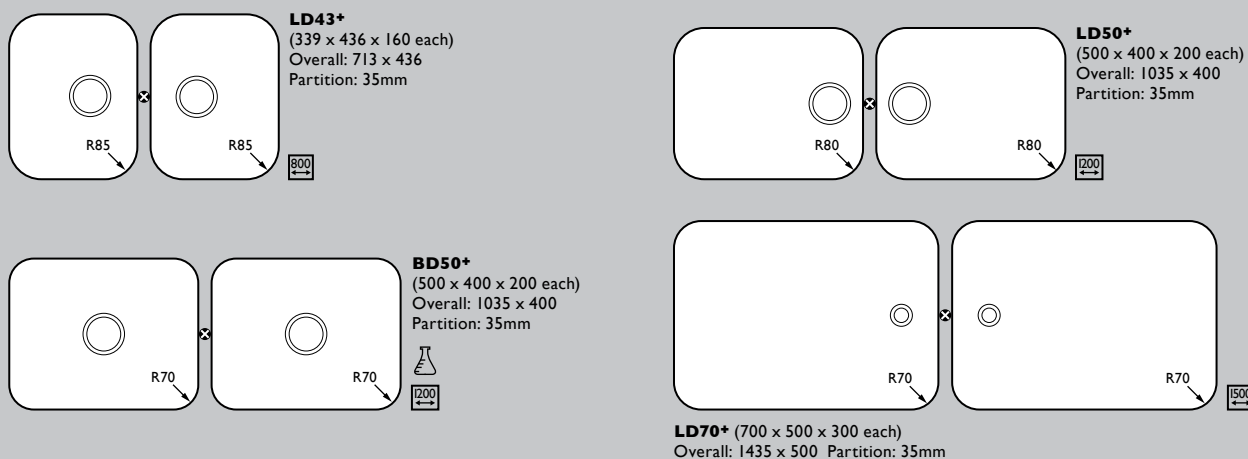

FRONT/SIDE	SIDE/BACK	BACK/SIDE	
<b>3</b> (Standard height 30mm) 	<b>2</b> (Standard height 30mm) 	<b>1</b> 	
<b>5</b> (Standard height 25mm) 	<b>4</b> (Standard height 25mm) 	<b>6D</b> 	
<b>7</b> (Standard height 20mm) 	<b>8</b> (Standard height 20mm) 	<b>6</b> 	

**EDGE DETAILS**

Edge details can be specified by you in various combinations, depending on individual end-user requirements and to ensure correct installation.

- Available as drawn (standard edges) or with varied dimensions (maximum height 100mm)
- 18mm waterproof particle-board core is standard. Increased board thickness available unless precluded by unit size or weight
- With stainless steel legs, add 20mm to standard worktop thickness

Other edges available, see website or contact us for further details.

UPSTAND		
<b>10</b> (30-100mm high) 	<b>10R</b> (30-100mm high) 	
INSET		HTM63
<p>Special edge detail, with watersafe profile, to allow tops to be inset into other work-surface materials. Clamps supplied for fixing.</p>		

### PANELS AND SPLASHBACKS

GEC Anderson stainless steel panels and splashbacks are available in any size or shape and offer a durable, hygienic, easy to clean and attractive alternative eg. to tiles or painted finishes. Stainless steel door and drawer-fronts are also available.

- Folded edges with waterproof particle-board backing are standard. Standard edges 15mm
- Standard sheet sizes up to: 3 x 1.5 and 4 x 1 metres

#### Options

- Folded edge 20mm
- Flat sheet available (backed or un-backed)
- Cut-outs (eg. for electrical points) are available as required



### SHELVING SYSTEM

V90

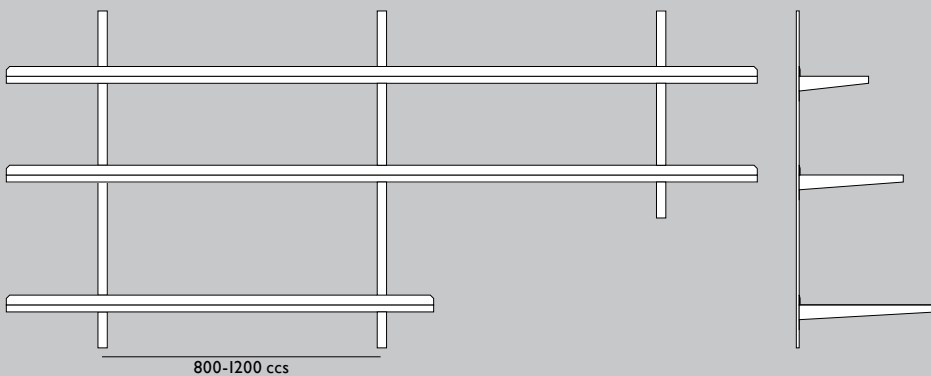

### SHELVING

The unique GEC Anderson V90 shelving is a wall-fixed, 3-part stainless steel system providing versatile, flexible, attractive and hygienic open-storage suitable for many uses and environments. All components (shelves, uprights and brackets) are available individually and can be configured as required. Brackets locate to stepless and continuous (unslotted) uprights with a single clamp-screw. Shelves are solid.

- Maximum shelf length: 3.8 metres
- Standard shelf widths: 200, 300, 400, 500mm
- Uprights: 400, 600, 800, 1000, 1500, 1800, 2000mm. Recommended upright spacing: 800 – 1000mm
- StorTidy modules based on the V90 system are available in standard sets (see GEC Anderson Stainless Steel Sanitaryware)

#### Options

- Perforated shelves
- Barred shelf

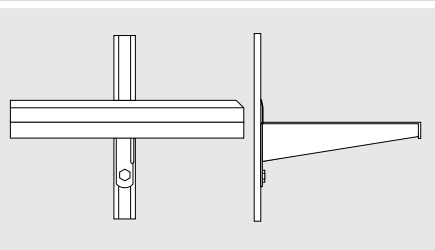

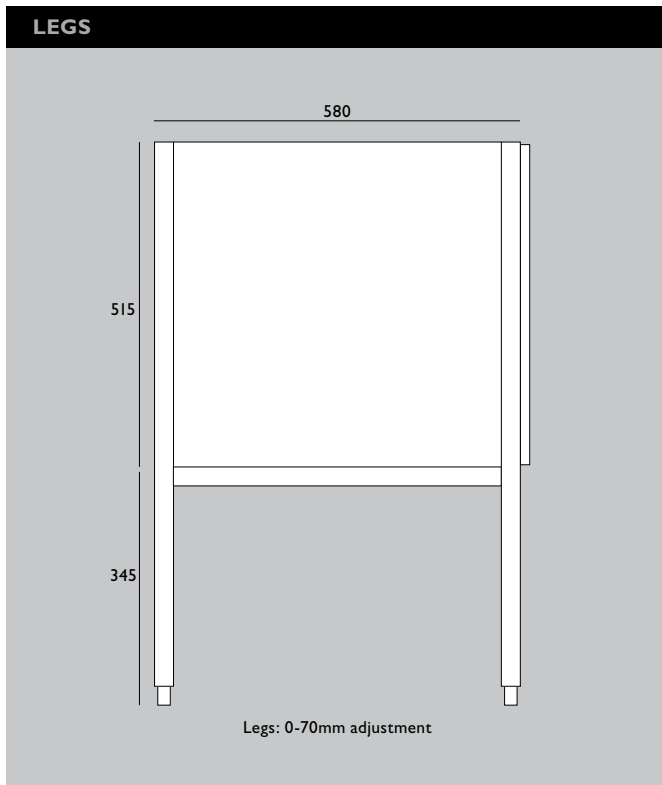

### LEGS

GEC Anderson stainless steel legs provide high weight capacity, durable and practical free-standing stainless steel worktops. They can also be supplied on their own (eg. for other worktop materials).

- 30 x 30mm square-section tubular brushed satin stainless steel legs
- Ø8mm barred shelf with 25 x 25mm perimeter frame
- 0 – 70mm manually adjustable plastic feet

### Options

- Solid shelf
- No shelf
- Multiple shelves
- Chrome-plated feet (eg. for high fire-risk areas)
- Motorised, hydraulic adjustment system (+ - 300mm) for rapid and reliable multi-height units
- Braked castors (zinc-coated steel: Ø125mm rubber tyre. Overall height: 160mm)
- Special fixings (eg. floor-fixing plates) and clearances (eg. for pipework) on request

### CANTILEVER BRACKETS

GEC Anderson stainless steel cantilever brackets provide medium weight capacity wall-mounted support to surfaces. Uninterrupted floor access eg. for cleaning and flexible storage spaces is a clear benefit when compared to free-standing units.

- 30 x 30mm square section tubular brushed satin stainless steel with 20 x 20mm cross brace
- Recommended spacing: 800 – 1000mm

### Option

- Lower shelf prong

### CANTILEVER BRACKETS



### V21

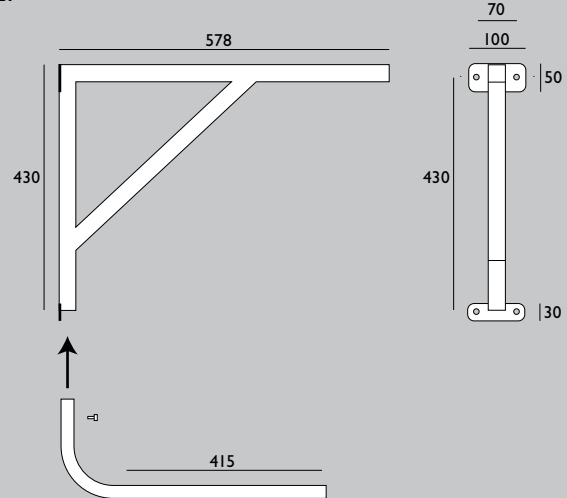

V22 (with optional undershelf support)

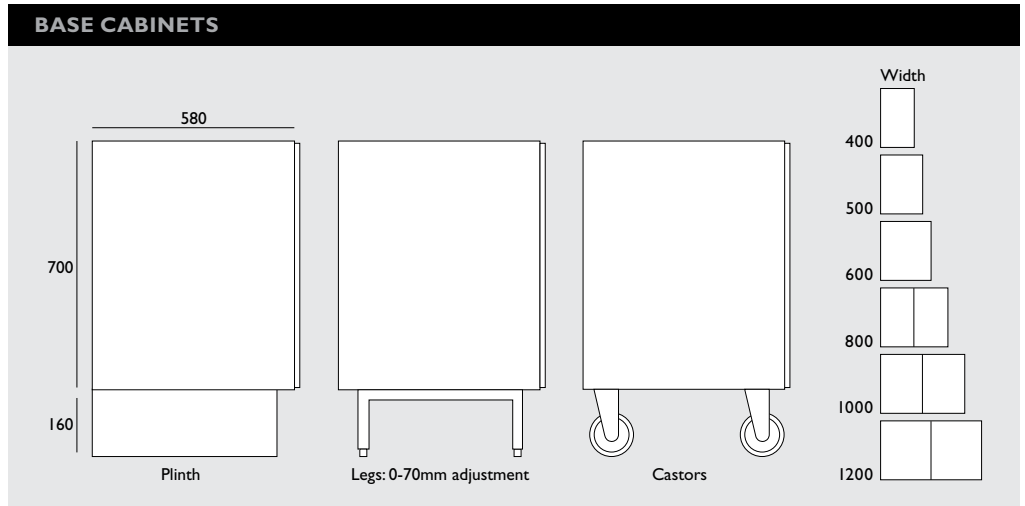

#### BASE CABINETS

GEC Anderson stainless steel base cabinets, drawer cabinets and wall cabinets provide sleek, robust and hygienic storage suitable for many environments and offer good stability and sound absorption. Base cabinets and wall cabinets have one vertically adjustable shelf. Plain doors with stainless steel 'D' handle are standard.

Doors are ultra-durable with double-skin construction and fully adjustable, high quality, quick-release, hinges. Drawers have smooth and accurate roller-bearing runners. Damped-action closing is standard.

#### Mounting

- Wall-fixed with up to 100mm clearance eg. for clearance of pipes and or cleaning
- Within GEC Anderson stainless steel legs
- Free-standing with adjustable feet and optional plinth
- *Braked castors (zinc-coated steel):* Ø125mm rubber tyre. Overall height: 160mm for mobile units

#### Options

- Continuous, integral, recessed handles (vertical or horizontal)
- Excluding handle (eg. for use with hardware, by others)
- Key-operated lock
- Fire-retardant core for fire-sensitive areas
- Individual drawers are available (eg. for mounting below worktops)
- Glass (clear, frosted, wired) door with stainless steel frame
- Door and drawer-fronts available separately
- Non-standard sizes

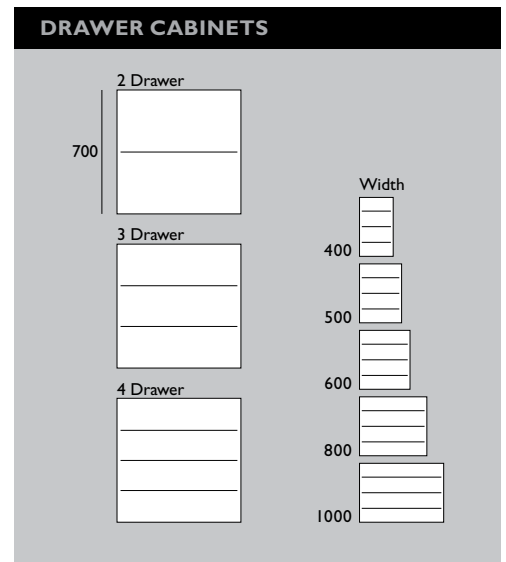
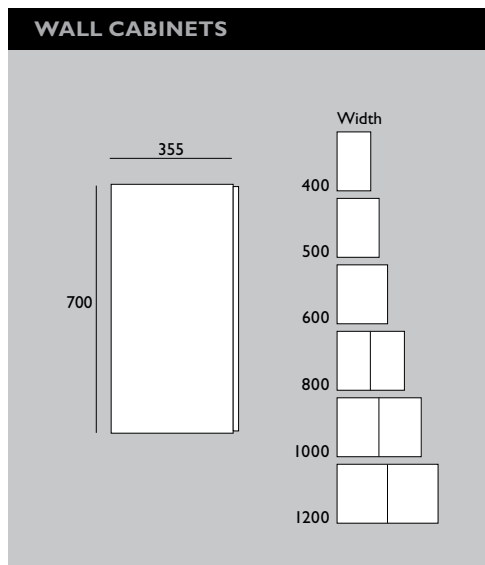

**COMPREHENSIVE,  
PROFESSIONAL, FRIENDLY  
AND EFFICIENT SUPPORT**

- **Technical advice and design guidance**  
*Available when you need it, regardless of project scale.*
- **Rapid product specification and quotation**  
*Assisting you with meeting deadlines and to safeguard specifications.*
- **Secure ordering procedures**  
*For added assurance and peace of mind.*
- **Pre-production CAD drawings**  
*For clarity, time-saving and added assurance.*
- **Dependable, on-time and co-ordinated deliveries**  
*Helping you to avoid costly delays and adhere to work-programs.*
- **Measuring and installation service**  
*Let us take care of it for you.*
- **Cleaning and maintenance guidance**  
*Full instructions and back up, including the E-cloth® system.*
- **Technical product literature**  
*Carefully designed for clarity and ease of reference.*
- **[www.gecanderson.co.uk](http://www.gecanderson.co.uk)**  
*Comprehensive product data; case studies and examples; news items; specification clauses and CAD drawings.*

Please contact us if we can help you in any way!

**ORDERING**

**Standard products**

Often available from stock. Simply provide product reference; quantity required.

**Special products**

Made to order.

- Please specify your requirements and/or refer to us for quotation and specification
- Upon receipt of order, we will issue our pre-production drawing to you, for approval
- A site visit will be arranged and dimensions and templates will be taken if GEC Anderson is installing for you
- As soon as your approval is obtained, your order will be placed into production
- We will confirm your order, in writing, to you with a confirmed delivery date
- Delivery, to the location of your choice, will be arranged and coordinated
- Installation will be pre-arranged where appropriate

Please indicate any delivery requirements or instructions.

Please ensure safe disposal of packaging.

For clarity and to minimise risk of errors, we ask for orders, in writing please.

**INSTALLATION AND  
MAINTENANCE**

Leave plastic surface protection in place until installation is complete. GEC Anderson recommends the E-cloth® system. Alternatively, wash with cold water and detergent. A fine scouring powder will remove persistent stains. Do not use coarse abrasive cleaners or bleach! Strong acids can mark and pit stainless steel.

**OTHER PRODUCTS  
FROM GEC ANDERSON**

**SANITARYWARE**

A comprehensive range of safe and highly durable stainless steel sanitary appliances

**DECIMETRIC®**

Professional quality, modular kitchen furniture system

*'The detailing for the sink area was a crucial element of the overall kitchen design. GEC Anderson was the only supplier able to create exactly what we were looking for and the client was delighted with the final result.'*

*Mark Levy, Northpoint Design*



**GEC Anderson Limited** Oakengrove Shire Lane Hastoe Tring Hertfordshire HP23 6LY  
Tel +44 (0)1442 82 6999 Fax +44 (0)1442 82 5999 [info@gecanderson.co.uk](mailto:info@gecanderson.co.uk) [www.gecanderson.co.uk](http://www.gecanderson.co.uk)