

AGGREGATE INDUSTRIES

Landscaping

Charcon Block kerb

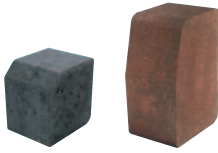

A popular range of edge restraint kerbing systems available from stock in a choice of colours.

- Designed to provide edge restraint in pedestrian and vehicular applications
- Colours complement Europa block paving
- Provides subtle alternative to more traditional kerbs
- Allows kerbing around irregular or complex shapes.

Applications

Block kerb is specifically designed for use where product appearance or colour matching to block paving is an important criteria.

Manufacturing standard

Block kerb is manufactured using a semi dry process and is manufactured in accordance with and complies with all relevant sections of BS EN 1340: Concrete Kerb Units – requirements and test methods.

Aggregate Industries fully operates an accredited Quality Assurance scheme, certified to BS EN 9001:2008 which is independently and regularly assessed by BSI (British Standards Institution). All Aggregate Industries manufacturing sites are also certified to BS EN 14001 Environmental Management Systems.

Performance with slip resistance

Unpolished slip resistance values, when tested in accordance with BS EN 1340, are available on request. All Aggregate Industries kerb units are classified as having a low potential for slip.

Polished slip resistance values can be provided on request.

Complementary products

Designed for use with Europa block paving.



Colour swatches

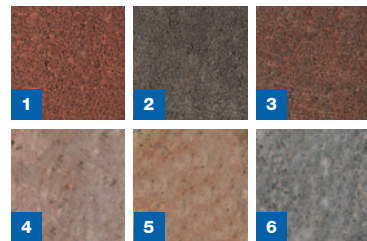

1. Red
2. Charcoal
3. Brindle
4. Rustic
5. Autumn
6. Graphite

Block kerb

Dimensions (mm)	Large	Small	Woburn
Length	100	100	100
Height	200	125	200
Width	125	125	125
Weight (kg)	5.2	3	5.2
Units/m (approx)	10	10	10
No. per pack	192	288	192
M/pack (approx)	19.2	28.8	19.2
Pack weight (T)	0.99	0.864	0.99
Colour available	Rd, Ch, Br	Rd, Ch, Br	Ru, Au, Gr

Rd – Red / Ch – Charcoal / Br - Brindle / Ru - Rustic / Au – Autumn / Gr – Graphite
Full range of accessories available.



Q10. For NBS clauses, refer to Aggregate Industries technical services

Charcon Block kerb

Small kerbs

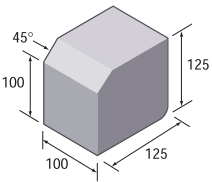

Main unit SK

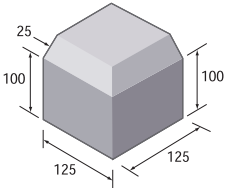

External angle SK/A

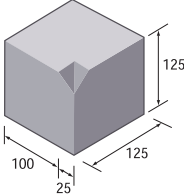

Internal angle SK/B

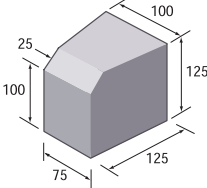

Internal radius SK/C

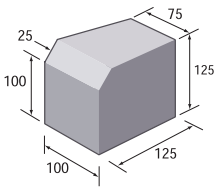

External radius SK/D

Charcon Block kerb

Large kerbs

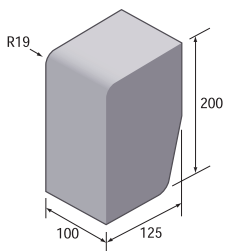

HB/BN Main unit LK

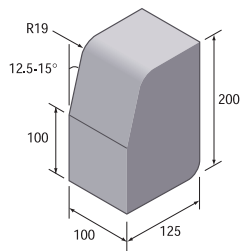

HB/BN Main unit LK

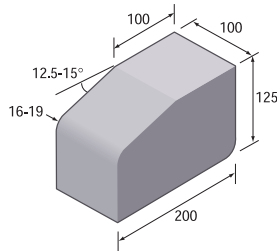

HB/BN Main unit laid Flat LK

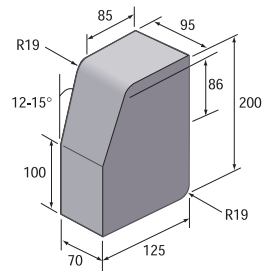

HB Internal radial block LK/A

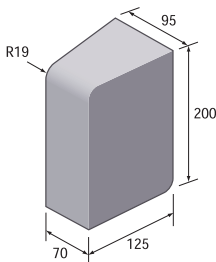

BN Upright internal/external radial block (internal shown) LK/B

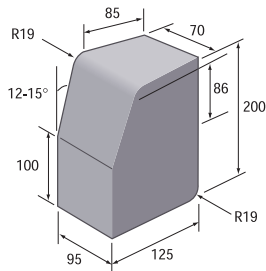

HB External radial block LK/C

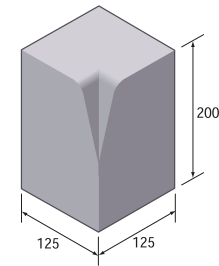

HB Upright internal angle LK/D

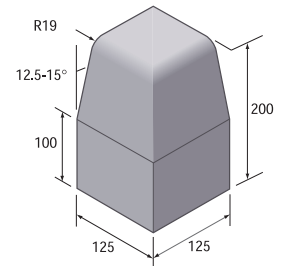

HB Upright external angle LK/E

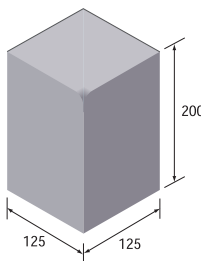

BN Upright internal angle LK/F

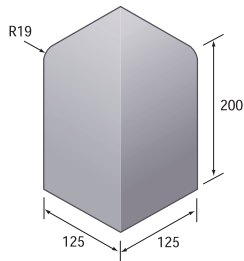

BN Upright external angle LK/G

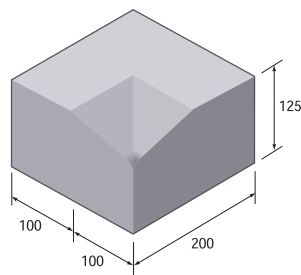

HB Flat internal angle LK/H

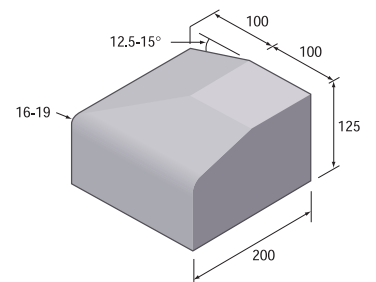

HB Flat external angle LK/J

Charcon Block kerb

Droppers and crossing units

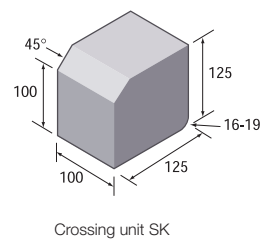
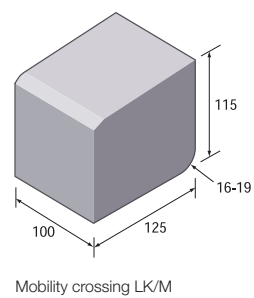
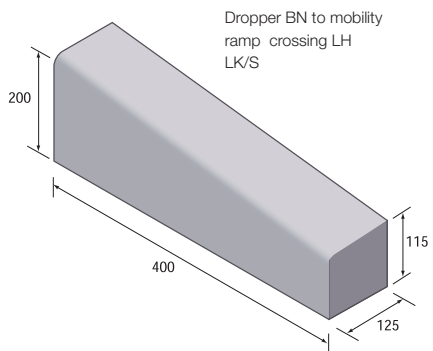
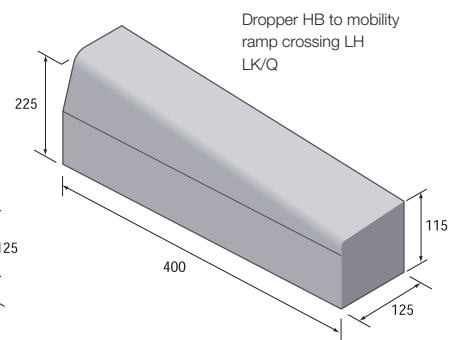
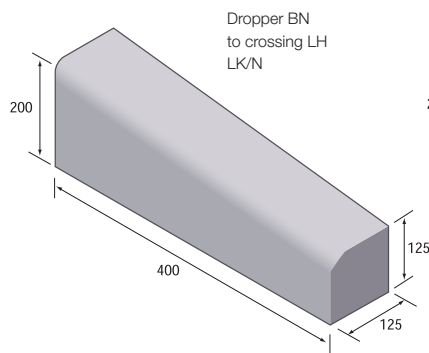
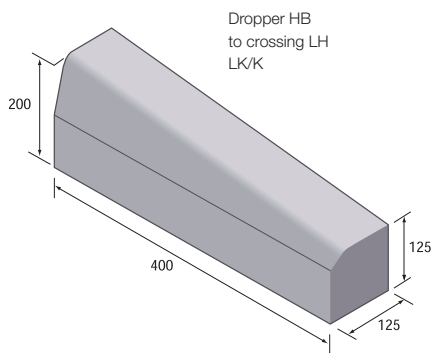

Charcon Block kerb

Sustainability and local sourcing

Energy use: Aggregate Industries is at the forefront of sustainability and has committed to reduce carbon emissions by 20% by 2016 based on a 2012 base line.

Recyclable: 100% of the product can be recycled thus reducing the amount of material that is sent to landfill.

Manufacturing location: Produced in the UK, with locally sourced materials under strict environmental and social legislation, for local supply.

Responsible sourcing: Aggregate Industries is the first company in the world to achieve a BES 6001:2008 Responsible Sourcing Certificate from BRE Global. Products are assessed on:

- quality management
- environmental management
- health and safety management
- greenhouse gas emissions
- minimising raw material usage
- labour practice
- biodiversity
- community engagement.

Key aggregates and recycled content

Block kerb is manufactured using high quality, hard wearing granite aggregates.

Generic green guide rating*

Not applicable.

Policies

Aggregate Industries' policies on the environment and community, health and safety and sustainable solutions for different product applications can be viewed on our website www.aggregate.com

Design and installation

For successful installation refer to BS 7533 Part 6. For specific design, installation and maintenance guidance, please contact our technical department on 01335 372222.

Maintenance and cleaning

Aggregate Industries can supply on request advice on specific stain removal and general maintenance, suitable cleaning products and referrals to specialist cleaning companies.

COSHH data

Full COSHH data on the Charcon range of products is available on request. Please call the technical helpline on 01335 372222.

Technical support

Detailed guidance and assistance with the preparation of specification of the Charcon range of hard landscaping products, including model clauses, is available through the sales office. A free technical design service is also available.

For further information, please refer to our technical services on 01335 372222.

*Ratings based upon generic green guide values (2009) supplied by BRE Global Ltd, www.thegreenguide.co.uk

Hulland Ward, Ashbourne,
Derbyshire DE6 3ET

Tel: 01335 372222

Fax: 01335 370074

www.aggregate.com



The information contained within this publication was accurate at time of production. However, Aggregate Industries reserves the right to introduce modifications or changes to detail at any time without notice. No charge is levied for this publication or advice therein, and accordingly the company, its employees and authorised agents can accept no liability whatsoever, either indirectly or directly arising from the use of its products in connection with any information or advice contained in this guide.